

FIND NEW ROADS™

CHEVROLET

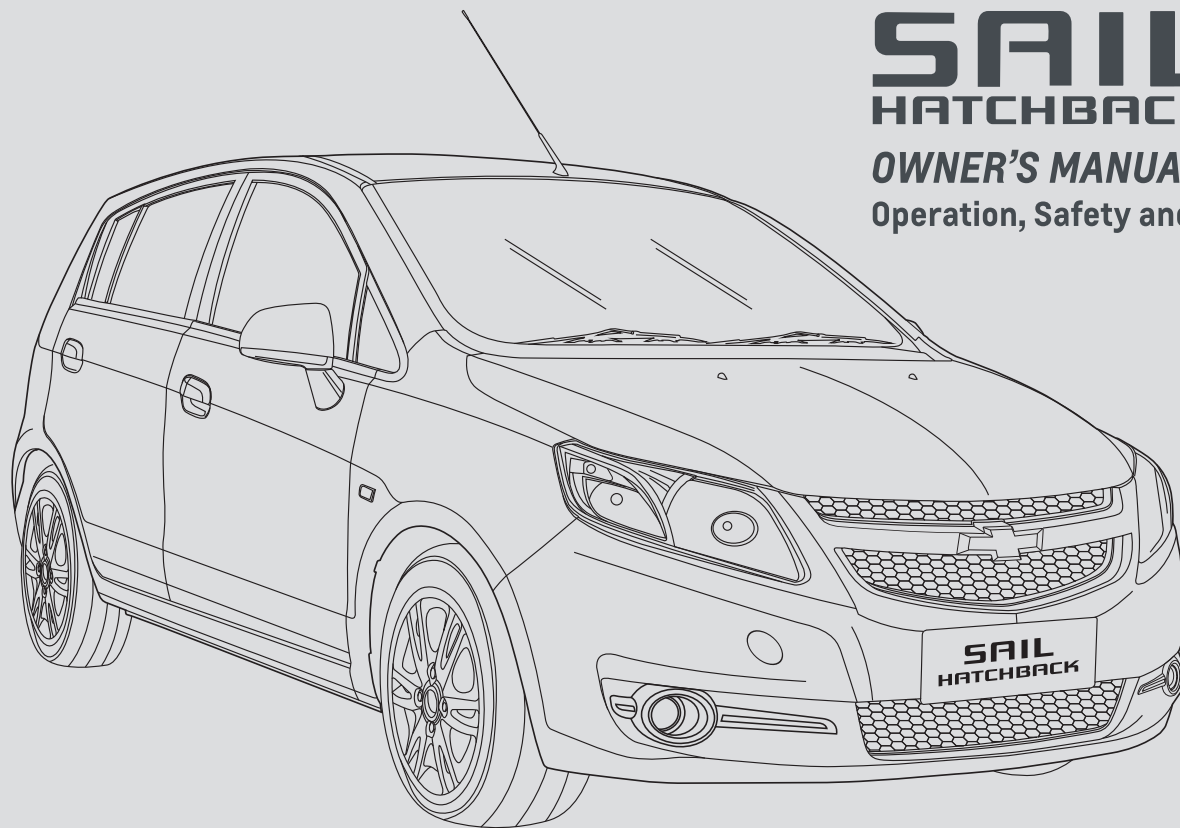

SAIL
HATCHBACK DIESEL
OWNER'S MANUAL
Operation, Safety and Maintenance

Dear Customer,

Welcome to the Chevrolet family. We wish to thank you for choosing Chevrolet Sail Hatchback.

It is our constant endeavor to provide you with products that offer excellent performance through out their ownership period. Which is why, in addition to offering great cars, we have also set up an extensive, and very well equipped network of retailers and authorized service centers across the country.

Naturally, these Chevrolet retailer know everything about your car and provides you with the best service possible. In fact, every retailer is equipped with the most advanced technology, technicians specially trained by us and genuine spares. Needless to say, they are also committed to ensure your complete satisfaction.

So, please contact a Chevrolet retailer for any servicing need and make sure that only genuine spares are used for your car.

This Manual will familiarize you with the operation and maintenance of your new vehicle. It will also provide you with important safety information. Please do read it carefully and follow the recommendations. In fact, the Manual is like a permanent part of your car. And it would go a long way in ensuring a safe and trouble-free operation for your car.

Should you have any query please feel free to call our 24 hr. Helpline at 1800 3000 8080 or email us at : gmi.cac@gm.com.

Happy Motoring

CONTENTS

Foreword	2
Introduction	5
Keys, Doors and Windows	15
Seats and Restraints	29
Storage	47
Instruments and Controls	51
Lighting	69
Climate Control System	73
Driving and Operating	85
Vehicle Maintenance	101
Technical Data	149
Service and Warranty	153
24x7 Roadside Assistance	183
Service Network	191

FOREWORD

Your vehicle is a designed combination of advanced technology, safety, environmental friendliness and economy.

This Owner's Manual provides you with all the necessary information to enable you to drive your vehicle safely and efficiently.

Make sure your passengers are aware of the possible risk of accident and injury which may result from improper use of the vehicle.

You must always comply with the specific laws and regulations of the country that you are in. These laws may differ from the information in this Owner's Manual.

When this Owner's Manual refers to a CHEVROLET retailer visit, we recommend your Chevrolet Service Partner.

All Chevrolet Service Partners provide first-class service at reasonable prices. Experienced mechanics trained by Chevrolet work according to specific Chevrolet instructions.

The customer literature pack should always be kept ready to hand in the vehicle.

Using this Manual

- “Introduction” contains a general instruction.
- The contents at the beginning of this Manual, and the index at the beginning of each chapter, will help you locate specific information.
- Directional data always refers to the direction of travel, such as left, right, front and back.
- The vehicle display screens may not support your specific language.
- Certain functions and configurations described in this Manual do not apply to all models, but are dependent on the specific model.
- The Manual contains the latest information available at the time of printing. General Motors India Pvt. Ltd. is responsible for revision and clarification of this Manual, and has reserved the rights to make changes without notice after printing of this Manual. Some pictures shown are purely schematic diagrams for reference only. If any picture does not match the physical object, the object itself is decisive.

Danger, Warnings and Cautions

Danger

Text marked  **Danger** provides information on risk of fatal injury. Disregarding this information may endanger life.

Warning

Text marked  **Warning** provides information on risk of accident or injury. Disregarding this information may lead to injury.

Caution

Text marked **Caution** provides information on possible damage to the vehicle. Disregarding this information may lead to vehicle damage.

Note: Text marked **Note** indicates a point to take into account when operating the vehicle. Failure to observe this may lead to incorrect operation.

⊗ : This is a safety symbol which means 'Do not', or 'Do not do this', or 'Do not let this happen'.

* **or (Option)** : The asterisk and (Option) in this Manual signify an item of equipment that is not included on all vehicles. Such items include engine options, model variations specific to one country, and optional equipment.

All information, illustrations, and specifications in this Manual are based on the latest product information available at the time of publication.

General Motors India Pvt. Ltd. reserves the right to change specifications or designs at any time without notice and without incurring obligation.

This vehicle may not comply with the standards or regulations of other countries. Before attempting to register this vehicle in any other country, check all applicable regulations and make any necessary modifications.

This Manual describes the options and trims available at the time of publication. Some of the items covered may

not apply to your vehicle. Contact your CHEVROLET retailer for information on options and trims availability.

Non Chevrolet Genuine Parts & Accessories have not been examined or approved by General Motors India Pvt. Ltd. We can certify neither the suitability nor the safety of Non Chevrolet Genuine Parts & Accessories and are not liable for damage caused by their use.

Warning : Tampering of wiring harness or fitment of non genuine accessories in your vehicle may lead to short circuit resulting in fire.

We wish you many hours of pleasurable driving **Chevrolet**.

INTRODUCTION

Initial Driving Information	5
Seat Adjustment	5
Adjust Front Head Restraints	6
Safety Belts	6
Rear View Mirror Adjustment	7
Instrument Panel Overview	8
Exterior Lighting	9
Horn	11
Windshield Washer/Wiper System..	11
Climate Control	12
Transmission	12
Starting the Vehicle	12
Parking	13

INITIAL DRIVING INFORMATION

Unlock Vehicle

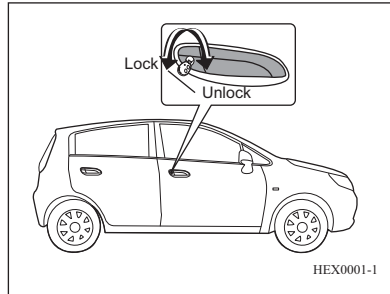

Use your key to unlock the vehicle from the driver door. Use the same key to unlock the rear compartment.

Driver door lock - Turn key clockwise to unlock and counter clockwise to lock the driver door.

Passenger door lock* - Turn key clockwise to lock and counter clockwise to unlock the passenger door. This will lock or unlock passenger door only.

Use the same key to unlock the rear compartment. Turn key clockwise to unlock the rear compartment.

SEAT ADJUSTMENT

Seat Position

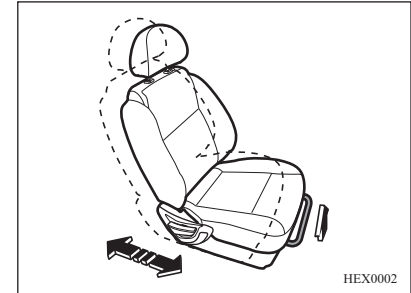

Lift the adjustment lever, slide the seat back and forth as required. Release the lever.

Seatback

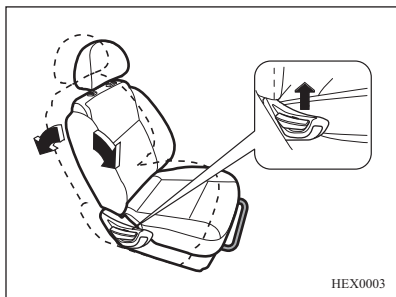

Lift the control lever, adjust the seatback to an appropriate position, and then release the control lever.

Do not lean against the seatback when making adjustments.

ADJUST FRONT HEAD RESTRAINTS

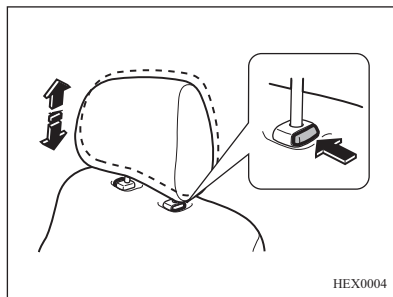

When adjusting the head restraint upwards, pull it up to the appropriate position and then fix. To pull out a head restraint completely, press the release button and take out the head restraint.

To lower a head restraint, push the release button and push the head restraint down to the desired position, and then release the button and secure.

SAFETY BELTS



Pull out the safety belt strap and insert it into the buckle. The belt strap must not be twisted and must be worn fitted closely against the body. The seatback should not be excessively reclined.

To release the safety belt, push the red button on the buckle.

REAR VIEW MIRROR ADJUSTMENT Interior Rear View Mirror

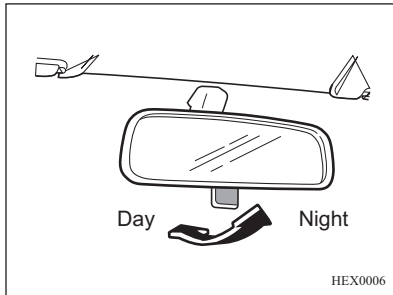

The interior rear view mirror can be adjusted manually.

Your vehicle has interior rear view mirror with day and night adjustment mode to prevent dazzling.

Exterior Rear View Mirrors

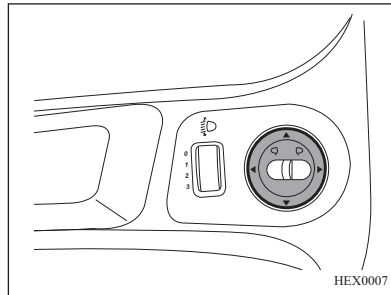

Select the corresponding exterior rear view mirror and adjust its position.

See Exterior Rear View Mirrors on page 23.

8 Introduction

INSTRUMENT PANEL OVERVIEW

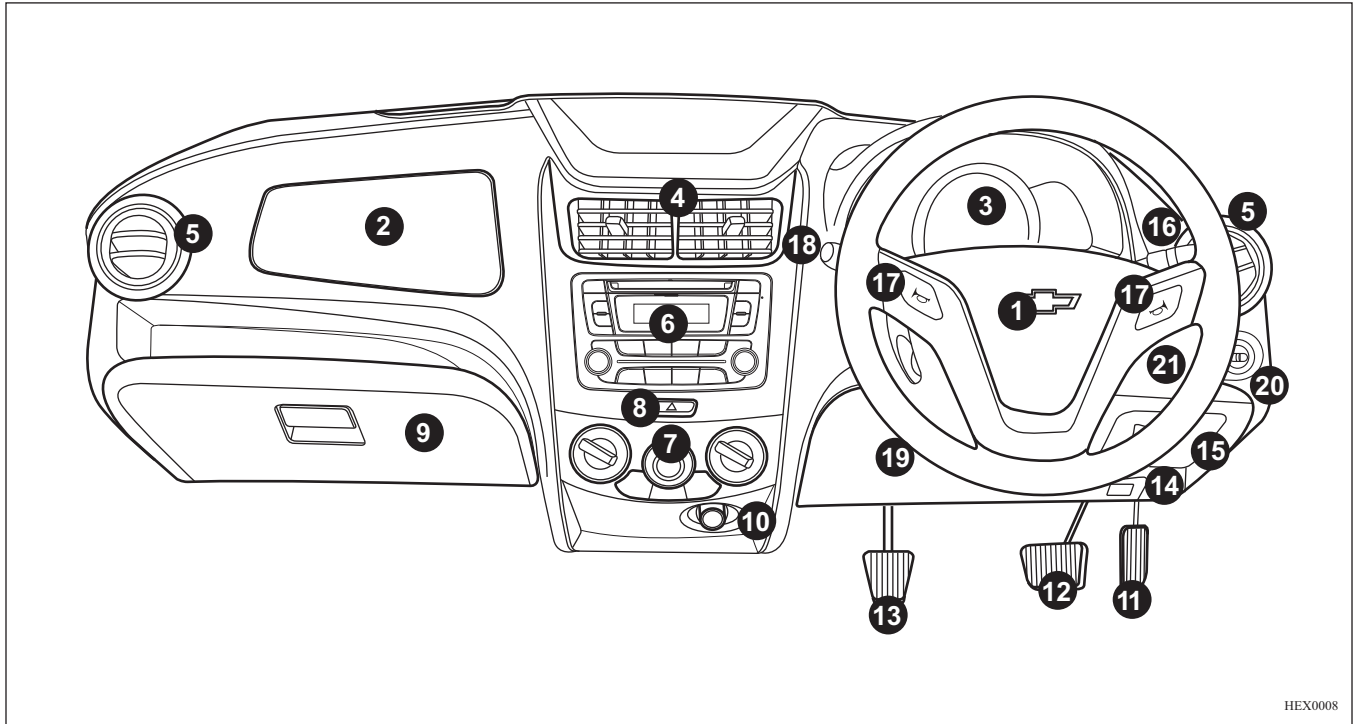

1. Driver side airbag*
2. Front passenger side airbag*
3. Instrument cluster
4. Center air vents
5. Side air vent
6. Audio system*
7. Climate control system
8. Hazard warning flashers switch
9. Glove box
10. Accessory power outlet
11. Accelerator pedal
12. Brake pedal
13. Clutch pedal
14. Hood release handle
15. Instrument panel storage
16. Headlight switch
17. Horn
18. Windshield wiper switch
19. Steering wheel adjustment lever
20. Power rear view mirror adjustment switch
21. Headlamp range adjustment switch

EXTERIOR LIGHTING

Headlight Switch

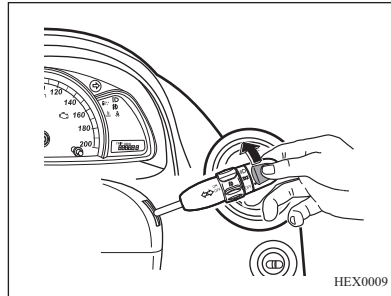

Twist the combination switch lever to

OFF = Turn all lights off

 = Parking lights

 = Headlights

Front Fog Lights*

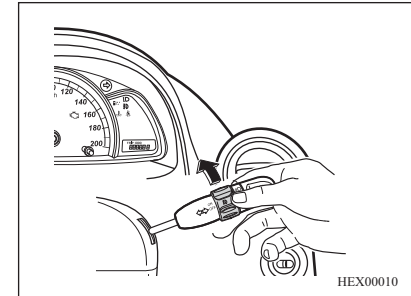

Your vehicle may be equipped with front fog lights.

While the headlights are on parking light or low beam position, turn the ring in the middle of the combination switch control lever to ON, to turn on the front fog lights.

Turn the ring to OFF position to turn off the front fog lights.

Under severe conditions (such as in a thick fog or snow), the fog lights provide extra illumination to the sides of the road ahead and improve the visibility.

Headlight Flash, High Beam and Low Beam

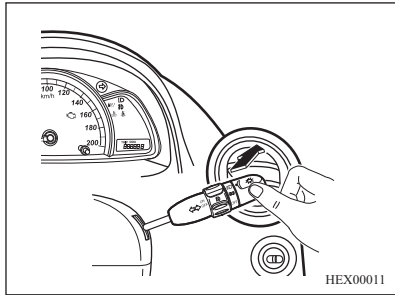

- Headlight flash = Pull the control lever
- High beam = Push the control lever
- Low beam = Pull the control lever back from high beam position

Turn and Lane Change Signal

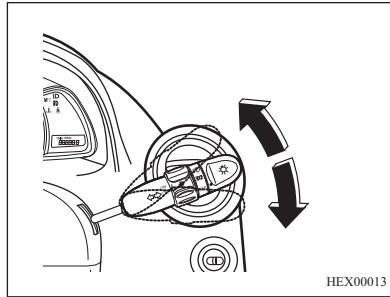

- Lever up = Left indicator
- Lever down = Right indicator

Hazard Warning Flashers

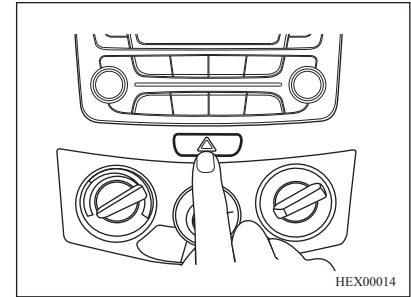

Press the \triangle switch to turn on or turn off the hazard warning flashers.

HORN

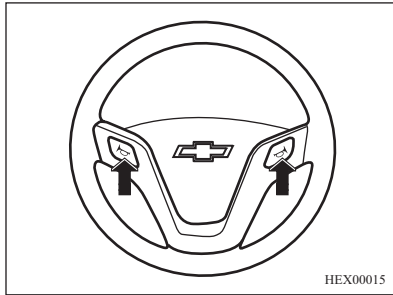

Press the  switch on the steering wheel pad to sound the horn.

WINDSHIELD WASHER / WIPER SYSTEM Windshield Wipers

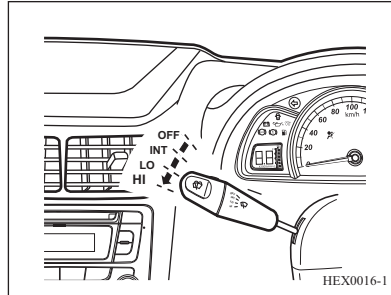

OFF : System off

INT : Intermittent operation

LO : Wiping continuously at low speed

HI : Wiping continuously at high speed

Windshield Washer System

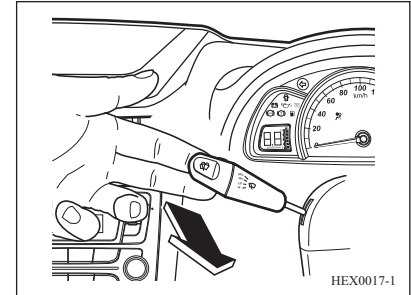

Pull the control lever towards you, as shown in the picture to wash the windshield.

CLIMATE CONTROL

Rear Window Defrost Function*

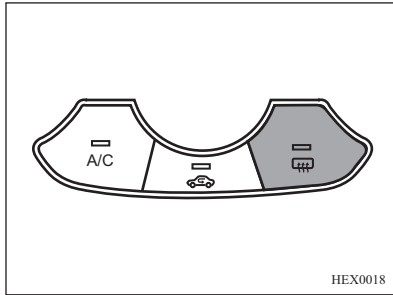

Press the  button to operate the rear window defrost function.

Indicator light on the button will illuminate.

Press the  button again, to turn off the rear window defrost function.

TRANSMISSION

Manual Transmission

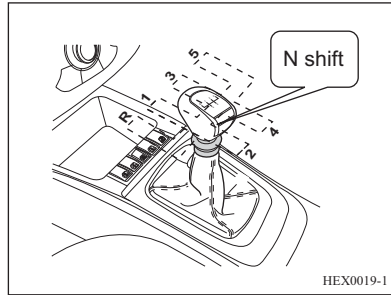

To change gears, fully depress the clutch pedal, move the gearshift lever into gear according to the gear position marked on gear knob and slowly release the clutch.

To engage reverse, with the vehicle stationary pull up the ring on the selector lever and engage the gear.

STARTING THE VEHICLE

Checking Before Starting Off

- Tire pressure and conditions.
- Engine oil level and other oil/fluid levels.
- All the windows, rear view mirrors, exterior lights and the license plate lights are working properly, free from dusts, snow or ice.
- The seats, safety belts and rear view mirrors are in the correct position.
- Check the brake function at low speed, especially when the brake is wet.

Starting Engine with the Ignition Switch

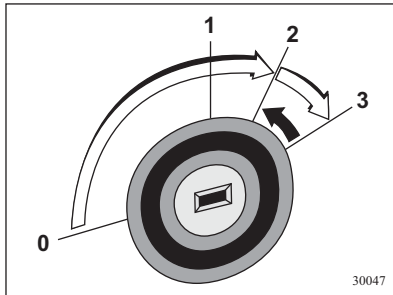

- Turn key to position 1, while turning the steering wheel slightly from left to right to release the steering wheel lock.
- Manual transmission: Operate clutch.
- Do not press accelerator pedal.
- Turn key to position 2 for preheating until glow plug indicator  goes out.

- Turn key to position 3 depressing the clutch pedal and foot brake then release when engine is running.

Before restarting or to switch off the engine, turn key back to 0 or 1.

PARKING

- Do not park the vehicle on an easily flammable surface. The high temperature of the exhaust system could ignite the surface.
- Always apply parking brake without pressing release button. Apply as firmly as possible on downhill or uphill slopes. Depress the footbrake at the same time to reduce operating force.
- After running at high engine speeds or with high engine loads, operate the diesel engine briefly at a low load or run in neutral for about 1 to 2 minutes at idle speed before switching off in order to protect the turbo charger.
- When parking the vehicle on level ground or on a slope, engage first gear before turning OFF the ignition switch. When the vehicle is parked on an uphill slope, turn the front wheels away from the curb.
- When parking the vehicle on a downhill slope, engage reverse gear

14 Introduction

before turning OFF the ignition switch. Turn the front wheels towards the curb.

- Turn OFF the engine and ignition switch.
- Close the windows.
- Lock the vehicle.

Note

The engine cooling fan may continue to run after the engine is shut down.

KEYS, DOORS AND WINDOWS

Keys	15
Remote Keyless Entry*.....	16
Transmitter	17
Battery Replacement	17
Door Locks	18
Child Safety Locks	19
Central Locking System*.....	20
Automatic Locking*	20
Automatic Unlocking*	20
Doors	21
Tailgate	21
Tailgate Release Lever	21
Hood	22
Exterior Rear View Mirrors	23
Power Rear View Mirrors	23
Folding Mirrors	23
Interior Rear View Mirror	24
Windows	24
Power Windows*	24
Power Window Lockout Button*.....	26
Manual Windows*	26
Sun Visors	27

KEYS

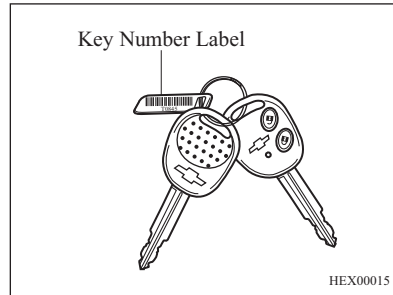

Each new vehicle comes with two keys. Please keep one key as the backup key. The key number is imprinted on the key number label. For security purpose, please keep your key number label in a safe place rather than inside your vehicle. In addition, the key number should be recorded in a safe place outside the vehicle.

Unauthorized key copies can be prevented by these precautions.

Caution

Do not leave your key inside the vehicle.

Take away the key when you leave the vehicle.

Note

A substitute key can be obtained by giving your key number to your CHEVROLET retailer if you lose your key.

Warning

Leaving children in a vehicle with the ignition key is dangerous for many reasons. Children or others could be badly injured or even killed. They could operate the power windows or other controls or even make the vehicle move.

The windows will function with the key in the ignition and children could be seriously injured or killed if caught in the path of a closing window. Do not leave the keys in a vehicle with children.

REMOTE KEYLESS ENTRY*

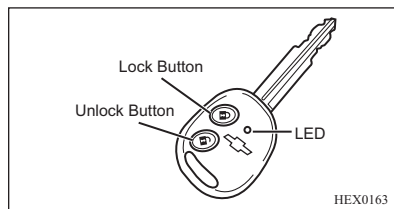

Remote Keyless Entry allows you to lock and unlock doors using the transmitter within valid operating range. The LED on the transmitter flashes to indicate an effective operation.

- **Lock Button:** Press to lock doors. The hazard warning lamps will flash once and the horn will sound.
- **Unlock Button:** Press to unlock doors. The hazard warning lamps will flash twice.

Note

If any of the door is not locked properly and Lock button is pressed, hazard warning lamps will flash thrice to indicate that door is not locked properly.

Note

The transmitter operating range depends on the environmental conditions.

Note

Lock and Unlock buttons are disabled while the key is in the ignition switch.

Note

Only one key is provided with RKE transmitter. The spare key provided is without RKE transmitter.

Warning

Do not lock the vehicle if anyone is to be left inside the vehicle.

Never leave children or pets unattended in your vehicle. The temperature inside the vehicle can increase more rapidly and reach much higher levels than the temperature outside.

This can result in serious injury or death.

Transmitter

Each transmitter must be programmed to prevent the vehicle from unlocking with other transmitters.

Only RKE transmitters programmed to this vehicle will work. If a transmitter is lost or stolen, a replacement can be purchased and programmed through your CHEVROLET retailer. When the replacement transmitter is programmed to this vehicle, all remaining transmitters must also be reprogrammed. Any lost or stolen transmitter will no longer work once the new transmitter is programmed.

Each vehicle can have up to four transmitters programmed to it.

Note

If Unlock button is pressed and door is not opened within 30 seconds, doors will be locked automatically.

Battery Replacement

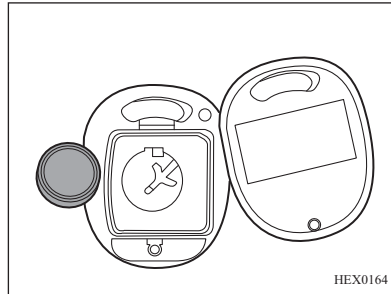

If the LED fails to illuminate or the range is noticeably diminished, it is an indication that a new battery is needed.

Note

Replace with CR1616 battery or equivalent.

1. Remove the screw from the back of the transmitter cover.
2. Open the transmitter cover.

3. Pull the transmitter out of the cover and remove the label carefully, then keep it in the clean place.
4. Remove the old battery. Prevent the circuit board from contacting other components.
5. Install the new battery. Make sure that negative (-) side faces towards the base.
6. Stick the label and put the transmitter in the cover.
7. Install the transmitter cover.
8. Check the operation of the transmitter.

Caution

Do not touch the battery surface with your fingers. Otherwise, it will shorten the life of battery.

Caution

Old lithium battery will pollute the environment.

Dispose the battery according to the local recycling regulation.

Do not dispose the battery with domestic wastes.

Caution

To ensure proper operation of the transmitter, do the following instructions:

- Prevent the transmitter dropping.
- Do not put any heavy objects on the transmitter.
- Prevent the transmitter from the water and the direct sunlight. If the transmitter contacts the water, dry it with soft cloth.

DOOR LOCKS

Caution

Do not leave children or pets alone in the vehicle.

Serious injuries could occur. The children could operate the power windows or other controls and could even make the vehicle move.

Do not leave children in the vehicle with the ignition key. This can lead to serious injury or accidents.

Caution

When leaving an unattended vehicle you must lock all the doors and take away your key.

Your vehicle could be stolen if the door is not locked.

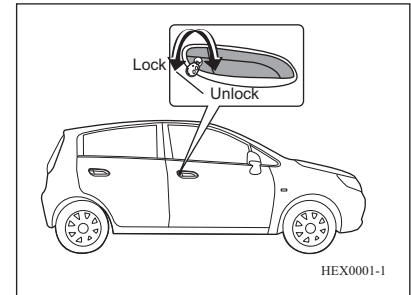

Driver door lock - Turn key clockwise to unlock and counter clockwise to lock the driver door.

Passenger door lock* - Turn key clockwise to lock and counter clockwise to unlock the passenger door. This will lock or unlock passenger door only.

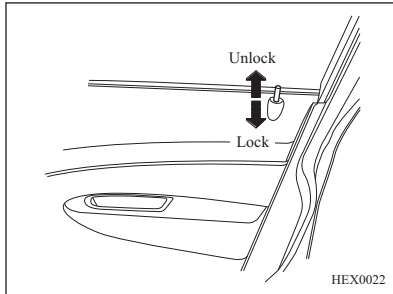

To lock the door from inside, press the door lock knob.

To unlock the door from inside, pull out the door lock knob.

Note

The driver's door lock knob cannot be pressed when the driver's door is open. This prevents the door from being locked if you accidentally leave your key in the vehicle.

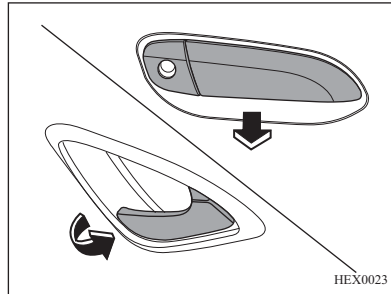

To open the door from outside or inside, pull the door handle.

Note

Apply lubricants at the door latches and hinges if there is noise when opening/closing the door or during driving.

Child Safety Locks

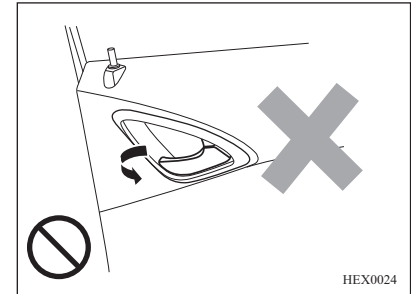

Each rear door of this vehicle is equipped with a child safety lock.

The child safety lock is intended to prevent the rear doors from being accidentally opened by passengers (especially children) pulling the door handles from inside.

Caution
<p>When the child safety lock is set at LOCK position, do not pull the door handle from inside the vehicle. The handle could be damaged otherwise.</p>

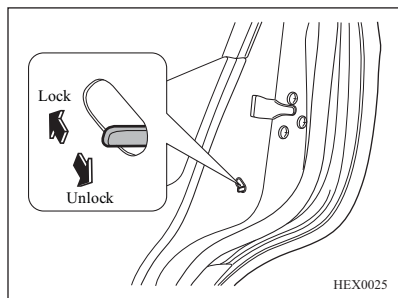

To activate a child safety lock:

1. Open the rear door you want to lock.
2. Find the child safety lock lever near the centre position on the door.
3. Slide the lever to LOCK position.

Note

Each rear door has its individual lock. The child safety locks for the rear doors must be individually, manually activated.

To open the rear door when the child safety lock is activated, unlock the door from inside by pulling up the door unlock knob and then open the door from outside.

To deactivate the child safety lock, place the control lever to UNLOCK position.

Warning

Use the child security door locks whenever children are occupying the rear seats.

CENTRAL LOCKING SYSTEM*

You can activate the central locking system from the driver's door. This system will allow you to lock or unlock all the doors at once by using your key (from outside) or the driver's door lock knob (from inside).

Automatic Locking*

If this feature is equipped, all the doors will be automatically locked once the vehicle starts moving. The tailgate or the fuel filler cap cannot be locked automatically, as they are manually operated.

Automatic Unlocking*

When the ignition switch is in ON position and the doors are locked, turn the key to LOCK position and all the doors will be unlocked automatically. Depending on models, some vehicles will only unlock the doors other than the driver's door.

DOORS

Tailgate

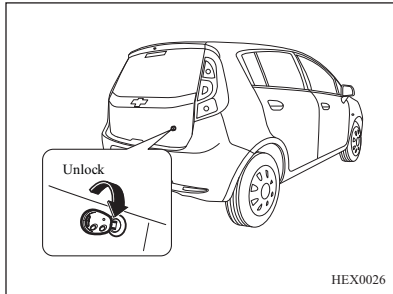

Insert the key and turn it clockwise to unlock the tailgate. Lift the tailgate.

The tailgate will be automatically locked when the tailgate is pushed down and closed.

Be sure that no-one's hands or any part of the body are within the closing area of the tailgate.

Caution

When opening or closing the tailgate, be sure to check it is free from obstructions.

Tailgate Release Lever

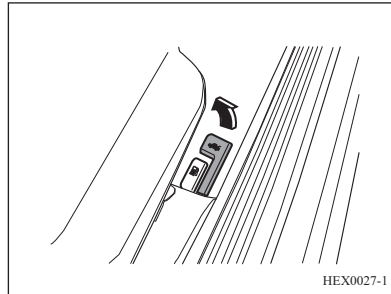

You can open the tailgate by pulling the tailgate release lever which is mounted on the floor to the right of the driver seat.

Warning

Exhaust gases can enter the vehicle if it is driven with the tailgate or trunk/hatch open, or with any objects that pass through the seal between the body and the trunk/hatch or tailgate. Engine exhaust contains carbon monoxide (CO) which cannot be seen or smelt. It can cause unconsciousness and even death. See Engine Exhaust on page 98.

Hood

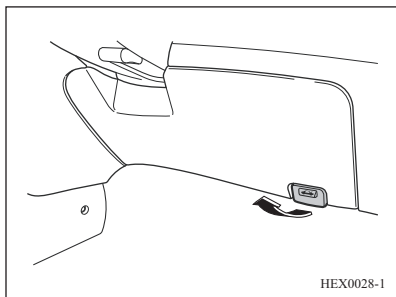

To open the hood -

1. Pull the hood release handle located in the lower right of instrument panel.

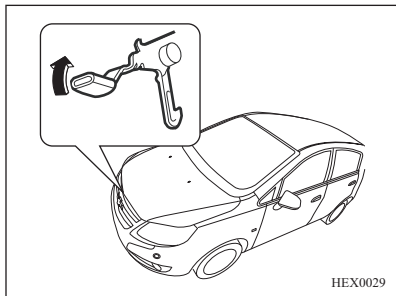

2. Reach under the front edge of the hood and lift the hood release handle.

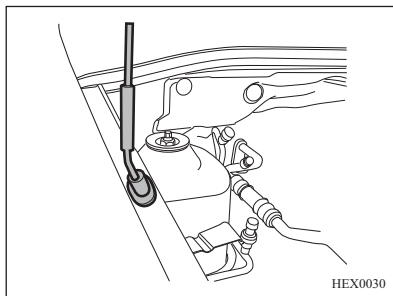

3. Release the hood support rod from the fixing clip.

Turn the hood support rod down and insert its free end firmly into the recess on the fender.

⚠ Warning

Only perform engine compartment checks when the ignition is OFF. The cooling fan may start operating even if the ignition is OFF.



Caution

The following precautions must be observed:

- Before driving, pull and check the front edge of the hood to ensure that the hood is securely locked.
- Do not pull the hood release handle while the vehicle is in motion.
- Do not drive the vehicle with the hood open. An open hood will obstruct the driver's vision.

Driving with an open hood could lead to collisions that will damage your vehicle and other property and cause casualties.

To close the hood -

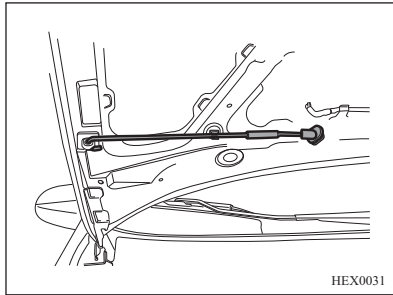

1. While holding the hood to prevent it from falling, remove the hood support rod from the recess and press it firmly into the fixing clip.
2. Be sure that no-one's hands and any part of the body are close to the engine compartment and the hood edge on the vehicle body.
3. Lower the hood, allowing it to drop from a height of about 30cm (1 foot).
4. Make sure that the hood is securely locked.

EXTERIOR REAR VIEW MIRRORS

Power Rear View Mirrors

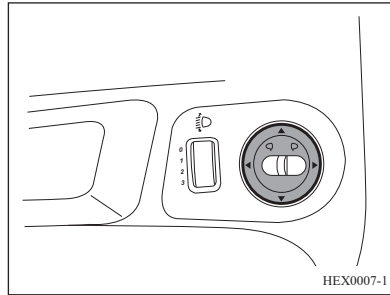

The exterior rear view mirrors can be adjusted by using the mirror switch that is located on the instrument panel to the right side of the steering wheel. The ignition switch must be at ACC or ON position for this feature to work.

1. Choose the left or right mirror by moving the switch to the left or right.
2. Adjust the selected mirror in four directions by pushing the edges of the control.

Folding Mirrors

Manually fold the outside mirrors in, to prevent damage when going through an automatic car wash or for pedestrian safety. To fold, while sitting in the vehicle, pull the mirrors towards the vehicle. Push out, to return the mirrors to their original position.

Warning

Always keep your mirrors properly adjusted, and use them while driving to increase your visibility of objects and other vehicles around you. Do not drive while either outside rearview mirror is folded back.

Caution

Do not operate mirror continuously while the engine is not running. This will discharge the battery.

INTERIOR REAR VIEW MIRROR

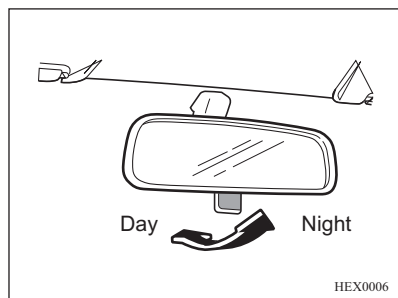

The interior rear view mirror can be manually adjusted in four directions.

Interior rear view mirror can be adjusted to day/night mode to reduce glaring from the following vehicles. Use the adjustment lever to adjust day and night mode.

Warning

Your view through the mirror may lose some clarity when it is adjusted for night vision.

Take special care with using your inside rearview mirror when it is adjusted for night vision.

Failure to ensure a clear rear view while driving may result in a collision causing damage to your vehicle or other property, and/or personal injury.

WINDOWS

Power Windows*

If the vehicle is equipped with power windows for four doors, the power window switches are located on the center console between the front seats, from left to right in following sequence:

- Left front window switch
- Left rear window switch
- Power window lockout button
- Right rear window switch
- Right front window switch

You can operate the power window switches when the ignition is ON. There is also a switch on each rear door armrest for rear seat passengers to operate the rear windows.

Some vehicles are equipped with manual windows for rear doors. For these vehicles, there are two power window switches to operate the front power windows in below sequence from left to right.

- Left front window switch
- Right front window switch

⚠ Warning

Do not operate the power window switch with no purpose.

⚠ Warning

Take care when operating the power windows. Risk of injury, particularly to children.

If there are children on the rear seat, switch on the power window lockout button for the power windows.

Keep a close watch on the windows when closing them.

Ensure that nothing becomes trapped in them as they move.

⚠ Warning

Body parts outside vehicle can be struck by passing objects. Keep all parts of body inside vehicle.

Children can operate and become entrapped in power windows.

Do not leave your keys or unattended children in your car.

Serious injury or death can occur from misuse of power windows.

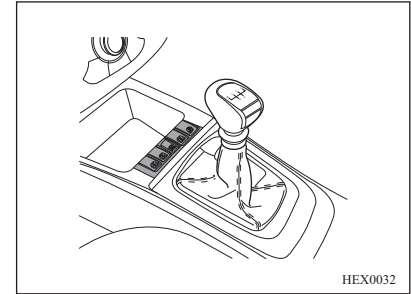

Pull the switch to raise the window. Press the switch to lower the window. Release the switch when the window reaches a desired position.

Caution

Leaning out of the vehicle can lead to injuries caused by passing objects.

Do not lean any part of your body out of the vehicle.

Note

The rear windows cannot be fully opened.

Power Window Lockout Button*

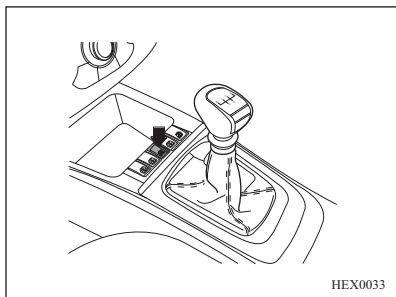

The power window lockout button can lock out the rear window switches. The rear windows can only be operated by the front switches after this button is locked.

Caution

Children could operate the power windows and become trapped by the windows, resulting in serious injuries.

Use the power window lockout when children are traveling in the rear seats.

Manual Windows*

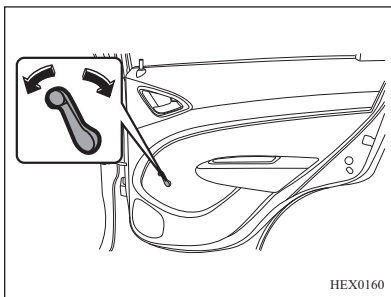

To raise or lower the windows, turn the window regulator handle on the door panel.

Be sure there is no object in the opening before closing the windows.

Caution

Leaning out of the vehicle can lead to injuries caused by passing objects.

Do not lean any part of your body out of the vehicle.

Caution

The unattended vehicle could be stolen with the windows open.

Close all the windows before leaving the vehicle.

Note

The rear windows cannot be fully opened.

Warning

Leaving children, helpless adults, or pets in a vehicle with the windows closed is dangerous.

They can be overcome by the extreme heat and suffer permanent injuries or even death from heat stroke. Never leave a child, a helpless adult, or a pet alone in a vehicle, especially with the windows closed in warm or hot weather.

SUN VISORS

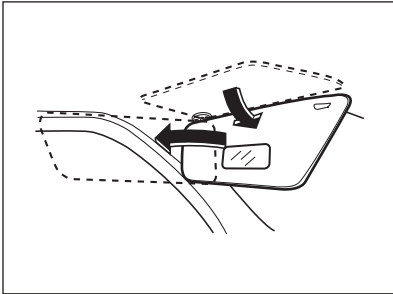

Your vehicle is equipped with sun visors to protect the driver and passengers from dazzling.

The sun visors can be folded down or swivelled to the side to prevent dazzling.

The passenger side sun visor has vanity mirror.

⚠ Warning

Do not place the sun visor in such a manner that it obscures visibility of the roadway, traffic or other objects.

SEATS AND RESTRAINTS

- Head Restraints 29
 - Head Restraint Position..... 29
 - Front Seat Head Restraints..... 29
- Front Seats 30
 - Seat Position 30
 - Seat Adjustment 30
 - Seatback 31
- Rear Seats 32
 - Folding the Rear Seatbacks 32
- Safety Belt 32
 - Safety Belt Care 33
 - Three-Point Seat Belt 34
 - Seat Belt Release..... 34
 - Safety Belt Use During
 - Pregnancy 35
 - Lap Belt 35
 - Belt Force Limiter 35
 - Front Seat Belt Pretensioner * .. 35
- Child Restraints* 36
 - Child Restraint Systems 37
 - Selecting the Right System 37
 - Securing a Child Restraint
 - By Using ISOFIX * 38
 - Securing a Child Restraint
 - Using Seat Belt * 39
 - Airbag System* 40
 - Correct Seating Position..... 41
 - Front Airbag System* 44

HEAD RESTRAINTS Head Restraint Position

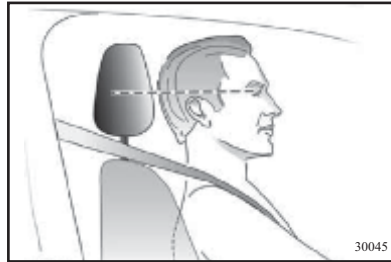

The center of the head restraint should be at eye level of the occupants. If this is not possible for extremely tall people, set to highest position, and set to lowest position for short people.

Warning

Only drive with the head restraint set to the proper position.
 Removed or improperly adjusted head restraints can result in serious head and neck injuries in case of a collision.
 Make sure that the head restraints are properly adjusted before driving.

Front Seat Head Restraints Height adjustment

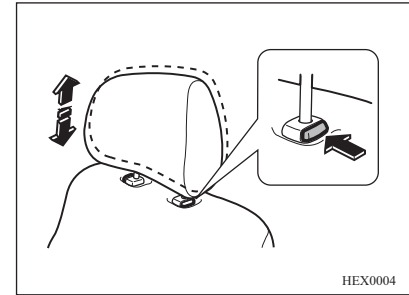

When adjusting the head restraint upwards, pull it up to the appropriate position and then secure. Press the release button to remove the head restraint out.

To lower a head restraint, press the release button and push down the head restraint to the desired position, and then release the button and secure.

FRONT SEATS

Seat Position

⚠ Warning

Seats must be properly adjusted before driving.



- It is advised to sit right back on the seat. Adjust the distance between the seat and the pedals properly so that your legs are slightly bent when pressing the pedals. Seats for passengers should be slid back as far as possible.
- Lean your shoulders against the seatback as much as possible.

- Adjust the seatback to ensure that the steering wheel is within easy reach with arms slightly bent.

When turning the steering wheel, keep your shoulders against the seatback. The seatback should not be angled too far back. The maximum recommended rake is around 25 degrees.

- Set the seat at a desired position where the driver has a clear view in all directions and of all display instruments.

The distance between the head and the headlining should be at least the width of one hand.

Thighs should be comfortably supported on the seat.

⚠ Danger

Do not sit nearer than 25cm (10in) to the steering wheel, to permit safe airbag deployment.

Seat Adjustment

⚠ Warning

Do not adjust the driver's seat while the vehicle is moving.

Driver could lose control of the vehicle and injury or property damage could result.

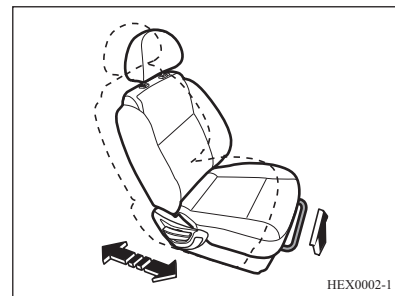

Pull the handle up and slide the seat forward or backward to an appropriate position, then release the handle. Slide the seat forward and backward to ensure it is locked in the appropriate position.

Seatback

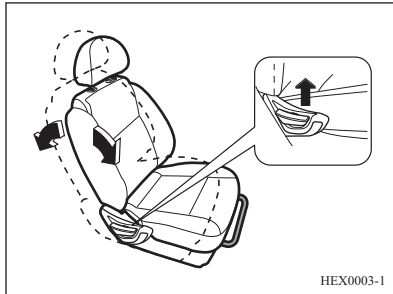

Lift the lever, adjust the seatback to an appropriate position, then release the lever.

After the adjustment, lean back against the backrest to make sure that the seatback has been locked in an appropriate position.

Do not lean against the seatback when making adjustments.

⚠ Warning

You can lose control of the vehicle if you try to adjust a driver seat while the vehicle is moving.

Adjust the driver seat only when the vehicle is not moving.

⚠ Warning

If either seatback is not locked, it could move forward in a sudden stop or crash. That could cause injury to the person sitting there. Always push and pull on the seatbacks to be sure they are locked.

⚠ Warning

Things you put on this seatback can strike and injure people in a sudden stop or turn, or in a crash. Remove or secure all items before driving.

⚠ Warning

Sitting in a reclined position when the vehicle is in motion can be dangerous. Even when buckled up, the safety belts cannot do their job.

The shoulder belt will not be against your body. Instead, it will be in front of you. In a crash, you could go into it, receiving neck or other injuries.

The lap belt could go up over your abdomen. The belt forces would be there, not at your pelvic bones. This could cause serious internal injuries.

For proper protection when the vehicle is in motion, have the seatback upright. Then sit well back in the seat and wear the safety belt properly.

REAR SEATS

Folding the Rear Seatbacks

Caution

Do not stack the luggage or other cargo to a height that is higher than the front seats.

Do not let passengers sit on the folded seatbacks while the vehicle is moving.

When braking suddenly or in an accident, unsecured passengers or cargo on the folded seatbacks could be impacted inside the vehicle or ejected from the vehicle, resulting in serious injuries.

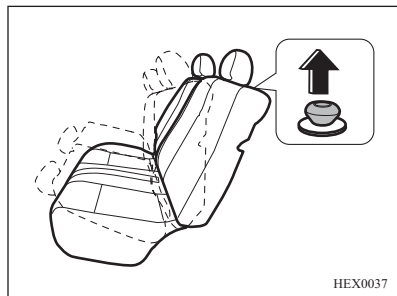

To fold the left and right rear seatbacks for much more rear compartment space:

1. Pull the release knob on the top of the rear seatbacks.
2. Fold the rear seatbacks forward. It may need to move the front seats forward slightly to leave more space, and then they can be put down horizontally.

To fold the rear seatbacks to their original position:

1. Lift the rear seatbacks to push them to their original position and then lock the seatbacks. Be sure the safety belt is out of the way.
2. Pull the seatbacks forward again to make sure they are locked firmly.

Caution

When the rear seats are occupied, make sure that the rear seatbacks are in the rearmost position and locked before driving.

Do not pull the release knob on top of the seatbacks while the vehicle is moving.

SAFETY BELT



Warning

Fasten your safety belt each time before driving. In case of an accident, passengers not wearing safety belts may be injured.

The safety belt is designed to be used by one passenger at a time. Check regularly all the parts of the safety belt system for damage or malfunction and replace the damaged parts.

In the event of an accident, contact your CHEVROLET retailer to replace the safety belts.

⚠ Warning

Sitting in a reclined position when your vehicle is in motion can be dangerous. Even if you buckle up, your safety belts can't do their job when the seatback is excessively reclined. In order to gain the full benefit of a safety belt, you must wear it correctly and position yourself correctly within your seat.

⚠ Warning

Wearing a safety belt improperly could cause serious injury.

Make sure the seatback is in the upright position.

Wear your safety belt closely against the body. Do not wear your shoulder belt under your arm, around your neck, over an inside shoulder or behind your back.

⚠ Warning

If a hard or breakable object is between a safety belt and an occupant, such as a ballpoint pen or glasses in a pocket, the occupant can be injured in the event of a collision.

⚠ Warning

Improper use of a safety belt can cause serious injury. Do not modify the safety belt. Do not add any device which would affect the operation of the safety belt.

⚠ Warning

Before you close the door, make sure the safety belt is out of the way. Otherwise, the belt and/or the vehicle body could be damaged.

Safety Belt Care

Keep belts clean and dry.

⚠ Warning

Do not bleach or dye safety belts. It may severely weaken them. In a crash, they might not be able to provide adequate protection. Clean safety belts only with mild soap and lukewarm water.

⚠ Warning

A crash can damage the safety belt system in the vehicle. A damaged safety belt system may not properly protect the person using it, resulting in serious injury or even death in a crash. To help make sure the safety belt systems are working properly after a crash, have them inspected and any necessary replacements made as soon as possible.

Three-Point Seat Belt

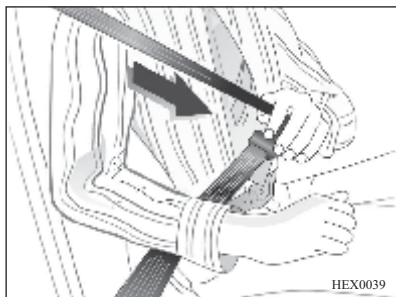

Pull the seat belt out of the retractor, guide it across the body without any twists, and then buckle the belt.

During driving, the lap belt can be tightened by pulling the shoulder section with force.

⚠ Warning

You could be seriously injured if your belt is buckled in the wrong place. Always buckle your belt into the buckle nearest to you.

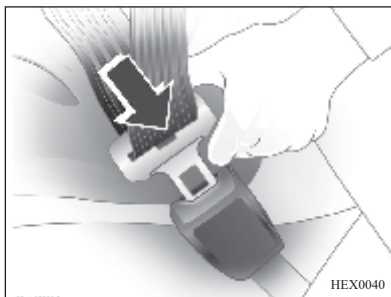

Loose or thick clothes will obstruct the position of the safety belt over the body. Do not place anything (e.g. a handbag or a mobile phone) between the safety belt and your body.

⚠ Warning

Never put the safety belt against hard objects or fragile items inside your pockets.

Seat Belt Release

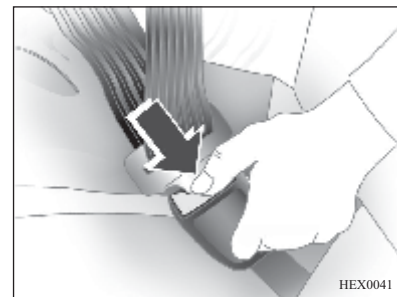

To release the safety belt, push the red button on the buckle.

The belt will retract automatically. Guide the safety belt as it retracts to prevent the latch plate from damaging interior surfaces or injuring occupants.

Caution

Folding a rear seat with the safety belts still fastened may cause damage to the seat or the safety belts. Always unbuckle the safety belts and return them to their normal stowed position before folding a rear seat.

Safety Belt Use During Pregnancy

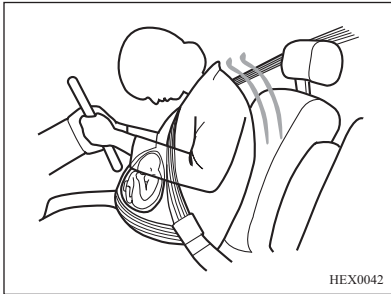

Safety belts work for everyone, including pregnant women. Like all occupants, they are more likely to be seriously injured if they do not wear safety belts.

A pregnant woman should wear a lap/shoulder belt, and the lap portion should be worn as low as possible, across the pelvis to prevent pressure on the abdomen.

The best way to protect the fetus is to protect the mother. When a safety belt is worn properly, it is more likely that the

fetus will not be hurt in a crash. For pregnant women, as for anyone, the key to make safety belts effective is wearing them properly.

Lap Belt

Center rear seat lap belt

Pull the buckle along the safety belt to adjust the length of the safety belt. To use, insert the front buckle into the locking ring which is placed to the right of your body and is marked "CENTER". Take the center buckle and bring the safety belt across your body. The safety belt should not be twisted. Insert the buckle into the locking ring at the other end. Press the red button to release the safety belt.

Belt Force Limiter

Fitted to the front seat belt, the belt force limiter can reduce the pressure on the body through the controlled release of the safety belt in case of collision accident.

Front Seat Belt Pretensioner*

The vehicle has safety belt pretensioners for the front outboard occupants.

Although the safety belt pretensioners cannot be seen, they are part of the safety belt assembly. They can help tighten the safety belts during a severe frontal crash and rear impact if the threshold conditions for pretensioner activation are met. Pretensioners are not designed to activate in a minor frontal crash.

Pretensioners are designed to activate in a moderate to severe frontal and rear crash. Pretensioners work only once.

Warning

Improper operation (such as removal or installation of the seat belt or the seat belt anchor) could trigger the seat belt pretensioner. It may lead to injury.

The seat belt pretensioner which has been activated should be replaced by CHEVROLET retailer. The seat belt pretensioner should be used only once.

CHILD RESTRAINTS*

Caution

Children who are small enough should always be restrained in infant or child restraints. Never hold a baby in your arms while riding in a vehicle. Never let a child stand or kneel on a seat or in the cargo area while the vehicle is moving.

Caution

An unsecured child restraint may be thrown out of the vehicle in a collision or sudden stop. You or passengers could be injured. Secure the child restraint properly even if a child is not using the restraint.

Caution

Child safety restraints are available in a wide range of sizes and configurations. Due to the shape and dimensions of your vehicle's interior and seats, not all child safety restraints will fit in your vehicle.

It is your responsibility to ensure that the child safety restraint you install fits properly and can be adequately attached to the vehicle with the child safety restraint anchors. A child safety restraint that is not the correct size for the vehicle or the child, or a child safety restraint that is improperly attached to your vehicle can lead to serious personal injury to the child and other passengers in the vehicle in the event of a collision.

Caution

A child restraint can become very hot if it is left in a closed vehicle in hot weather.

Make sure the child restraint is not too hot before placing a child there.

Be sure that if children are too small to be well restrained by the safety belt system, that they are secured in an appropriate child restraint.

The child restraint suitable for ISOFIX “universal” category can be used. The child restraint is not equipped with vehicle.

Child restraints can only be used in rear seating positions.

There are no anchor brackets available for front seating positions. Accident statistics show that children are safer if they are restrained in the rear seat.

Child Restraint Systems

When a child restraint system is being used, pay attention to the following usage and installation instructions supplied with the child restraint system.

Always comply with local or national regulations. In some countries, the use of child restraint systems is forbidden on certain seats.



Warning

NEVER use a rearward facing child restraint on a seat protected by an ACTIVE AIRBAG in front of it, DEATH or SERIOUS INJURY to the CHILD can occur.

Selecting The Right System

Children should travel facing rearwards in the vehicle as long as possible. This makes sure that the child's backbone, which is still very weak, is under less strain in the event of an accident.

Children under 12 years or under 150 cm tall should only travel in an appropriate child safety seat.

Never carry a child whilst traveling in the vehicle. The child will become too heavy to hold in the event of a collision.

When transporting children, use the child restraint systems suitable for the child's weight.

Ensure that the child restraint system to be installed is compatible with the vehicle type.

Warning

If the vehicle is equipped with a lap belt on the rear center seat, no child restraint system is allowed on this seat.

It is advised to mount the child restraint system only on one of the rear outer seats.

Ensure that the mounting location of the child restraint system within the vehicle is correct.

Allow children to enter and exit the vehicle only on the side facing away from the traffic.

When the child restraint system is not in use, secure the seat with a seat belt or remove it from the vehicle.

Note

Do not stick anything on the child restraint systems and do not cover them with any other materials.

A child restraint system which has been subjected to stress in an accident must be replaced.

Please ensure that infants and children are seated in the rear seats using child restraints.

Until the children can use seat belts, please select a child restraint suitable for its age and make sure the child wears it. Please see the instructions on the relevant products for child restraints.

Securing a Child Restraint By Using ISOFIX*

To secure a child restraint:

1. Locate the anchors where the seatback meets the back of the seat cushion.

The location of each lower anchor is identified by a circular mark on the lower edge of the rear seatback.

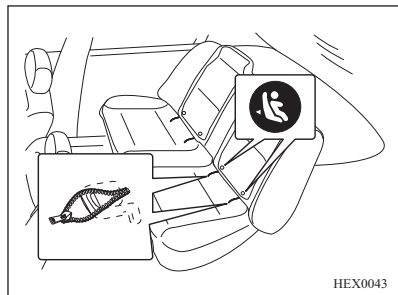

2. Clear all items off the seat. Move safety belts and safety belt buckles away from the lower anchors so they do not interfere with proper latching.
3. Place the child restraint on the seat.
4. Attach the anchor points on the

child restraint to the anchors in the vehicle. Follow the instructions that come with the restraint.

5. To attach the top strap to the top strap anchor -

Consult the manufacturer's instructions to determine when and how to tighten the top strap. The top strap anchor brackets are located at the joint between the left and right rear seatbacks on the rear compartment floor. Floor mat have a notch above itself, you can open the floor mat from the notch to use.

Warning

Children who are up against, or very close to, any airbag when it inflates can be seriously injured or killed. Never put a rear-facing child restraint in the front passenger seat. Secure a rear-facing child restraint in a rear seat. It is also better to secure a forward-facing child restraint in a rear seat.

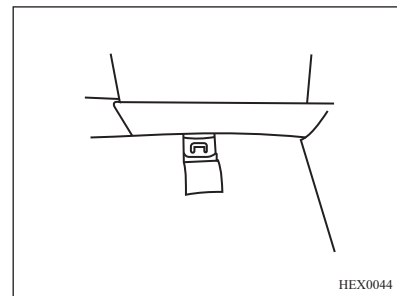

6. Push and pull the child restraint in different directions to make sure it is secure.
7. Make sure the child restraint is not too hot before placing a child there.

If you have been in a severe collision the anchoring system may have been damaged. Some parts may need to be repaired or replaced.

Have the anchoring system inspected after a collision.

Securing a Child Restraint Using Seat Belt *

This vehicle has the safety belt to secure the child restraint in rear outboard seating positions only. Be sure to follow the instructions that came with the child restraint. Secure the child in the child restraint when and as the instructions say.

1. Put the child restraint on the seat.
2. Pick up the latch plate, and run the lap and shoulder portions of the vehicle's safety belt through or around the restraint. The child restraint instructions will show you how.

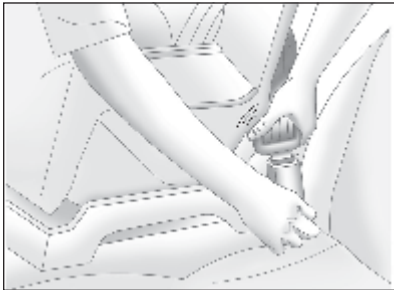

3. Push the latch plate into the buckle until it clicks.

Position the release button on the buckle so that the safety belt could be quickly unbuckled if necessary.

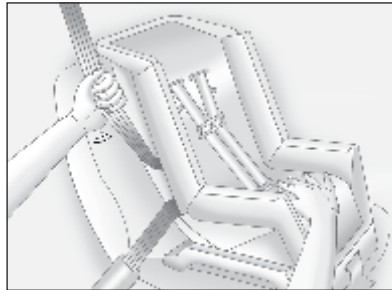

4. To tighten the belt, push down on the child restraint, pull the shoulder portion of the belt to tighten the lap portion of the belt and feed the shoulder belt back into the retractor. When installing a forward-facing child restraint, it may be helpful to use your knee to push down on the

child restraint as you tighten the belt.

If the child restraint system has a lock-off mechanism, use it to secure the vehicle safety belt.

5. If the child restraint has a top tether, follow the child restraint manufacturer's instructions regarding the use of the top tether.
6. Before placing a child in the child restraint, make sure it is securely held in place. To check, push and pull the child restraint in different directions to be sure it is secure.

To remove the child restraint, unbuckle the vehicle safety belt and let it return to the stowed position. If the top tether is attached to a top tether anchor, disconnect it.

AIRBAG SYSTEM*

Airbags are designed to supplement the protection provided by safety belts. Even though today's airbags are also designed to help reduce the risk of injury from the force of an inflating bag, all airbags must inflate in milliseconds. It will then deflate so quickly that people are usually unaware of their existence.

All of the airbags in the vehicle will have the word AIRBAG embossed on the trim or on an attached label near the deployment opening.

For frontal airbags, the word AIRBAG will appear on the center of the steering wheel for the driver and on the instrument panel for the outboard front passenger.

When the ignition switch is turned ON, the airbag warning light will illuminate briefly. This shows that the light bulb and airbag system are functioning properly.

See Warning Light for Airbag on page 60.

Warning

The airbag system may be triggered abruptly by improper operation.

Warning

Because airbags inflate with great force and faster than the blink of an eye, anyone who is up against, or very close to any airbag when it inflates can be seriously injured or killed. Do not sit unnecessarily close to any airbag, as you would be if sitting on the edge of the seat or leaning forward. Safety belts help keep you in position before and during a crash. Always wear a safety belt, even with airbags. The driver should sit as far back as possible while still maintaining control of the vehicle.

Warning

You can be severely injured or killed in a crash if you are not wearing your safety belt, even with airbags. Airbags are designed to work with safety belts, not replace them. Also, airbags are not designed to inflate in every crash. In some crashes safety belts are the only restraint. See *When Should an Airbag Inflate?* on page 44.

Wearing your safety belt during a crash helps reduce the chance of hitting things inside the vehicle or being ejected from it. Airbags are “supplemental restraints” to the safety belts. Everyone in the vehicle should wear a safety belt properly, whether or not there is an airbag for that person.

Important Note

Remember that rear-facing child seats must be installed on rear seats. Children should use rear-facing safety seats. Do not install these on front seats. If installed on front seats, deployment of the airbag may cause severe injury or even death.

Children Should Sit On Rear Seats

According to statistics on accidents, 12-year-old or younger children are safer when sitting on rear seats with proper protective devices than on front seats. Children should always sit on rear seats whenever possible.

The reason is not only that children may be injured by airbags, but research also suggests that children are safer in rear seats even if there are no front airbags.

Correct Seating Position

Adults or teenagers sitting on the driver seat or the passenger seat should also sit in a correct manner to ensure safe and effective function of airbags.

The best seating posture for adults and teenagers is as shown:

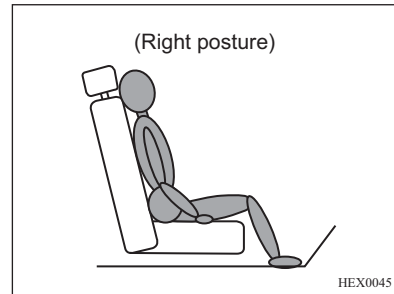

- **Always fasten safety belts.**

All passengers including the driver should always fasten safety belts so that the risk of injury during collisions can be minimized.

Airbags normally do not inflate on

a rear or side impact. In these kinds of collisions, passengers who do not wear safety belts will not be protected by protective devices, thus resulting in casualties.

Before collision, braking may cause passengers who are not wearing safety belts correctly to move forward, bringing their bodies close to or in contact with the airbag assembly. The deployment of the airbags may cause injuries or deaths.

- **Adjust your seatback to a comfortable and safe position.**

Keeping your seat away from the air bag assembly will not reduce the protective effectiveness of airbag. The farther you sit from airbag assembly, the lesser the chance of injury when the airbag inflates suddenly. But remember not to move the driver's seatback too far away to enable comfortable operation of the steering

wheel, pedals and other controls.

- **Set the seatback angled slightly back but do not lean your body forward.**

Slightly recline the seatback and lean your back against the seatback when sitting. Do not lean or otherwise move closer to the airbag assembly, i.e. the distance from the airbag should be minimum 25 cm. Do not bring any part of your body into contact with or close to the plastic decorative cover of airbag assembly (at the central part of the steering wheel or the instrument panel above the glovebox which is in front of the front passenger seat). Keep your head and body more than 25 to 30 cm away from the airbag. The farther away, the safer.

- **Do not put any articles, children or pets between yourself and the airbag.**

The airbag assemblies in your

vehicle are located at the steering wheel and in the dashboard above the glove box. Depending on vehicle models, your vehicle may not be equipped with the airbag in the dashboard above the glove box. If any object is placed on, above, or close to the plastic cover of airbag assembly, the object could be thrown onto your face and your upper body when the airbag is inflated, resulting in serious injury.

Children and pets must not sit on passenger's laps. Anything that may hurt the passenger when the airbag is being inflated should not be placed on his or her lap.

- Do not install any non-genuine accessories on the steering wheel or instrument panel since they may hinder the airbag from being inflated, interfere with operation of the system or hit the passenger and cause injuries.
- Never make any change to the

components of the airbag system. Improper operation may cause accidental inflation of the airbag and may injure the driver and front seat passenger.

- If the car has been driven into deep water, seek help from your CHEVROLET retailer.
- Dismantling of steering wheel or instrument panel can only be performed by your CHEVROLET retailer.
- The airbag is designed to be inflated only once, and once it has been inflated, it should be replaced by your CHEVROLET retailer.
- Do not stick or place anything on the steering wheel and the airbag cover. Use only a wet cloth to clean the surface of the airbag cover.
- Do not place anything on your lap or between your legs. Otherwise if the airbag inflates, the risk of injury or death will be much higher.

- If you sell the car, inform the new owner that the car is equipped with an airbag system and suggest that he/she also reads this Manual.
- There may be hazards when scrapping a car if the airbag has not been inflated. Contact your CHEVROLET retailer when your car needs scrapping.

Caution

If your car is severely damaged and the airbag is not inflated or your car is not severely damaged but the airbag is activated, this does not necessarily mean there is a fault with the airbag system.
Collision sensors detect the rate of change of speed in an axial direction rather than the extent of damage.

⚠ Warning

Children, infants, mothers-to-be, the elderly, and other sick or frail people, must not sit on a front seat with an airbag system.

In addition, a child seat must not be installed on the front seat as the inflated airbag may cause injury to the face or even death of the child when an accident occurs.

The airbag is not necessarily triggered each time a collision occurs. The airbag system may not be triggered in the following accidents.

- Minor accidents when the safety belts can provide sufficient protection;
- Rear impacts or collisions;
- Diagonal collisions with another vehicle with the impact at a front corner;

- Overturning or rollover of the car;
- Hitting a lamp post or a tree at a low speed without great force.

⚠ Warning

Children who are up against, or very close to, any airbag when it inflates can be seriously injured or killed. Airbags plus lap-shoulder belts offer protection for adults and older children, but not for young children and infants. Neither the vehicle's safety belt system nor its airbag system is designed for them. Young children and infants need the protection that a child restraint system can provide. Always secure children properly in the vehicle.

Front Airbag System*

The front airbag system includes an airbag in the steering wheel and another in the dashboard on the passenger side. Depending on vehicle models, your vehicle may not be equipped with the airbag in the dashboard on the passenger side.

These airbags can be identified by the marking AIRBAG.

Where Are the Airbags?



The driver frontal airbag is in the middle of the steering wheel.

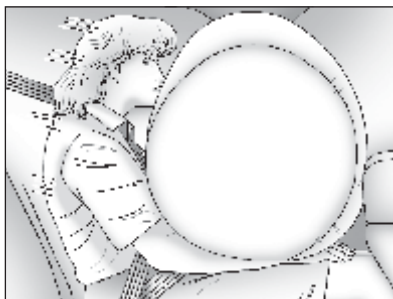

The outboard front passenger frontal airbag is in the instrument panel on the passenger side.

Warning

The best protection can be provided only when the seat is in a proper position.

No obstacles are allowed within the inflation area of airbag.

Wear the seat belt correctly so that the air bag can provide protection.

When Should an Airbag Inflate?

Frontal airbags are designed to inflate in moderate to severe frontal or near-frontal crashes to help reduce the potential for severe injuries mainly to the driver's or outboard front passenger's head and chest. However, they are only designed to inflate if the impact exceeds a predetermined deployment threshold. Deployment thresholds are used to predict how severe a crash is likely to be in time for the airbags to inflate and help restrain the occupants.

Whether the frontal airbags will or should deploy is not based on how fast your vehicle is traveling. It depends largely on what you hit, the direction of the impact, and how quickly your vehicle slows down.

Frontal airbags may inflate at different crash speeds. For example:

- If the vehicle hits a stationary object, the airbags could inflate at a different crash speed than if the vehicle hits a moving object.

- If the vehicle hits an object that deforms, the airbags could inflate at a different crash speed than if the vehicle hits an object that does not deform.
- If the vehicle hits a narrow object (like a pole), the airbags could inflate at a different crash speed than if the vehicle hits a wide object (like a wall).
- If the vehicle goes into an object at an angle, the airbags could inflate at a different crash speed than if the vehicle goes straight into the object.

Thresholds can also vary with specific vehicle design.

Frontal airbags are not intended to inflate during vehicle rollovers, rear impacts, or in many side impacts.

Always wear your safety belt, even with frontal airbags.

In any particular crash, no one can say whether an airbag should have inflated

simply because of the damage to a vehicle or because of what the repair costs were. For frontal airbags, inflation is determined by what the vehicle hits, the angle of the impact, and how quickly the vehicle slows down.

What Makes an Airbag Inflate?

In a deployment event, the sensing system sends an electrical signal triggering a release of gas from the inflator. Gas from the inflator fills the airbag causing the bag to break out of the cover and deploy. The inflator, the airbag, and related hardware are all part of the airbag module. Frontal airbag modules are located inside the steering wheel and instrument panel.

How Does an Airbag Restrain?

In moderate to severe frontal or near frontal collisions, even belted occupants can contact the steering wheel or the instrument panel. In moderate to severe side collisions, even belted occupants can contact the inside of the vehicle.

Airbags supplement the protection provided by safety belts. Frontal airbags distribute the force of the impact more evenly over the occupant's upper body, stopping the occupant more gradually.

But airbags would not help in many types of collisions, primarily because the occupant's motion is not towards those airbags. See *When Should an Airbag Inflate?* on page 44 for more information.

Airbags should never be regarded as anything more than a supplement to safety belts.

What Will You See After an Airbag Inflates?

⚠ Warning

When an airbag inflates, there may be dust in the air. This dust could cause breathing problems for people with a history of asthma or other breathing trouble. To avoid this, everyone in the vehicle should get out as soon as it is safe to do so. If you have breathing problems but cannot get out of the vehicle after an airbag inflates, then get fresh air by opening a window or a door. If you experience breathing problems following an airbag deployment, you should seek medical attention.

After the frontal airbags inflate, they quickly deflate, so quickly that some people may not even realize an airbag inflated. Some components of the airbag module may be hot for several minutes. For location of the airbags, see *Where Are the Airbags?* on page 44.

The parts of the airbag that come into contact with you may be warm, but not too hot to touch. There may be some smoke and dust coming from the vents in the deflated airbags. Airbag inflation does not prevent the driver from seeing out of the windshield or being able to steer the vehicle, nor does it prevent people from leaving the vehicle.

Replacing Airbag System Parts After a Crash

⚠ Warning

A crash can damage the airbag systems in the vehicle. A damaged airbag system may not work properly and may not protect you and your passenger(s) in a crash, resulting in serious injury or even death. To help make sure the airbag systems are working properly after a crash, have them inspected and any necessary replacements made as soon as possible.

If an airbag inflates, you will need to replace airbag system parts. See your CHEVROLET retailer for service.

Airbag System Check

The airbag system does not need regularly scheduled maintenance or replacement. Make sure the airbag warning light is working. See *Warning Light for Airbag* on page 60.

Caution

If an airbag covering is damaged, opened, or broken, the airbag may not work properly. Do not open or break the airbag coverings. If there are any opened or broken airbag covers, have the airbag covering and/or airbag module replaced. For the location of the airbags, see *Where Are the Airbags?* on page 44. See your CHEVROLET retailer for service.

STORAGE

Storage Compartment	47
Storage Compartment on Instrument Panel	47
Glove Box	47
Seatback Pockets*	48
Cup Holders	48
Seatback Hooks	49
Roof Paneling	49
Assist Grip	49
Loading Information	50

STORAGE COMPARTMENT

Storage Compartment on Instrument Panel

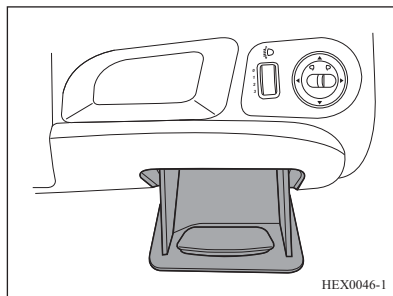

Instrument panel storage compartment is located on right side of the instrument panel.

Pull the handle to open the storage compartment.

To close the compartment, firmly push the door.

Glove Box

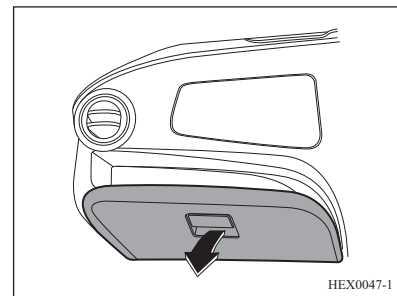

Glove box can be opened by pulling the handle.

Close the glove box with a firm push.

Warning

Keep the door of glove box closed while driving to reduce the risk of injury in the event of an accident or a sudden stop.

Seatback Pockets*

The seatback pockets are located on the backrest of the two front seat backrests.

CUP HOLDERS

▲ Warning

Do not place uncovered cups of hot liquid in the cup holder while the vehicle is in motion. If the hot liquid spills, you burn yourself. Such a burn to the driver could lead to loss of control of the vehicle.

To reduce the risk of personal injury in the event of sudden stop or collision, do not place uncovered or unsecured bottles, glasses, cans, etc., in the cup holder while the vehicle is in motion.

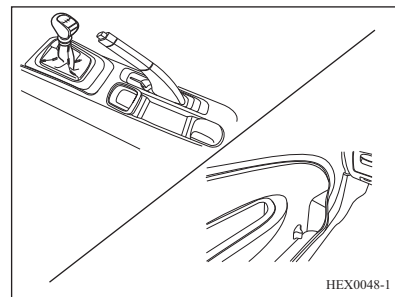

The front cup holders are located in the storage recesses on the inner panels of the front doors.

The rear cup holders are located in the rear part of the center console.

SEATBACK HOOKS

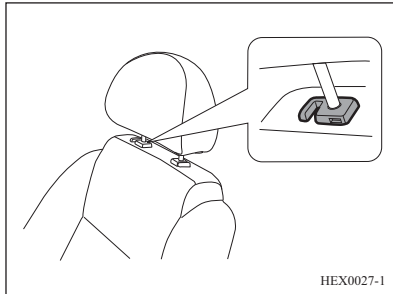

There is a hook at the joint of the backrest and head restraint for each front seat. The hooks can be used to hold shopping bags or other objects as desired.

ROOF PANELING

Assist Grip

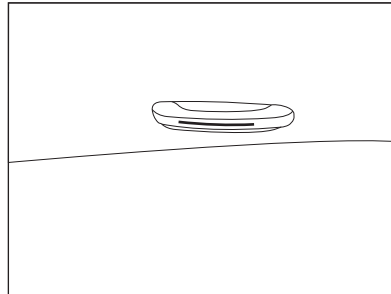

Your vehicle has assist grips above the front seat passenger's door and the rear doors.

Passengers can use the grips for assistance in entering / exiting the vehicle, or for hand-holds during the vehicle in motion.

Caution

Hanging items on your vehicle's assist grips can obstruct the driver's view.

Do not hang anything on the assist grips, unless they are equipped with a coat hook.

Obstructing the driver's view can lead to an accident resulting in personal injuries and damage to your vehicle or other property.

LOADING INFORMATION

 **Warning**

Do not place lighters, propane bottles or other flammable/explosive materials in the vehicle. These materials could catch fire and/or explode when exposed to high temperatures for a long time.

- Heavy objects in the rear compartment should be placed against the seatback. Ensure the seatback is securely fixed. If objects are stacked, heavy objects should be put at the bottom.
- Any loose objects in the rear compartment should be fixed to avoid sliding.
- Luggage should not protrude above the upper edge of the seatback.
- Do not place any objects on the instrument panel.
- Luggage must not impede the operation of the pedals, parking brake or gear shift. The driver's movements must not be restricted.

Do not put any loose objects in the vehicle.

- Do not drive with the tailgate open.
- Driving with a roof load increases the sensitivity of the vehicle to cross-winds and has a detrimental effect on vehicle handling due to the vehicle's higher center of gravity. Distribute the load evenly and secure it properly with retaining straps. Adjust the tire pressure and vehicle speed according to the load conditions. Check and retighten the straps frequently. Do not exceed the maximum vehicle capacity when loading the vehicle.

INSTRUMENTS AND CONTROLS

Controls 51

- Horn 51
- Steering Wheel Adjustment..... 52
- Windshield Washer/
Wiper System52
- Tailgate Window Wiper/ Washer
System* 54
- Accessory Power Outlet 55

Warning Lights, Gauges and
Indicators..... 55

- Speedometer 55
- Odometer/Trip Odometer 56
- Tachometer 56
- Fuel Gauge 57
- Control Indicator Lights 57
- Instrument Cluster 58
- Warning Light for Low
Fuel Level 59
- ABS Warning Light* 59
- Warning Light for Airbag* 60

- Warning Light for Brake
System 60
- Warning Light for Battery
Charging System 62
- Warning Light for Engine Oil
Pressure 63
- Malfunction Indicator Light 63
- Door Ajar Light 64
- Engine Coolant Temperature
Warning Light 65
- Front Fog Light Indicator* 65
- Driver Seat Belt Warning
Light* 65
- Turn Signal/Hazard Warning
Flashers 66
- Headlight High Beam Indicator
Light 66
- Water in Fuel Indicator Light67
- Glow Plug Indicator Light67
- Other Warning Tone Prompts*67

CONTROLS

Horn

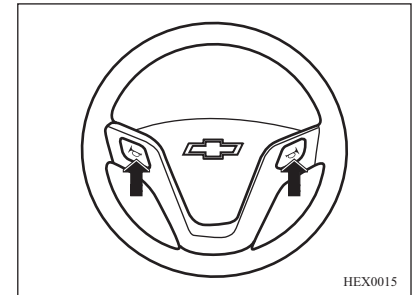

Press the  switch on the steering wheel pad to sound the horn.

Steering Wheel Adjustment

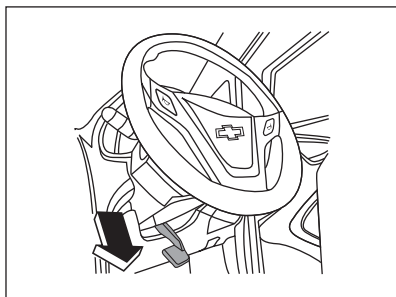

For vehicles with a tilt wheel:

1. Hold the steering wheel and pull the lever down.
2. Move the steering wheel up or down.
3. Pull the lever up to lock the steering wheel in place.

Do not adjust steering wheel unless vehicle is stationary.

Caution

If strong impact delivers to steering column axle direction when the steering wheel is adjusted or the lever is locked, it may cause damage to the parts related to steering wheel.

Windshield Washer/ Wiper System

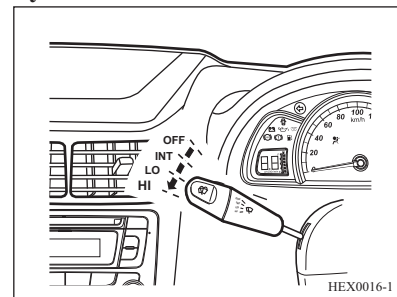

To use the windshield wipers, first turn ON the ignition switch, then push the windshield washer/wiper lever downwards.

The windshield wipers have the following 4 working positions:

OFF : System off

INT : Intermittent operation

LO : Wiping continuously at low speed

HI : Wiping continuously at high speed

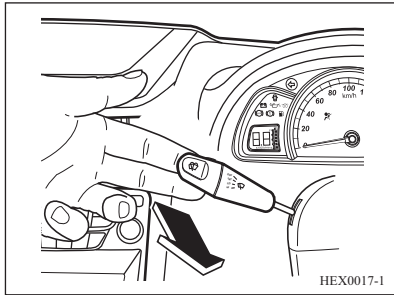

To spray washer-fluid onto the windshield:

- The ignition switch is in the ON position.
- Pull the windshield washer/wiper lever towards you.

If you pull the lever for less than 0.6 second, the following will occur:

- The washers will spray washer fluid onto windshield. (Windshield wipers will not operate.)

If you pull the lever for more than 0.6 second:

- The washers will spray washer fluid onto windshield.
- Windshield wipers operate 3 cycles or until you release the lever.

Caution

Less than clear vision for the driver can lead to an accident resulting in personal injury and damage to your vehicle or other property.

Do not operate the windshield wipers when the windshield is dry or obstructed, as with snow or ice. Using the wipers on an obstructed windshield can damage the wiper blades, wiper motor, and glass.

Check that wiper blades are not frozen to windshield before operating in cold weather. Wiper operation while blade is frozen can damage wiper motor.

Caution

Do not operate windshield washers for more than 10 seconds continuously or when the washer fluid reservoir is empty.

Otherwise the washer motor may overheat, leading to expensive repair costs.

Misting function

To operate the windshield wipers once in case of light rain or mist, lightly move the windshield wiper/washer lever towards the INT position and release it.

The lever will return automatically to its normal position when released. The wipers will operate through one cycle.

Tailgate Window Wiper/ Washer System*

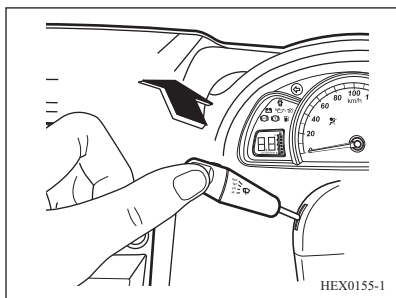

To use the tailgate window wiper and washer, push the lever towards the instrument.

The wiper works continuously at low speed at the first position.

To spray washer fluid, push the lever to the second position.

Caution

The loss of visibility will lead to accidents, which may result in personal injury, damage to the vehicle or other property.

Do not use the tailgate window wiper when the tailgate window is dry or frozen with ice and snow.

When the wiper is used with obstacles on the window glass, the wiper blades, wiper motor and window may be damaged.

In freezing weather conditions, first check whether the blade is frozen onto the window before using the wiper. The wiper motor may be damaged when the wiper is used with its blade frozen.

Caution

Do not operate the tailgate window washer for more than 10 seconds continuously, or when the washer fluid reservoir is empty. Otherwise the washer motor may overheat, leading to expensive repair costs.

Accessory Power Outlet

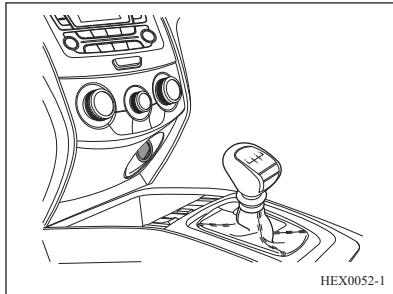

Only when the ignition switch is in ACC / ACCESSORY or ON position, the accessory power outlet can be used.

The 12V accessory power outlet can be used to plug in electrical equipment, such as cell phone or an MP3 player.

Certain accessory power plugs may not be compatible with the accessory power outlet and could overload vehicle or adapter fuses. If a problem is experienced, see your CHEVROLET retailer.

When adding electrical equipment, be sure to follow the proper installation instructions included with the equipment.

Caution

Do not connect any current delivering accessories, e.g. electrical charging devices or batteries.

Do not damage the sockets by using unsuitable plugs.

⚠ Warning

If you leave any inflammable or explosive substances inside the vehicle, such as in summer, a disposable lighter inside the vehicle, it can blow up due to increased temperature in the passenger and rear compartments and cause a fire.

Make sure there is no inflammable and explosive substances left in the vehicle.

WARNING LIGHTS, GAUGES AND INDICATORS

Speedometer

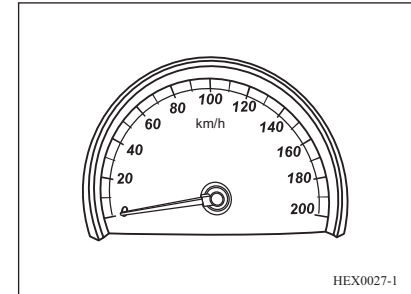

The speedometer shows the vehicle's speed in kilometer per hour (km/h).

Note

In a speed limit zone, please keep to the speed limit.

Odometer/Trip Odometer

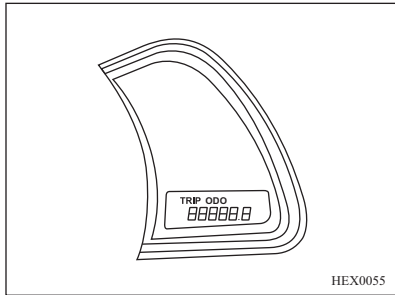

HEX0055

The odometer/trip odometer is located in the small display screen on the right of the instrument cluster.

The odometer shows the distance in kilometers that the vehicle has driven so far. The trip odometer shows the distance in kilometers that the vehicle has been driven since the last reset. To reset the trip odometer, press and hold the mode selection button under the speedometer until it is reset to zero. Press the mode selection button briefly to switch between odometer and trip odometer.

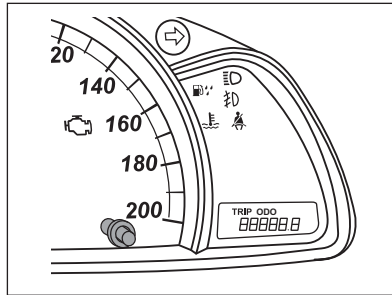

Caution

It is prohibited by law to operate the odometer illegally.

Tachometer

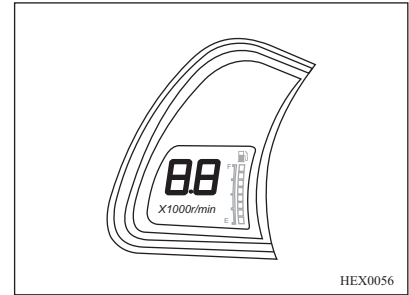

HEX0056

The digital tachometer displays the engine speed in revolutions per minute (rpm). Drive in a low engine speed range for each gear as much as possible.

Fuel Gauge

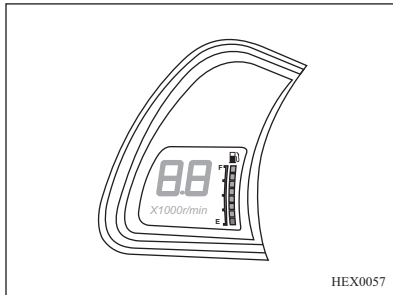

Displays the fuel level in the fuel tank. If the fuel level in the fuel tank is too low, the control indicator light will illuminate. Please refuel immediately.

Never empty the fuel tank and run the tank dry!

Because of the fuel remaining in the tank, the top-up quantity may be less than the specified tank capacity.

Movement of the fuel within the fuel tank causes the fuel gauge display to change when you brake, accelerate or turn.

Danger

Before refueling, switch off engine and any external heaters with combustion chambers. Switch off any mobile phone.

Vaporised fuel can be ignited by electromagnetic waves or electric current of mobile phone.

Fuel is flammable and explosive. No smoking. No naked flames or sparks. Follow the operating and safety instructions of the filling station when refueling.

Remove static electricity on your hands by touching something able to release static electricity when touching or opening fuel cap or refueling nozzle.

Don't do any action making static electricity like getting on and off vehicle when refueling. Vaporised fuel can be ignited by static electricity.

Control Indicator Lights

The control indicator lights described in this Manual may not appear on all models. This instruction applies to all instrument types. When the ignition switch is turned ON, as a function test, most of the control indicator lights will be illuminated for a short period.

The color of a control indicator light means:

Red = Danger, important reminder
 Yellow = Warning, information, fault
 Green = Activation confirmed
 Blue = Activation confirmed

Instrument Cluster

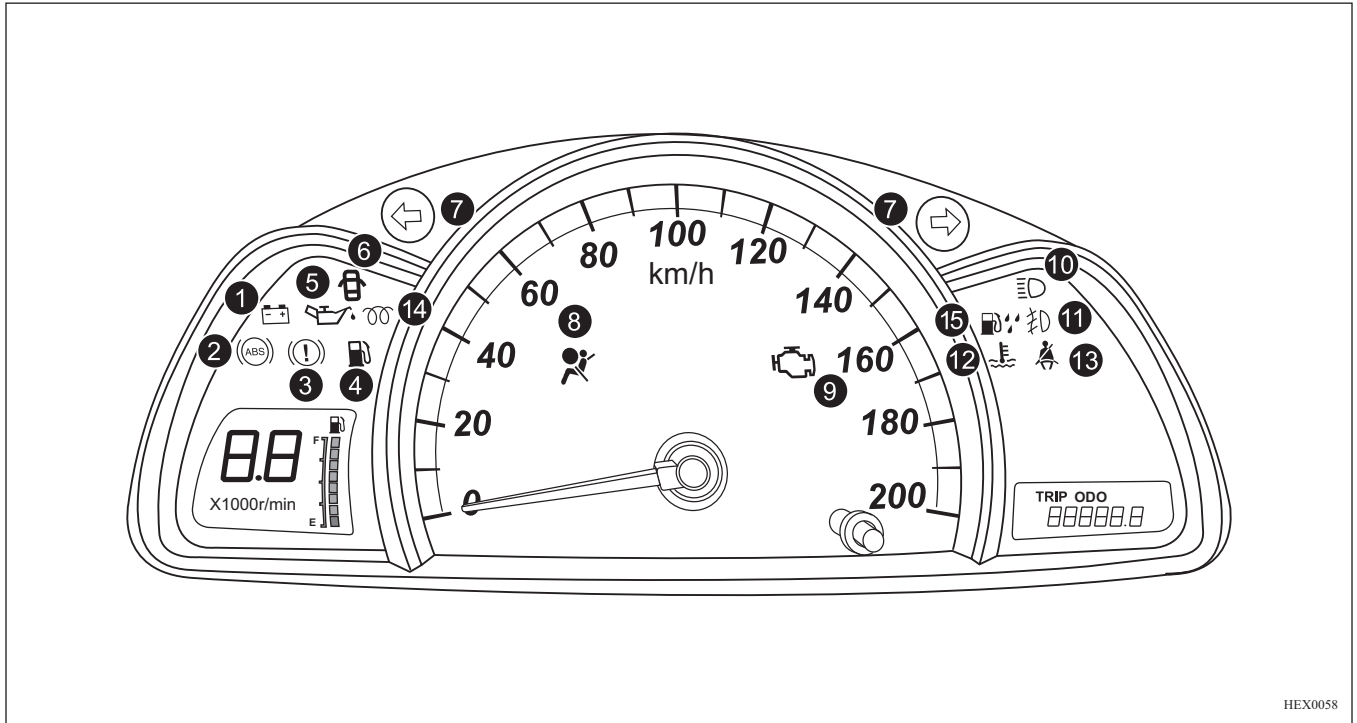

1. Warning light for battery charging system
2. ABS warning light*
3. Warning light for brake system
4. Warning light for low fuel level
5. Warning light for engine oil pressure
6. Door ajar light
7. Turn signal/hazard warning flashers
8. Warning light for airbag*
9. Malfunction indicator light
10. Headlight high beam indicator light
11. Front fog light indicator light*
12. Engine coolant temperature warning light
13. Driver seat belt warning light*
14. Glow plug indicator light
15. Water in fuel indicator light

Warning Light for Low Fuel Level

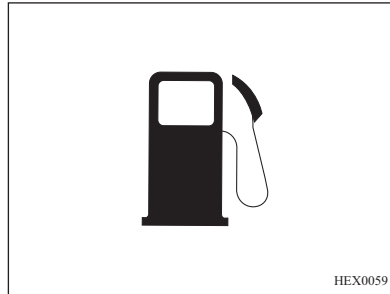

This light comes on when the fuel tank is low on fuel. When fuel is added, the light should go off. If it does not, have the vehicle serviced.

Caution

Do not let your vehicle run out of fuel. This can damage the catalytic converter.

When this warning light illuminates, please fill the fuel tank as soon as possible.

See Fuel on page 95. See Diesel Fuel System Bleeding on page 98.

ABS Warning Light*

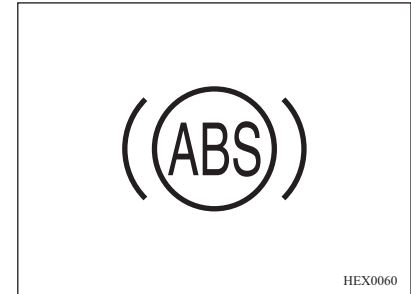

If the vehicle is equipped with ABS, when the ignition switch is turned ON, the ABS warning light will illuminate for a moment. This shows that the system is doing a self-test and the indicator light bulb is working correctly. This warning light should go off after a few seconds.

When the following situations occur with regard to the ABS warning light, please consult your CHEVROLET retailer.

- The light does not illuminate when the ignition switch is turned ON.

- The light does not go off.
- The light illuminates while driving.

Caution

When the ABS warning light illuminates, it indicates that your brakes may not work properly.

If the brakes are not kept in good working condition, this may lead to collisions resulting in personal injury and damage to your vehicle or other property.

If the ABS warning light illuminates while driving, it indicates that your ABS system may be faulty. Although your vehicle may be driven normally without the ABS function, you should consult your CHEVROLET retailer as soon as possible for a necessary repair.

Warning Light for Airbag*



When the ignition switch is turned ON, the airbag warning light will illuminate briefly. This shows that the indicator light bulb and airbag systems are functioning properly.

Caution

If the airbag warning light flashes or stays on when driving, it indicates a fault in the airbag system. The airbag system will be disabled and cannot be triggered when an accident occurs. Consult your CHEVROLET retailer for necessary repair.

If an accident occurs with the vehicle which has a faulty airbag system, it may result in personal injury or even fatalities.

When the airbag system has a fault, the warning light will indicate this as follows:

- The light does not illuminate when the ignition switch is turned ON.
- The light does not go off after illuminating briefly.
- The light flashes while driving.
- The light does not go off during driving.

Warning Light for Brake System

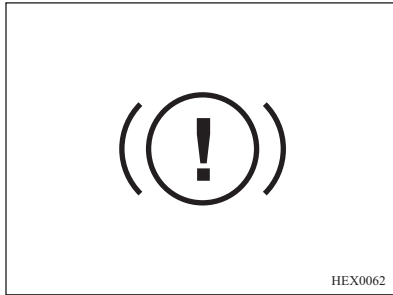

When the ignition switch is turned ON and before the engine is started, the brake system warning light will illuminate.

This indicates that the indicator light works properly and the light will go off when the engine is started.

When the parking brake is engaged, the brake system warning light will be illuminated as well. When the parking brake is released, then the indicator light will go off. Make sure that the parking brake is fully released before you drive the vehicle away.

Caution

Do not drive the vehicle while the brake system warning light is still illuminated.

This phenomenon may indicate that your brakes are not working properly.

If you drive while the brake system has a fault, this may lead to collisions resulting in personal injury and damage to your vehicle or other property.

If the parking brake is fully released and the brake system warning light still illuminates, it indicates that the brake fluid level in its fluid reservoir is too low.

To rectify this, please perform the following steps:

1. Carefully drive the vehicle away from the carriageway and stop.
2. Check the brake fluid level.

3. Add the recommended brake fluid to the MAX (maximum) mark. See Adding Brake/Clutch Fluid on page 110.
4. In the following cases, drive the car at a safe speed to your CHEVROLET retailer to have the brakes checked and determine whether:
 - The brakes work properly.
 - According to your own judgment, the vehicle's brakes are safe.
5. In the following cases, tow the car to your CHEVROLET retailer to have brakes checked and repaired:
 - Leak found in the brake system.
 - The warning light for the brake system illuminates continuously.
 - The brakes work abnormally.

Caution

Do not drive the vehicle if the brake system warning light does not illuminate, when the parking brake is engaged and the ignition switch is turned ON.

Ensure that the warning light is working correctly. If the light does not illuminate when the parking brake is engaged and the ignition switch is turned ON, even if the warning light is working correctly, consult your CHEVROLET retailer to have the vehicle's brake system checked.

These situations indicate that your vehicle's brake system may have a fault.

If the vehicle's brakes are not kept in good working condition, this may lead to collisions resulting in personal injury and damage to your vehicle or other property.

Warning Light for Battery Charging System

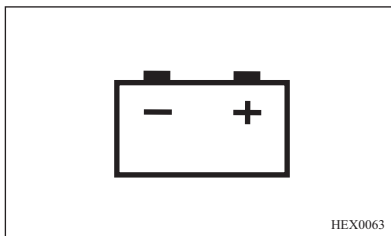

The charging system light comes on briefly when the ignition is turned ON, but the engine is not running, as a check to show the light is working. The light turns off when the engine is started. If it does not, have the vehicle serviced by your CHEVROLET retailer. If the light stays on, or comes on while driving, there could be a problem with the electrical charging system. Have it checked by your CHEVROLET retailer. Driving while this light is on could drain the battery.

If a short distance must be driven with the light on, be sure to turn off all accessories, such as the audio system and air conditioner.

Caution

The battery charging system warning light indicates that the battery charging system may have a fault. Do not drive while the battery charging system warning light is still lit.

Driving with a faulty battery charging system will damage the vehicle.

If the battery charging system warning light illuminates while driving:

1. Carefully drive the vehicle away from the carriageway.
2. Stop the vehicle.
3. Make sure that the drive belt is not loose or broken.
4. If the drive belt works properly, but the battery charging system warning light still illuminates continuously, it indicates that the battery charging system may be faulty.

Please consult your CHEVROLET retailer as soon as possible for repair.

Warning Light for Engine Oil Pressure



After the ignition switch is turned ON and before the engine is started, the warning light will illuminate. This shows that the indicator light bulb is working correctly.

When the engine is started, this warning light will go off.

If the engine oil pressure warning light illuminates while driving, it indicates that the engine oil pressure may have dropped to a dangerous level. Immediately stop the engine and check the oil level.

Caution

Lack of proper engine oil maintenance can damage the engine. Driving with the engine oil low can also damage the engine. The repairs would not be covered by the vehicle warranty. Check the oil level as soon as possible. Add oil if required, but if the oil level is within the operating range and the oil pressure is still low, have the vehicle serviced. Always follow the maintenance schedule for changing engine oil.

If the oil level is too low, add specified engine oil to a suitable level.

If the level is OK, consult your CHEVROLET retailer to have the engine lubrication system checked.

Malfunction Indicator Light

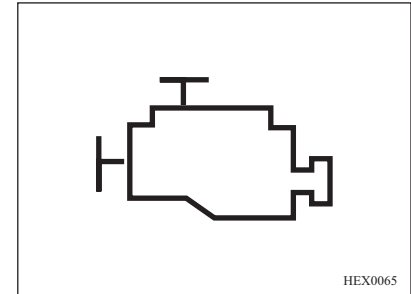

After the ignition switch is turned ON and before the engine is started, the indicator light will illuminate.

This shows that the indicator light bulb is working correctly.

When the engine is started, this warning light will go off.

Caution

Malfunction indicator light indicates that your vehicle has some fault that requires your attention. Driving while the Malfunction Indicator Light is on may damage the emission control system, affecting fuel economy and the vehicle's driveability.

Consult your CHEVROLET retailer as soon as possible for repair .

If the emission-related components or relevant subsystems have a fault, the Malfunction Indicator Light (MIL) will illuminate.

As long as the electronic control module (ECM) detects a fault, the Malfunction Indicator Light will illuminate continuously. If a serious misfire is detected, the Malfunction Indicator Light will flash continuously.

A serious misfire may damage the catalytic converter.

The electronic systems on the vehicle

will switch to an emergency operation program so that you can continue to drive the vehicle.

However, at this time you should drive to your CHEVROLET retailer as soon as possible.

If the MIL illuminates for a while then extinguishes itself, it is normal. It does not mean that the system has a fault.

Caution

Modifications made to the engine, transmission, exhaust, intake, or fuel system of the vehicle or the replacement of the original tires with other than those of the same Tire Performance Criteria (TPC) can affect the vehicle's emission controls and can cause this light to come on. Modifications to these systems could lead to costly repairs not covered by the vehicle warranty. This could also result in a failure to pass a required Emission Inspection/Maintenance test.

Door Ajar Light

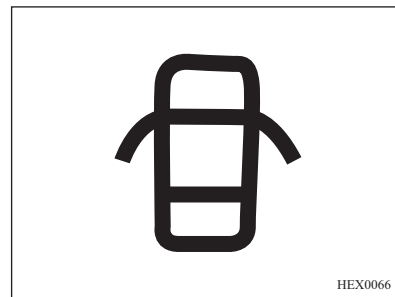

This light comes on when a door is open or not securely latched. Before driving check that all doors are properly closed.

Engine Coolant Temperature Warning Light

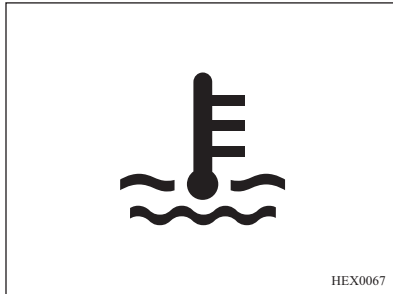

The engine coolant temperature warning light comes on briefly when the ignition is turned ON. This shows that the system is doing a self-test and the indicator light bulb is working correctly. If the system is working normally the indicator light then goes off.

If it does not, have the vehicle serviced by your CHEVROLET retailer.

This light indicates that the engine coolant has overheated. If the light comes on and stays on while driving, the vehicle may have a problem with cooling system. Stop the vehicle and turn off the engine to avoid damage to the engine.

Front Fog Light Indicator*

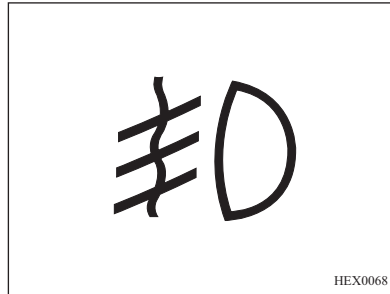

When the front fog lights are on, the indicator light illuminates.

See Front Fog Lights on page 71.

Driver Seat Belt Warning Light*



When the ignition switch is ON, the safety belt warning light will illuminate briefly. This means that the system is carrying out a self-test.

Thereafter, unless the driver has fastened the safety belt, the following will take place:

- Seatbelt warning light illuminates.
- Seatbelt warning buzzer will sound for about 6 seconds.
- If the vehicle speed exceeds 20 km/h, this light will stay on, and at the same time the warning buzzer will continue to sound for a period of time.

Turn Signal/Hazard Warning Flashers

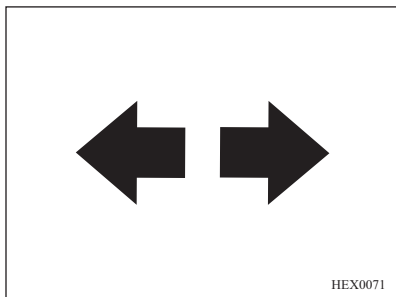

Turn signal/hazard warning flashers are used to confirm that the vehicle's external turn signal lights or hazard warning flashers are all working correctly.

If the green arrow does not flash when you activate the turn signal or press the hazard warning switch, then you should check the fuses and light bulbs, and replace them if necessary.

Caution

These indicators are essential for safe driving.

If the bulb in the turn signal light or hazard warning flasher is blown, it must be replaced immediately.

If these indicators are not kept in good working condition, this may lead to accidents resulting in personal injury and damage to your vehicle or other property.

Caution

If the flashing time is shorter than normal, it indicates that the turn signal light bulbs have blown and need to be replaced.

Headlight High Beam Indicator Light

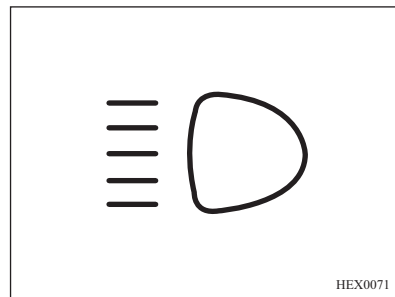

The high-beam indicator comes on when the high-beam headlamps are in use and during headlamp flash.

Water in Fuel Indicator Light



Illuminates, when the water level, in the water separator (separated from the diesel fuel) reaches to the maximum.

If the light comes on and remains on with the engine running, it indicates the need for draining of the water separator. Please visit the nearest CHEVROLET retailer for the water draining.

Caution

Engine high pressure fuel system will get damaged severely, if water from the water separator is not drained on time.

If water separator requires frequent draining, have the fuel tank drained at your CHEVROLET retailer.

Glow Plug Indicator Light

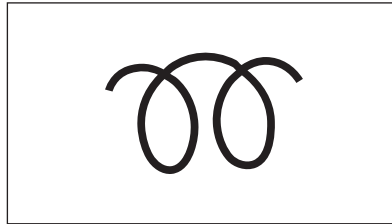

Illuminates when the ignition is ON and stays on for a short time or may go off right away. The waiting time will vary according to the engine coolant temperature.

When the glow plugs are sufficiently heated for cold starting, the light will go out. Then the engine should be started.

Glow plug indicator light blinks continuously to indicate any non emission faults (including glow plug system faults) and immobilizer related problems. See your CHEVROLET retailer for service.

Other Warning Tone Prompts*

In the following circumstances the vehicle will give an alarm tone to prompt the driver:

- After the vehicle's engine has been shut off, if the key is not removed from the ignition switch before opening any door;
- After the vehicle's engine has been shut off, if the headlamps are not switched off before opening any door;
- The vehicle speed exceeds 120 km/h.

Depending on the model, some vehicles may not have some or all of the above alarm tone prompt functions.

LIGHTING

Exterior Lighting 69

 Headlight Switch 69

 High Beam 70

 Headlamp Flash 70

 Misted Lamp Covers70

 Hazard Warning Flashers 71

 Turn and Lane Change Signal ... 71

 Front Fog Lights* 71

 Reverse Lights 71

 Headlamp Range Adjustment..... 72

Interior Lighting 72

 Reading Light 72

 Rear Compartment Light*72

EXTERIOR LIGHTING

Headlight Switch

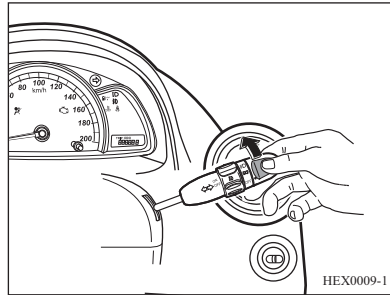

When the ignition switch is turned to LOCK or ACC/ ACCESSORY position, the headlamps will be turned off automatically. Only parking lights will be on, unless turned off using headlight switch.

To turn the headlamps, tail lamps or parking lights on or off, turn the end of the combination switch lever.

The headlight switch has three positions which activate different lighting functions:

OFF = Turn all lights off.

☞ = Instrument panel lights, parking lights and license-plate lights illuminate.

☛ = Low beam headlamps and all the above lights illuminate.

High Beam

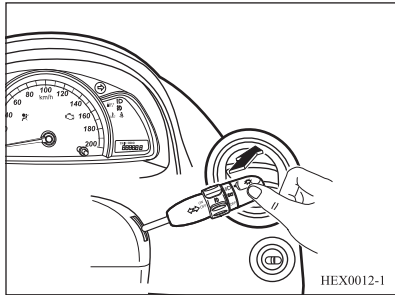

To turn on high beam headlights:

- Ensure that the headlamps are in low beam state.
- Push the combination switch lever towards the dashboard.

When the headlamp high beam is turned on, the headlamp high beam indicator light illuminates. To switch the headlamp from high beam to low beam, pull the combination switch lever back towards you to resume the normal position.

Warning

Always switch the high-beam headlamps to low-beam when you approach on coming vehicles or when other vehicles are ahead.

High-beam headlamps can temporarily blind other drivers, which could result in a collision.

Headlamp Flash

To make the headlamps high beam flash, pull the combination switch lever towards you and release. When you release it, the lever will return to the normal position.

If you pull the combination switch lever towards you and hold, the headlamp high beam will stay on.

Headlamp flash will work irrespective of light switch position.

Misted Lamp Covers

The inside of the light housing may mist up briefly in poor, wet and cold weather conditions, in heavy rain or after washing. The mist disappears quickly by itself. To help, switch on the headlights.

Hazard Warning Flashers

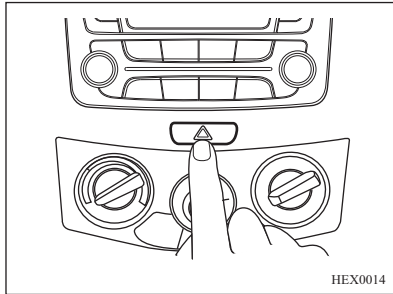

Press the  switch to turn on or turn off the hazard warning flashers.

Turn and Lane Change Signal

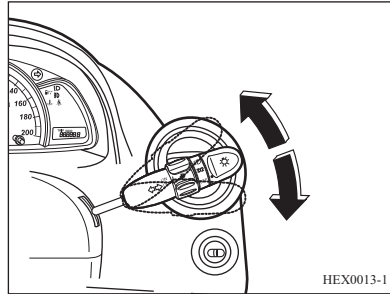

Lever up = Left indicator

Lever down = Right indicator

After turning, the turn signals will automatically reset and the lever will return to the normal position.

When you change driving lane, move the lever half way to the change direction and hold. When you release it, the lever will return to the normal position.

Front Fog Lights*

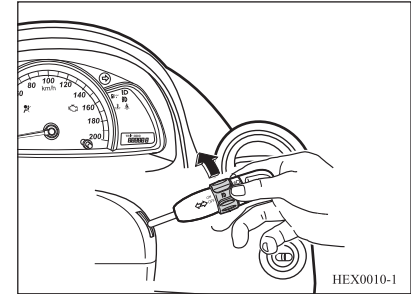

While the headlights are on parking light or low beam position, turn the ring in the middle of the combination switch lever to ON to turn on the front fog lights. Turn the ring to OFF position to turn off the front fog lights.

Reverse Lights

The reverse lights will illuminate when the ignition switch is ON and reverse gear is engaged.

Headlamp Range Adjustment

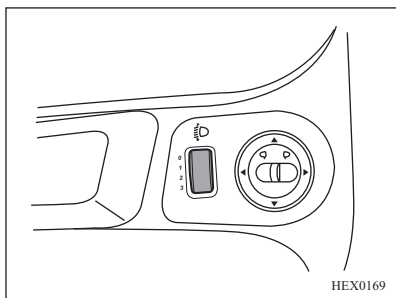

The headlamp range adjustment knob is located at the right of instrument panel.

To adapt headlamp range to the vehicle load to prevent dazzling: turn knob to required position:

- 0 = Driver's seat occupied.
- 0 = Front seats occupied.
- 1 = All seats occupied.
- 2 = All seats occupied and load in the luggage compartment.
- 3 = Driver's seat occupied and load in the luggage compartment.

INTERIOR LIGHTING

Reading Light

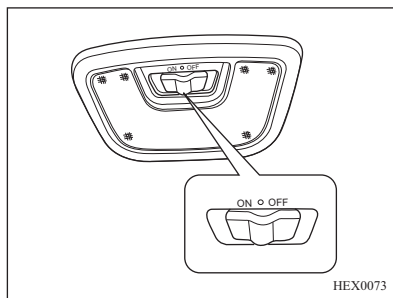

The reading light have three working positions:

ON : The light illuminates until you manually turn them off.

CENTER : The light illuminates when the door is opened, and is extinguished when the door is closed.

OFF : Even if the door is opened, the light does not illuminate.

Warning

Avoid using the courtesy light while driving in the dark.

A lit passenger compartment reduces visibility in the dark, and could cause a collision.

Rear Compartment Light*

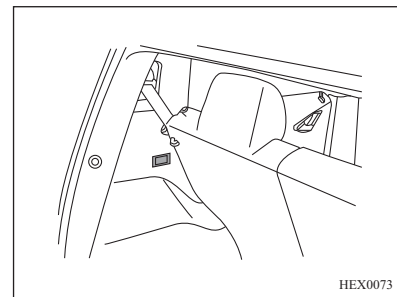

Rear compartment light comes on, when tailgate is open and goes off when tailgate is closed.

CLIMATE CONTROL SYSTEM

Air Vents	74
Control Panel	75
Temperature Control Selector	76
Fan Control Selector	76
Air Distribution Mode Selector...	76
Recirculation Mode Button	78
Air Conditioning System	79
Air Conditioning Button	80
Cool Air	80
Warm Air	81
Ventilation	81
Rear Window Defroster Button*	82
Defrosting and Demisting	83
Maintenance	84
Air Intake	84
A/C Mesh Filter.....	84
Air Conditioning Regular Operation	84

AIR VENTS

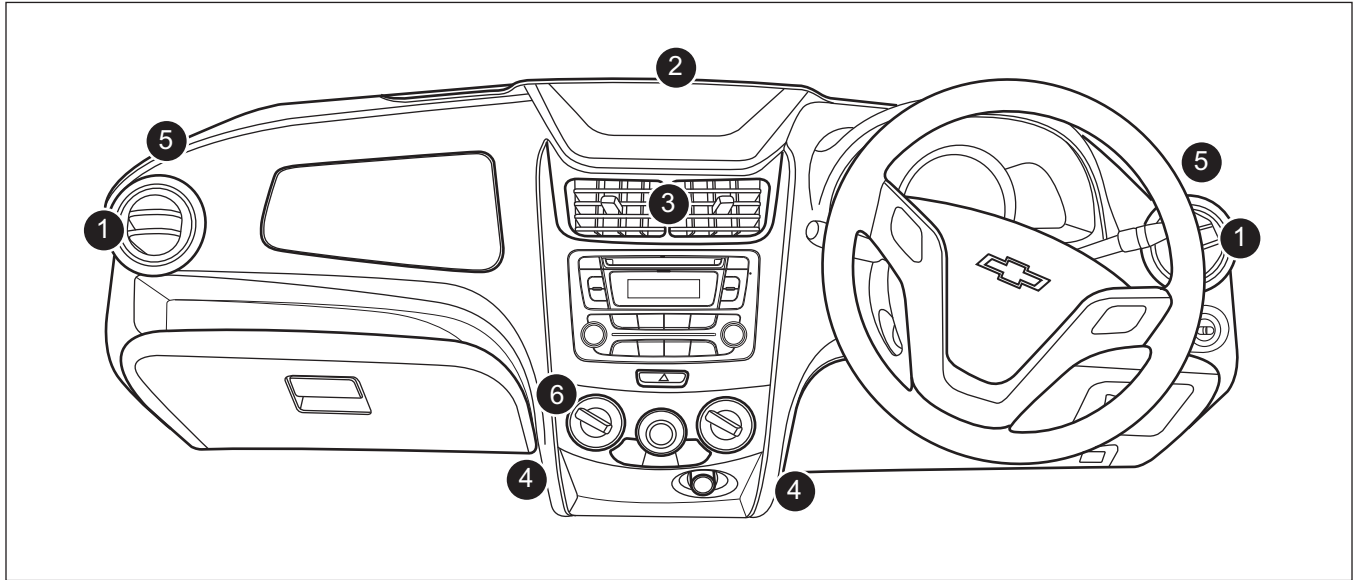

1. Side air vent

2. Windshield defroster vent

3. Center air vents

4. Floor vent

5. Front side window defroster vent

6. A/C Control panel

Side air vent

You can direct airflow to the front passenger area or to the side windows through the two adjustable side vents.

Windshield defroster vent

The windshield defroster vents direct airflow to the windshield.

Center air vent

You can direct airflow to the front passenger area through the two adjustable center vents.

Floor vent

Floor vents direct airflow to the front footwell.

Front window defroster vents

The front window defroster vents direct airflow to the side windows, especially to the area near the exterior rear view mirrors.

⚠ Warning

Do not attach any objects to the slats of the air vents. Risk of damage and injury in case of an accident.

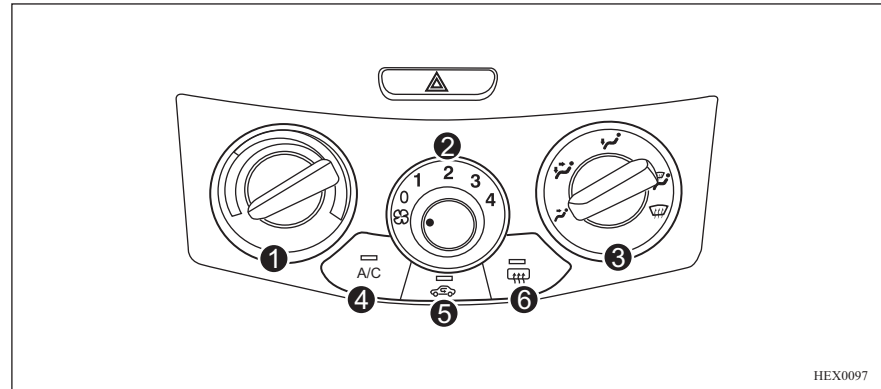
CONTROL PANEL

- | | |
|-----------------------------------|----------------------------------|
| 1. Temperature control selector | 4. Air-conditioning (A/C) button |
| 2. Fan control selector | 5. Recirculation button |
| 3. Air distribution mode selector | 6. Rear window defroster button* |

HEX0097

Temperature Control Selector

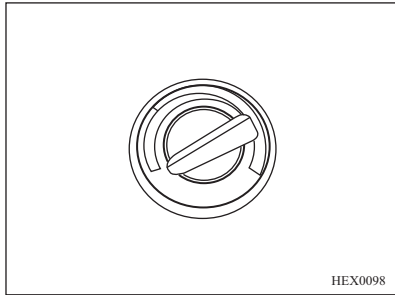

The temperature control selector controls the temperature of air flowing out of the vents.

Turn the temperature knob to the red area for warmer air or to the blue area for cooler air.

Fan Control Selector

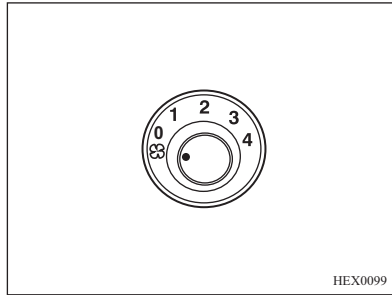

You can control the amount of airflow by turning the fan speed control knob. Turn the knob clockwise to increase fan speed, or counterclockwise to decrease fan speed.

You can set the fan speed control knob between 1 to 4, as desired.

Air Distribution Mode Selector

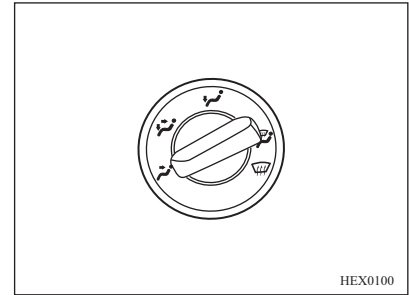

Turn the knob to the desired mode according to the desired airflow direction.

The air distribution selector can be set to one of the five positions as follows:

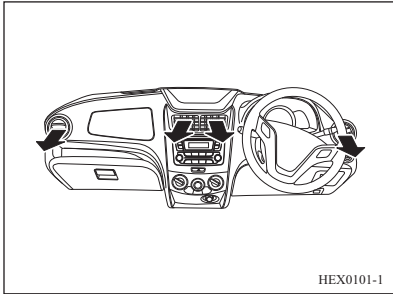
Front mode (↔)

This mode directs airflow through the center vents and side vents.

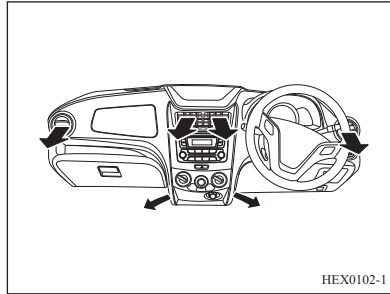
Dual mode (↔↕)

Directs air flow in two ways. Half of the air through the floor vents and the remaining through the center and side vents.

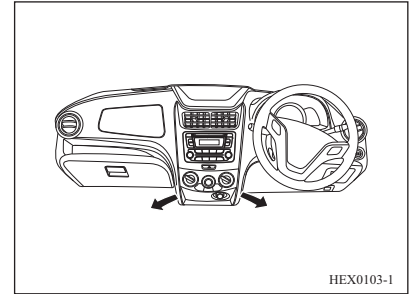
Floor mode (↕)

Most of the air flows through the floor vents, with a small amount of air through the windshield and front window defroster vents as well as side vents.

Floor/defrosting mode (👁️)

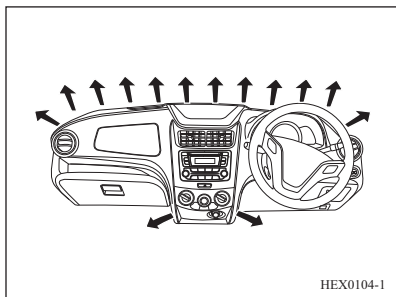

This mode directs airflow through the windshield defroster vent, front window vents, floor vents and side vents.

Note

In this mode, air conditioning system would automatically switch on the compressor and switch off the recirculation mode.

Defrosting mode (👁️)

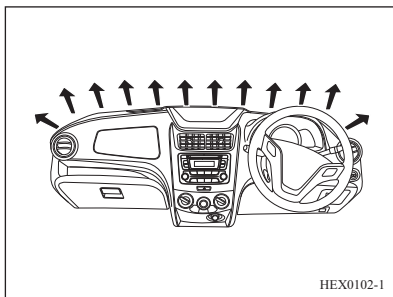

Air flows through windshield and front window defroster vents as well as side vents.

Note

In this mode, air conditioning system would automatically switch on the compressor and switch off the recirculation mode.

Recirculation Mode Button

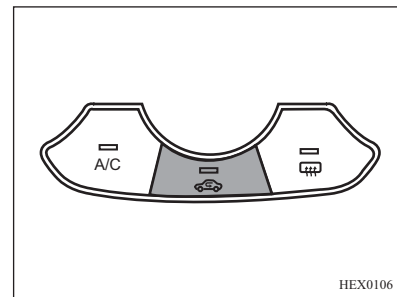

Press this button when driving in dusty conditions, to keep vehicle exhaust or smoke out, or when quick heating or cooling is desired. The indicator light on the button will illuminate and air recirculation will start.

Press the button again to switch to fresh air mode. The indicator light on the button will turn off.

⚠ Warning

Driving with recirculation mode for prolonged period of time can make you sleepy. Periodically turn to the outside air mode for fresh air.

The exchange of fresh air is reduced in air recirculation mode. In operation without cooling, the air humidity increases, so the windows may mist up. The quality of the passenger compartment air deteriorates, which may cause the vehicle occupants to feel drowsy.

AIR CONDITIONING SYSTEM

The refrigerant in the air conditioning system can cool down the air inside the vehicle, removing moisture from the air.

Even when the air conditioning system is on, your vehicle will produce warm air if the temperature control selector is set to a relatively high temperature.

Caution

You may notice a water drip from under the engine compartment sometimes after driving with air conditioning on.

This is normal because your cooling system removes moisture from the air.

Note

Because the compressor of the air-conditioning system shares the engine power, you may notice a slight drop in engine power and performance when the compressor is operating.

Air Conditioning Button

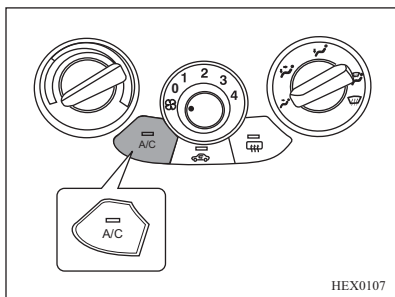

Caution

Using your air conditioning system while driving up long hills or in heavy traffic can cause the engine to overheat.

If the engine coolant temperature warning light indicates that the engine is overheating, turn the air conditioning off.

Otherwise your vehicle may be damaged.

Turning on air conditioning (A/C) system:

1. Start the engine.
2. Press the air conditioning (A/C) button. (The indicator light on the button turns on to indicate that the air conditioning is working.)
3. Adjust fan speed.

Note

The fan must be turned on for the air conditioning compressor to work.

Turning off air conditioning (A/C) system:



Press the air conditioning (A/C) button again. (The indicator light on the button turns off to indicate that the air conditioning stops working.)

The air conditioning system will turn on automatically when the vehicle is started, if it was working when the engine was shut down last time.

Cool Air



Maximize cooling

For quick cooling in hot weather or after the vehicle has been exposed to direct sunlight for an extended period of time:

1. Open the windows slightly to permit hot air to escape.
2. Turn on the air conditioning (A/C). (The indicator light turns on.)
3. Press the recirculation button . (The indicator light turns on.)
4. Turn the air distribution selector to front mode (.
5. Turn the temperature control selector to the maximum position in the blue area to obtain cool air.
6. Turn the fan control selector to the maximum speed.

Normal cooling

1. Turn on the air conditioning (A/C) button. (The indicator light turns on.)

2. Press the recirculation button . (The indicator light turns on.)
3. Turn the air distribution selector to front mode () or dual mode (.
4. Turn the temperature control selector to the blue area to obtain cool air.
5. Turn the fan control selector to a desired speed.



Warm Air

Maximize heating



Use the maximum warm air mode to quickly raise the temperature in the passenger compartment. Do not use this mode for an extended period of time, or the air quality inside the vehicle will deteriorate and the windows will mist up. To remove mist from the windows, bring in fresh air by turning off the recirculation button .

To obtain maximum warm air:

1. Turn off the air conditioning (A/C). (The indicator light turns off.)

2. Press the recirculation button . (The indicator light turns on.)
3. Turn the air distribution selector to dual mode () or floor mode (.
4. Turn the temperature control selector to the maximum position in the red area to obtain warm air.
5. Turn the fan control selector to the maximum speed.

Normal heating



1. Turn off the air conditioning (A/C). (The indicator light turns off.)
2. Turn off the recirculation . (The indicator light turns off.)
3. Turn the air distribution selector to floor mode () or dual mode (.
4. Turn the temperature control selector to the red area to obtain warm air.
5. Turn the fan control selector to a desired speed.

Ventilation

Dual mode

Suitable for a weather condition that is cool and full of sunshine. The warm air flows into the floor area and the cool air from outside flows to the upper part of the vehicle.

To use this setting:

1. Turn off the recirculation button . (The indicator light turns off.)
2. Turn the air distribution selector to dual mode (.
3. Turn the temperature control selector to a desired temperature.
4. Turn the fan control selector to a desired speed.

Ventilation

To direct airflow through the center vents and side vents:

1. Turn off the air conditioning (A/C). (The indicator light turns off.)
2. Turn off the recirculation . (The indicator light turns off.)

3. Turn the air distribution selector to front mode (↗) or dual mode (↔).
4. Turn the temperature control selector to the blue area to obtain cool air.
5. Turn the fan control selector to a desired speed.

Rear Window Defroster Button*

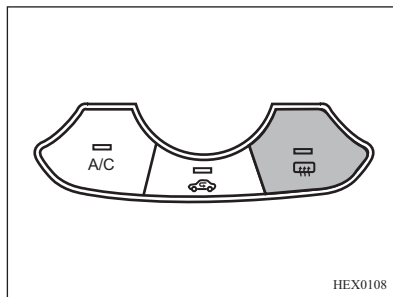

To turn on the defroster, switch ON the ignition and then press the rear window defroster button. The indicator light on the button will turn on.

The defroster will turn off approximately 12 minutes after the button is pressed.

Turn the defroster off when you are sure that your vision is clear.

Caution

Do not use the rear window defroster under the following conditions:

- Engine is not running
- Vehicle is not started
- There is a build-up of snow or ice on the rear window

Operating the rear window defroster under these conditions could drain the battery.

This can damage your vehicle, requiring the replacement of some parts.

Caution

Lack of proper maintenance can damage the defroster grid or scratch the glass.

Do not use sharp tools or abrasive window cleaners on the rear window.

Do not damage or scratch the defroster grid when cleaning the rear window or working around it.

Less than clear vision for the driver can lead to an accident resulting in personal injury and damage to your vehicle or other property.

DEFROSTING AND DEMISTING**Windshield defrosting:**

1. Turn the air distribution selector to defrosting () position.
2. Turn the temperature control selector to the red area to obtain warm air.
3. Turn the fan control selector to the maximum speed to accelerate defrosting.



Then the air conditioning system will automatically control the compressor operation and air recirculation mode. (Indicated by the A/C indicator light on and recirculation indicator light off.)

4. In order to keep the windshield clean and direct warm air to the floor, turn the air distribution selector to the floor/defrosting () position.

Then the air conditioning system will automatically control the compressor operation and air recirculation mode. (Indicated by the A/C indicator light on and recirculation indicator light off.)

Caution

A temperature difference between the outside air and the windshield can make the windshield mist up and reduce your forward vision.

Do not use the floor/defrosting mode () or the defrosting () mode in extremely humid weather when the temperature control is set to blue area.

Otherwise accidents can result, leading to vehicle damage and personal injury.

MAINTENANCE

Air Intake

The air intake in front of the windshield in the engine compartment must be kept clear to allow air intake.

Remove any leaves, dirt or snow.

A/C Mesh Filter

The filter prevents dust, particles, leaves, etc. from entering vehicle through air intake.

Note

We recommend that you consult your authorized CHEVROLET retailer to clean or replace the filter.

Caution

More frequent maintenance of the A/C filter is required if the driving circumstances are dusty roads, air pollution areas, and frequent unpaved roads.

It makes the filter efficiency to be decreased.

Air Conditioning Regular Operation

In order to ensure continuously efficient performance, cooling must be operated for a few minutes once a month, irrespective of the weather and time of year. Operation with cooling is not possible when outside temperature is low.

Service

For optimal cooling performance, it is recommended to annually check the climate control system.

- Functionality and pressure test
- Heating functionality
- Leakage check
- Check of drive belts
- Cleaning of condenser and evaporator drainage
- Performance check

Caution

Use only correct refrigerant.

Warning

Climate control systems are serviced by qualified personnel only. Improper service methods may cause personal injury.

DRIVING AND OPERATING

Driving Notes 85

 Vehicle Control 85

 Emergency Actions 85

 Driving with Diesel Engine Vehicle87

Starting and Operating 88

 New Vehicle Running-In Period ..88

 Ignition Switch Positions 88

 Immobilizer Operation.....90

 Start the Engine 90

 Parking 91

Manual Transmission 91

Brakes 92

 Anti-Lock Braking System* 93

 Parking Brake 94

Fuel 95

 Fuel Recommendations 95

 Filling the Tank 96

 Diesel Fuel System Bleeding98

Engine Exhaust 98

 Catalytic Converter 99

Suggestions for More Economical Operation 100

DRIVING NOTES

Vehicle Control

Do not coast the vehicle when the engine is not running.

Otherwise many systems (e.g. brake booster, power steering) will not work. Driving in this way is dangerous to yourself and others.

Pedals

Mats must not be placed in the pedal area. This may obstruct the pedal travel.

Emergency Actions

Caution

- Do not operate starter motor for more than 10 seconds at a time.
- If the engine does not start, wait 10 seconds before trying again.

This will prevent starter motor damage and battery discharge.

Puncture during driving

When driving, turn on the hazard flashers if a tire is punctured. Hold the steering wheel firmly, lift your foot off the accelerator pedal, and slow the vehicle gradually. Press the brake pedal

gently and drive the car into a safe area to change the tire.

Warning

Do not brake suddenly when a tire is punctured. Sudden braking may cause the vehicle to swing to one side and cause accidents.

Faults during driving

When a fault occurs while driving, turn on the hazard flashers. Park the vehicle in a safe area at the roadside.

A warning triangle should be placed behind the vehicle at a distance of 50 m during the day or 100 m at night.

A warning triangle is stored in the rear compartment at the time of vehicle delivery.

Consult your CHEVROLET retailer for inspection and repair.

Caution

Continuing to drive a vehicle with problems may cause accidents.

If the engine does not start

If the ignition switch is in the START position but the starter motor does not work, check the battery for charge, battery terminals are connected properly and concern fuse is blown out.

If the starter motor works but the engine does not start, check the oil level, the fuel filter, the fuel pump, the associated wiring, etc.

The fuel pump can be checked by listening to the sound when the ignition switch is turned ON.

Measures to be taken when the engine is over heated

While driving, if a sudden drop in power or the temperature warning light comes on, park the vehicle in a safe place and take the following measures.

- Run the engine at idle and then move the gear shift lever into neutral.
- Apply the parking brake.
- Turn off the air conditioning.
- Open the hood to ventilate the

engine compartment.

Warning

If steam or coolant escapes from the engine, do not open the hood, otherwise you may be scalded by the steam or coolant.

- If the coolant level does not drop while the engine is idling, switch off the engine to let it cool down. If the cooling fan does not work, switch off the engine to let it cool down.
- If the coolant level is too low, open the cap and fill the coolant tank with coolant very slowly.

Caution

Sudden filling of coolant into an over heated engine will damage the engine.

Caution

Do not open the coolant cap when the engine is hot else steam or coolant will escape and scald your face or body. Wait until the engine is completely cooled before opening the coolant cap.

Cover the coolant cap with a cloth, open it a little (1/2 turn) at first, and do not open it completely until the pressure inside has been released.

- After taking temporary measures, seek assistance from your CHEVROLET retailer for inspection and necessary repairs.

In case of fire

A fire might be caused by unauthorized changes to the electrical and fuel system or by accidents. Keep a fire extinguisher inside your vehicle.

No fire extinguisher is provided at the time of vehicle delivery.

⚠ Warning

The fire will soon spread to other parts of the car as the vehicle contains many combustible materials such as various oils, fibers, and plastics.

All passengers should immediately exit the vehicle and reach to a safe area.

Do not change the electrical or fuel systems without authorization, or a fire might be caused.

Use in the snow

- Slow down when turning a corner, driving uphill or crossing a bridge.
- Do not park the car on a hard verge or it may obstruct the snow clearing work.
- Keep a safe distance from other cars; avoid unnecessary braking.
- Frequent cleaning of the snow surrounding the vehicle can protect the exhaust pipe from being blocked.

Driving through deep water

When you are about to drive through deep water, you must check the puddle or standing water is not too deep. If you drive too quickly through deep water, water can enter your engine through the air intake causing severe damage.

Note

If your vehicle stops while driving through deep water, then do not start the engine and have your vehicle checked from CHEVROLET retailer.

Caution

Before attempting to drive through deep water, always observe the following precautions :

- Do not drive through water if the depth is slightly lower than the underbody of your vehicle.
- Drive as slow as you can at speed limit less than 10 km/h.

Driving with Diesel Engine Vehicle

The turbocharger element rotate very fast. If the oil supply to running parts stops, the turbocharger system may be seriously damaged. The owner should be encouraged to observe the following precautions to ensure maximum turbocharger service life.

- After starting the engine, let it run for about 1 to 2 minutes with idle speed (avoid acceleration or driving off the vehicle).
- Do not stop the engine immediately after coming back from the highload driving (such as high speed driving or driving down a long slope). Let the engine run for about 1 to 2 minutes at idle speed to cool it down.
- After changing the engine oil and oil filter, start the engine and let it run for about 1 to 2 minutes with idle speed (avoid acceleration or driving off the vehicle).

STARTING AND OPERATING

New Vehicle Running-In Period

Use the following precautions for the first few hundred kilometers to improve the performance and economy of your vehicle and add to its long life:

- Operate the engine above idle only after normal engine oil pressure has been established. Forcing the turbocharger to operate before the bearings are adequately lubricated creates unnecessary friction.
- Use only the specified engine oil and observe inspection and replacement intervals.
- At low ambient temperature, or when the vehicle has not been used for a long period, normal engine oil pressure and flow is affected. Under these conditions the engine should be started and allowed to idle for a few minutes before operating at higher rpm.
- Avoid full-throttle starts.
- Allow the engine to warm up before driving.
- Do not race the engine.
- Avoid hard stops except in emergencies. This will allow your brakes to bed in properly.
- Avoid quick starts, sudden accelerations, and prolonged high-speed driving in order to avoid damage to the engine and to conserve fuel.
- Avoid full-throttle acceleration in low gear.
- Do not tow any other vehicle.

Ignition Switch Positions

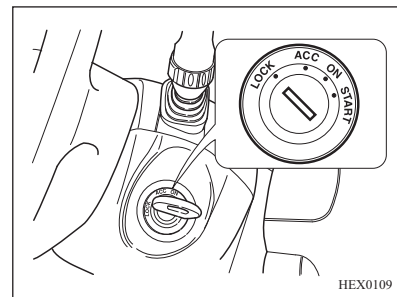

Located to the right side of steering column, the ignition switch has the following positions: LOCK, ACC, ON, and START.

- **LOCK**

To lock the steering wheel, remove the key and turn the steering wheel clockwise until it is locked.

In order to operate the key while unlocking the steering wheel, turn the steering wheel from left to right gently and then turn the key to the ACC position.

- **ACC/ACCESSORY**

Turning the ignition key to the position ACC/ACCESSORY will turn off the engine without locking the steering wheel. To turn the ignition key from the position ACC/ACCESSORY to LOCK, gently press the key and turn it to the position LOCK.

When the ignition key is in the position ACC/ACCESSORY, some electrical accessories such as the audio system and accessory power outlet can be used.

Caution

Do not leave the key in the ACC/ACCESSORY position for a long time.
Otherwise it will discharge the battery.

- **ON**

Start ignition system and electrical accessories.

Caution

When the engine is not running, do not leave the key in the ON position for a long time.
Otherwise it will discharge the battery.

- **START**

Start the engine. Then release the key and it will automatically return to the ON position.

Make sure that the engine is not running before turning the ignition key to the START position.

Caution

When driving, do not turn the key to the OFF position.

Otherwise the driver will lose control over the car and the brake booster will not function properly, which will lead to vehicle damage and injury.

Caution

Do not operate the key through the steering wheel.

Otherwise the steering wheel may turn suddenly, causing the driver to lose control over the vehicle and lead to vehicle damage and injury.

Immobilizer Operation

The immobilizer system provides an additional theft deterrent to your vehicle in which it is installed and prevents it from being started by unauthorized persons. The valid key for a vehicle equipped with immobilizer system is an ignition key with integrated transponder, which is electronically coded. The transponder is placed invisibly in the ignition key.

Only valid ignition keys can be used to start the engine.

Invalid keys may only open the doors.

The engine is automatically immobilized after the key is turned to LOCK and has been removed from the ignition switch.

Start the Engine

Before starting the engine:

- Make sure there are no obstacles around the vehicle.
- Make sure that all windows and lights are clean and transparent.
- Check the tire condition, inflation pressure and look for foreign objects.
- Adjust the head restraint to the appropriate position.
- Adjust the interior rear view mirror and exterior rear view mirrors.
- Fasten the safety belt correctly and make sure that all passengers fasten their belts.
- When the key is turned to the ON position, check that the warning lights and indicators on the instrument panel work.
- Check maintenance items recorded in this Manual regularly (for example when the vehicle is being refueled).

Caution

Do not keep the starter motor running for more than 10 seconds.

If the engine does not start, please wait for 10 seconds and try again.

This can prevent damages to the starter motor and battery discharge.

Caution

- Do not idle the engine at high rpm for more than 3 minutes.

Excessive temperature can damage the exhaust system / catalytic converter.

Parking

- Do not park the car on a flammable base.
- When using the parking brake, do not press the release button. Apply the parking brake firmly when the vehicle is parked on an upward or a downward slope, and meanwhile depress the foot brake to reduce the force applied.
- After running at high engine speeds or with high engine loads, operate the diesel engine briefly at a low load or run in neutral for about 1 to 2 minutes at idle speed before switching off in order to protect the turbo charger.
- Turn off the engine and ignition switch. Turn the steering wheel clockwise until the steering wheel is locked.

For vehicles equipped with manual transmission:

1. When the car is parked on level ground, place the shift lever in the neutral position.
2. When the car is parked on a downward slope, place the shift lever in the reverse position.
3. When the car is parked on an upward slope, put the shift lever into first gear.

MANUAL TRANSMISSION

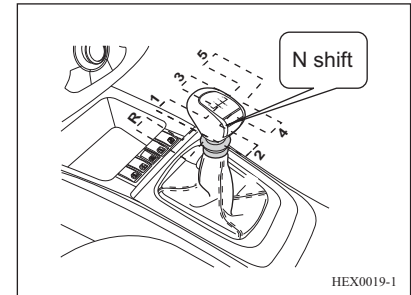

To change gears, fully depress the clutch pedal, move the gearshift lever into gear, and slowly release the clutch pedal.

To engage reverse, with the vehicle stationary pull up the ring on the selector lever and engage the gear.

If the gear does not engage, set the lever in neutral, release the clutch pedal and depress again; then repeat gear selection.

Do not grind the clutch unnecessarily. When operating, depress the clutch pedal completely. Do not use the pedal as a footrest.

Caution

It is inadvisable to drive with hand resting on the shift lever.

Caution

Shifting to R (Reverse) while the vehicle is moving forward could damage the transmission. The repairs would not be covered by the vehicle warranty. Shift to R (Reverse) only after the vehicle is stopped.

BRAKES

The braking system is designed to brake the vehicle under any conditions.

There are disc brakes for the front wheels and drum brakes for rear wheels. A dual-circuit brake system is used.

If one brake circuit is ineffective, the other circuit can still be used to stop the vehicle but the braking distance will increase and depressing the brake pedal will also require a greater force.

Caution

If one of the brake circuit fails, depressing the brake pedal will be difficult and the braking distance will also increase. Contact your CHEVROLET retailer to check and repair the braking system.

An increase in brake pedal travel indicates that the brakes may need repair. Consult your CHEVROLET retailer.

Caution

Do not put your foot on brake pedal during driving. Otherwise the wear on the brake components will be accelerated.

Also the brakes will overheat so that the braking distance is increased and safety is reduced.

Caution

The brake may temporarily lose function after the car has driven through water or has been washed, or when the brake is overused while the car is driving down a long steep slope. This may be due to the brakes are wet or overheated.

If the brakes temporarily lose its function because of overheating:

Shift to a lower gear when driving downhill.

Take the following steps if the brakes temporarily lose function due to wet components:

1. Check whether there is any vehicle following.
2. Maintain a safe speed, make sure that there is enough space behind and to both sides of your vehicle.
3. Depress the brake carefully until performance returns to normal.

Anti-Lock Braking System*

Your vehicle may be equipped with this function.

The Anti-lock Braking System is an advanced electronic brake system which helps to prevent slip and skidding. This system can help to bypass obstacles when braking suddenly and provide maximum braking force on slippery roads.

The ABS warning light will light momentarily when the ignition switch is turned ON. If the ABS warning light stays on or lights during driving, it indicates a problem with the ABS.

Consult your CHEVROLET retailer for necessary repair. See ABS Warning Light on page 59.

The ABS system will monitor the speed of each wheel during the braking process. If one wheel has a tendency to lock up, the system will control the front and rear wheel brakes separately. The brake pedal will usually vibrate slightly with some noise when ABS is working.

Caution

ABS will not change the time needed for braking, neither it will necessarily shorten the braking distance. Even if ABS is equipped, an adequate braking distance should be maintained.

Faults

Warning

If there is a fault in the ABS, the wheels may be liable to lock due to braking that is heavier than normal. The advantages of ABS are no longer available. During hard braking, the vehicle can no longer be steered and may swerve.

Have the cause of the fault remedied by a CHEVROLET retailer.

Using ABS

Do not pump the brakes. Just hold the brake pedal down firmly and let ABS work. You might hear the ABS pump or motor operating and feel the brake pedal pulsate, but this is normal.

Braking in Emergencies

ABS allows the driver to steer and brake at the same time. In many emergencies, steering can help more than even the very best braking.

Parking Brake

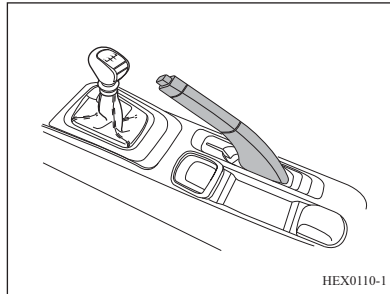

The parking brake acts on the rear wheels.

The parking brake lever is positioned between the front seats.

When using the parking brake, stop the vehicle, depress the brake pedal and pull the parking brake lever.

To release the parking brake, depress the brake pedal, and

1. Pull the parking brake lever slightly.
2. Push the button at the end of the brake lever.
3. Lower the brake lever while pressing the button.

Warning

If the parking brake is not set properly, the vehicle may move suddenly. See your CHEVROLET retailer if an adjustment is required.

Caution

Do not drive with the parking brake on.

This can cause your rear brakes to overheat or wear out prematurely. You may have to replace them, and you could damage other parts of your vehicle.

Caution

Do not park or operate your vehicle over combustible materials.

They could touch hot exhaust parts under your vehicle and ignite.

FUEL

Fuel Recommendations

Only use diesel fuel that complies with DIN EN 590. The fuel must have low Sulphur content (max. 50ppm).

Do not use marine diesel oils, heating oils or entirely or partially plant-based diesel fuels, such as rape seed oil or bio diesel, Aquazole and similar diesel-water emulsions. Diesel fuels must not be diluted with fuels used on petrol engines.

The flow and filterability of diesel fuel are temperature-dependent. When temperatures are low, refuel with diesel fuel with guaranteed winter properties.

Caution

Use of fuel that does not comply to EN 590 or similar can lead to engine powerloss, increased wear or engine damage and loss of warranty.

Caution

The use of incorrect grade of fuel or filling in the fuel tank with incorrect fuel will cause serious damage to the engine and catalytic converter.

Make sure you use the correct fuel that is compatible with your vehicle.

For safety purposes, the fuel tank, pumps and piping must be suitably grounded. Static electricity can ignite fuel vapours. You may be burned and the vehicle will be damaged.

Caution

The usage of low cetane fuel can result in uncontrolled combustion and engine damage. The vehicle is designed to exclude the use of methanol fuel which will corrode the metal parts in the fuel system and damage plastic and rubber parts. Therefore damage caused by using methanol fuel is not covered by the warranty.

Fuel with excessive levels of manganese and iron may result in blockage of the three-way catalytic converter and other problems.

⚠ Danger

Before adding fuel, switch off the engine and any external combustion heating device.

Turn off cell phones. When adding fuel, observe the operation and safety instructions of the fuel station.

⚠ Danger

Fuel is a flammable and explosive material.

No smoking. No open flames or sparks.

If you can smell fuel in your vehicle, have the cause of this remedied immediately by a CHEVROLET retailer.

Do not use methanol

Fuel containing methanol must not be used in this vehicle. This type of fuel will degrade the vehicle performance and damage the parts in fuel system.

Caution

The use of methanol will result in damage to the fuel system.

Therefore damage caused by using methanol fuel is not within the scope of warranty.

Driving in other countries

When driving your vehicle in other countries:

- Comply with all the registration and insurance regulations.
- Make sure that correct fuel is available.

Filling the Tank

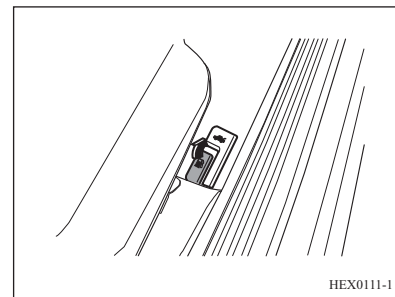

1. Switch off the engine.
2. Pull the release lever for the fuel filler cap, which is mounted on the floor on right side of the driver seat.

Note

If the fuel filler door does not open in cold weather, tap the door lightly. Then try to open it again.

Caution

Be sure to use the correct fuel (diesel) corresponding to your vehicle when refueling. If you fill petrol in your diesel powered vehicle, your vehicle can be seriously damaged. If your vehicle has diesel engine you can confirm the correct fuel by taking a look at information on the fuel filler cap.

For safety reasons, fuel containers, pumps and hoses must be properly earthed. Static electricity build up can ignite the fuel vapor. You can be burnt and your vehicle may get damaged.

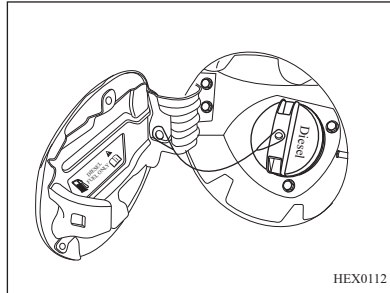

3. Turn the fuel filler cap counter-clockwise. If there is a hissing sound, wait until it stops before unscrewing the cap. The fuel filler door is in the left rear quarter panel.
4. Open the cap. The cap is tethered to the vehicle.

⚠ Danger

If you can smell fuel in your vehicle, have the cause of this remedied immediately by a CHEVROLET retailer.

Caution

Fuel vapor is highly flammable. Make sure that fuel is kept away from sparks, flames and other hot materials

Switch off the engine.

Ignition of fuel vapor will result in serious burns to people and damage to your vehicle.

5. After refueling, refit cap. Turn it clockwise until you hear a click.
6. Push the fuel filler door closed until it latches.

Caution

Avoid fuel splashes on the painted surface of vehicle.

In case of splashes on the vehicle, rinse the parts with clean cold water immediately.

Otherwise the fuel will damage the paint.

Danger

Before refueling, switch off engine and any external heaters with combustion chambers. Switch off any mobile phone.

Vaporised fuel can be ignited by electromagnetic waves or electric current of mobile phone.

Fuel is flammable and explosive. No smoking. No naked flames or sparks. Follow the operating and safety instructions of the filling station when refueling.

Remove static electricity on your hands by touching something able to release static electricity when touching or opening fuel cap or refueling nozzle.

Caution

Wipe off any overflowing fuel immediately.

Fuel filler cap

Only a genuine fuel filler cap provides full functionality. Diesel-engined vehicles have special fuel filler caps.

Diesel Fuel System Bleeding

If the tank has been run dry, the diesel fuel system must be bled on ground level after fueling at least 2 liters. Switch on the ignition three times for 15 seconds at a time. Then start the engine for a maximum of 10 seconds. Repeat this process after no less than 10 seconds. If the engine fails to start, seek the assistance of CHEVROLET retailer.

ENGINE EXHAUST

Danger

Engine exhaust gases contain poisonous carbon monoxide, which is colourless and odourless and could be fatal if inhaled.

If exhaust gases enter the interior of the vehicle, open the windows. Have the cause of the fault rectified by a CHEVROLET retailer.

Avoid driving with an open load compartment, otherwise exhaust gases could enter the vehicle.

▲ Warning

Engine exhaust contains carbon monoxide (CO) which cannot be seen or smelt. Exposure to CO can cause unconsciousness and even death.

Exhaust may enter the vehicle if:

- The vehicle idles in areas with poor ventilation (parking garages, tunnels, deep snow that may block underbody airflow or tail pipes).
- The exhaust smells or sounds strange or different.
- The exhaust system leaks due to corrosion or damage.
- The vehicle exhaust system has been modified, damaged or improperly repaired.

(Continued)

▲ Warning (Continued)

- There are holes or openings in the vehicle body from damage or aftermarket modifications that are not completely sealed.

If unusual fumes are detected or if it is suspected that exhaust is coming into the vehicle:

- Drive it only with the windows completely down.
- Have the vehicle repaired immediately.

Never park the vehicle with the engine running in an enclosed area such as a garage or a building that has no fresh air ventilation.

Catalytic Converter

The catalytic converter reduces the amount of harmful substances in the exhaust gas.

Caution

The usage of fuel other than those mentioned on pages Fuel Recommendations on page 95, could damage the catalytic converter or electronic components.

Unburnt fuel will overheat and damage the catalytic converter. Therefore avoid excessive use of the starter, running the fuel tank dry and starting the engine by pushing or towing.

In the event of misfiring, uneven engine running, a reduction in engine performance or other unusual problems, have the cause of the fault rectified by a CHEVROLET retailer as soon as possible.

In an emergency, driving can be continued for a short period, keeping vehicle speed and engine speed low.

Caution

Don't touch the catalytic converter during engine operating and it can be possible to touch the catalytic converter after cooling down the catalytic converter because the catalytic converter is very hot so the skin (i.e. hand or body) can be burned: cooling down condition-cool down over two hours under ambient temperature after engine stop.

SUGGESTIONS FOR MORE ECONOMICAL OPERATION

Fuel economy is dependent largely on your style of driving.

How you drive, where you drive and when you drive affect how many kilometers you can get from a litre of fuel.

To obtain maximum fuel economy:

- Accelerate slowly.
- Avoid unnecessary idling.
- Keep the engine properly tuned.
- Do not race the engine.
- Use the air conditioning only when necessary.
- Slow down when driving on rough roads.
- Keep the tires inflated to the recommended pressure.
- Maintain a safe distance from other vehicles to avoid a collision in case of sudden stops. This will also reduce wear on the brake pads and linings.
- Do not carry unnecessary weight.
- Do not rest your foot on the brake pedal while driving and follow the maintenance schedule.

VEHICLE MAINTENANCE

General Information	102	Drive Belt	114	Dome Light	125
Accessories and Modifications ..	102	Battery	114	Rear Cargo Area Light*	125
Vehicle Storage	102	Cleaning Battery Terminals	114	Bulb Specifications	126
Radio Frequency Identification		Battery Maintenance	115	Wheels and Tires	127
(RFID) Tag*	103	Brake Pedal	116	Maintenance	127
Driver's Checklist	103	Checking the Brake Pedal		Integrated Tread Wear	
Exterior	103	Free Play	116	Indicator	128
Interior	103	Parking Brake	116	Tire Rotation	129
Engine Compartment Overview ..	104	Checking the Parking Brake		Winter Tires	129
Engine Oil	105	Travel	116	Spare Wheel, Jack and Tools ...	130
Check the Engine Oil Level	105	Fuses	117	Jump Starting the Engine	133
Replace Engine Oil and		Fuse Blocks	118	Towing the Vehicle	136
Oil Filter	107	Passenger Compartment		Emergency Towing	137
Coolant	108	Fuse Block	119	Front Towing Hook	138
Brake / Clutch Fluid	109	Engine Compartment		Towing Hook for Shipping	139
Adding Brake / Clutch Fluid	110	Fuse Block	120	Rocking Your Vehicle	139
Transmission Fluid	111	Bulb Replacement	121	Vehicle Maintenance	140
Check the Transmission Fluid		Headlights	121	Cleaners	140
for Leakage	111	Parking Lights	122	Interior Maintenance and	
Power Steering Fluid	111	Front Turn Signal Lights	122	Cleaning	141
Check the Power Steering Fluid		Front Fog Lights*	123	Maintenance of Safety Belts	142
Level	111	Side Turn Signal Lights	123	Glass Surface	142
Adding Power Steering Fluid ..	111	Reverse Lights, Tail Lights,		Exterior Maintenance and	
Windshield Washer Fluid	112	Stoplights and Rear Turn		Cleaning	143
Windshield Wipers	113	Signal Lights	123	Preventing Corrosion	144
Replacing Wiper Blades	113	Central High-Mounted		Service and Maintenance	145
Air Filter	114	Stoplight	124	General Information	145
Cleaning the Air Filter	114	License-Plate Light	125	Scheduled Maintenance	146

GENERAL INFORMATION

Accessories and Modifications

We recommend to use genuine parts and accessories and factory approved parts specific for your vehicle type. We cannot assess or guarantee reliability of other products - even if they have a regulatory or otherwise granted approval.

Do not make any modifications to the electrical system e.g. changes of electronic control units (chip turning).

Caution

Never modify your vehicle. It may affect the performance, durability and safety of the vehicle and the warranty may not cover any problems caused by the modification.

Vehicle Storage

Storage for a long period of time

If the vehicle is to be stored for several months:

- Wash and wax the vehicle.
- Have the wax in the engine compartment and underbody checked.
- Clean and preserve rubber seals.
- Change engine oil.
- Drain washer fluid reservoir.
- Check coolant anti-freeze and corrosion protection.
- Adjust tire pressure to the value specified for full load.
- Park the vehicle in a dry, well ventilated place. For manual transmission, engage first or reverse gear. Prevent the vehicle from rolling.
- Do not apply the parking brake.
- Open the hood, close all doors and lock the vehicle.

- Disconnect the clamp from the negative terminal of the vehicle battery.
- Close the hood.

Putting back into operation

When the vehicle is to be put back into operation:

- Connect the clamp to the negative terminal of the vehicle battery. Activate the electronics of the power windows.
- Check tire pressure.
- Fill up the washer fluid reservoir.
- Check the engine oil level.
- Check the coolant level.
- Fit the number plate if necessary.

Radio Frequency Identification (RFID) Tag *

This vehicle is equipped with Radio Frequency Identification (RFID) tag*, which can be used for Electronic Toll Collection (ETC) or any other applications as decided by the Regulatory authority. The RFID tag is located on inside the windshield. Data for necessary applications will be added by the agency authorized by the Regulatory authority, from time to time. Take proper care during washing or cleaning of windshield so as to avoid any damage to the RFID tag. In case of any damage or malfunction of RFID tag, or in case of windshield replacement, contact your CHEVROLET retailer or agency authorized by the Regulatory authority for the installation of new RFID tag.

Caution

Do not touch or peel off. Do not place any sticker or other metallic components over the RFID tag neither from inside nor from outside of the windshield. Avoid exposure to chemicals or liquid solvents. This will impair the function of RFID tag. The RFID tag is tamperproof and will not function once removed from windshield.

DRIVER'S CHECKLIST

Regularly check the interior, exterior and engine compartment of the vehicle to ensure safety and reliability.

Caution

Chevrolet recommends to consult authorized CHEVROLET retailer for instructions and vehicle health check-up before setting out a long journey.

Exterior

Tires

- Inflate the tires correctly. See Wheels and Tires on page 127.
- The tire walls and treads must be free from cracks.
- The tread pattern must not contain any foreign bodies.

Lights

- Check the parking lights, headlights, tail lights, turn signals, brake lights, reverse lights and fog lights (if equipped) are working properly.

Oil and fluid

- Check the fluid level of all reservoirs under the hood is correct.

Windshield wipers

- Check the conditions of wiper arms and blades (including the rear wipers, if equipped).

Interior

Turning

- Check whether the steering wheel is too loose (free play).

Parking brake

- Ensure the parking brake lever has the correct travel.

Instrument panel

- Check whether all the instruments, controls and warning lights on the instrument panel work properly.

Rear view mirrors

- Ensure all three rear view mirrors are clean and in good condition.
- Check all the rear view mirrors can be adjusted.

Controls

- Check the travel of the brake pedal and clutch pedal is correct.

ENGINE COMPARTMENT OVERVIEW

1.3L Diesel Engine (LDV)

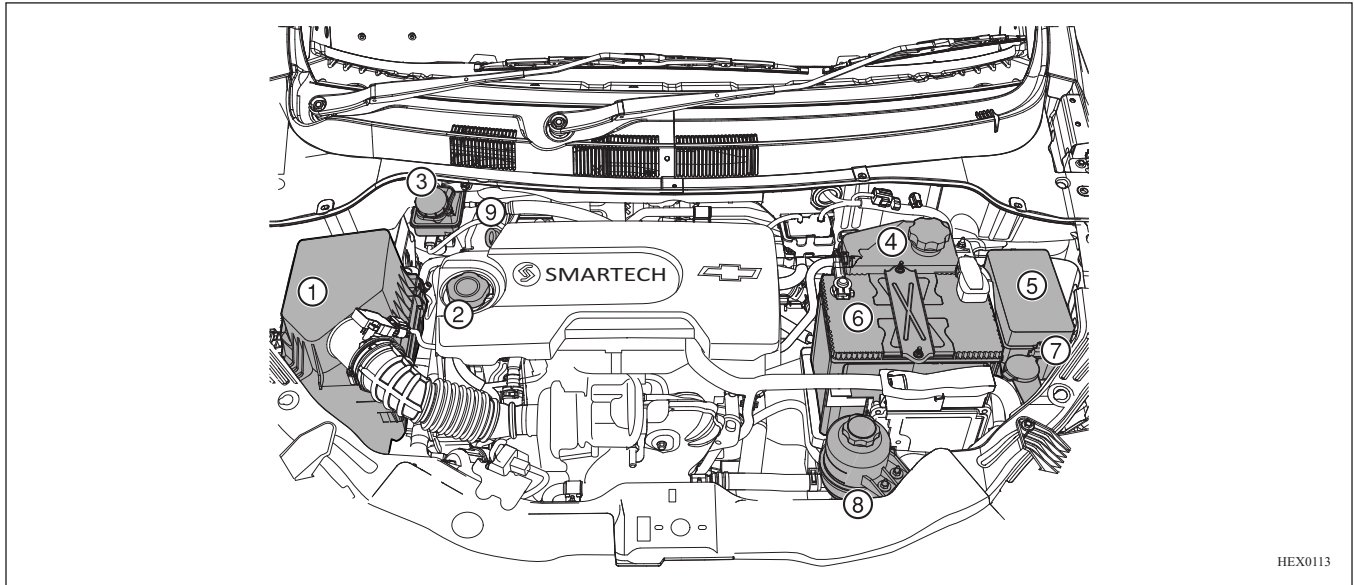

HEX0113

- | | | |
|-----------------------------------|-------------------------|--------------------------------------|
| 1. Air filter | 4. Coolant reservoir | 7. Windshield washer fluid reservoir |
| 2. Engine oil filler cap | 5. Fuse and relay block | 8. Power steering fluid reservoir |
| 3. Brake / Clutch fluid reservoir | 6. Battery | 9. Engine oil dipstick |

ENGINE OIL

Engine oil must be kept at correct levels to ensure proper lubrication of the engine.

It is normal for an engine to consume some oil.

Check the oil level at regular intervals, such as when refueling.

If the engine oil pressure light  on the instrument panel comes on, it means you should check the oil level immediately.

Check the Engine Oil Level

1. Park the vehicle on level ground.
2. Stop the engine and wait a few minutes for the oil to drain back into the oil pan. If the engine is cold, it will take longer for the oil to drain back into the oil pan.
3. Remove the dipstick and wipe it clean.
4. Reinsert the dipstick completely.
5. Remove the dipstick again.

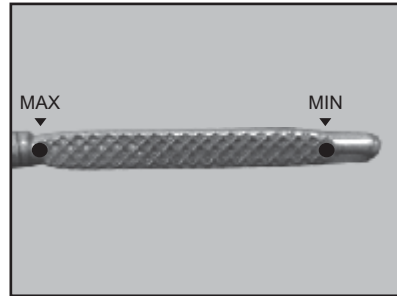

6. Check the oil level on the dipstick. Make sure the oil is not contaminated.
7. Check the oil level by using the oil dipstick. The level should be between the MIN and MAX limits.
8. Add engine oil of the same grade as recommended, if the level is below the lower limit. Bring the level up to but not above the upper limit.

The engine oil filler cap is located on the cylinder head cover. See the Engine Compartment Overview on page 104.

Warning

Engine oil is irritant and, if ingested, can cause illness or death.

Keep out of reach of children.

Avoid repeated or prolonged contact with skin.

Wash exposed areas with soap and water or hand cleaner.

Caution

Overfilling the engine with oil may affect the operation of engine.

The upper limit mark on the dipstick must not be exceeded.

Overfilling may damage the vehicle, because:

- The engine oil consumption will be increased.
- Excessive carbon accumulation on the engine.

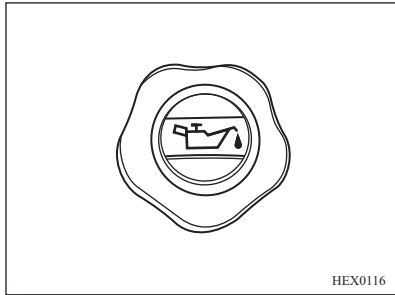

Choosing the Right Oil Quality

Caution

Use of unauthorized or low quality engine oil could damage the engine.

Be sure the engine oil you use has the ACEA A3/B4 rating.

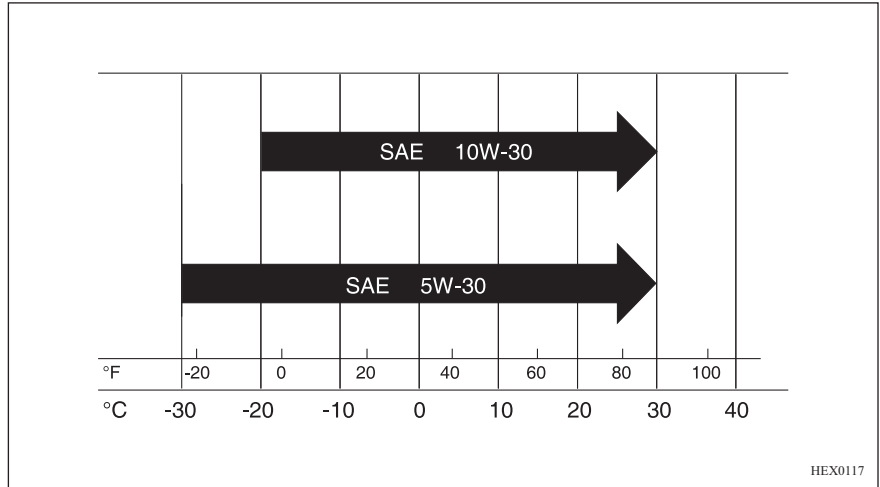

Choosing the Right Oil Viscosity

SAE 5W-30 is the recommended engine oil for your vehicle.

When choosing an oil, consider the range of temperature your vehicle will be operated in before the next oil change. Then, select the recommended oil viscosity from the chart.

Do not switch to a different viscosity in the event of brief temperature change.

Caution

Using engine oils of a viscosity other than recommended could result in engine damage and repair not covered under warranty.

Engine Oil Additives/Engine Oil Flushes

Do not add anything to the oil. The use of engine oil additives could cause engine damage not covered by the vehicle warranty. Engine oil system flushes are not recommended and could cause engine damage not covered by the vehicle warranty.

Replace Engine Oil and Oil Filter

Caution

This job requires special skills, tools and equipment.

Be sure you are competent for this job before attempting to complete it.

If you are not confident, you must have the work done by your CHEVROLET retailer.

Otherwise, you could be injured or your vehicle could be damaged.

Engine oil loses its ability to lubricate when contaminated. Make sure you change your engine oil according to the maintenance schedule.

Make sure you replace the engine oil filter each time you change the engine oil.

Under severe conditions, you must change the oil and filter more frequently than is recommended in the standard maintenance schedule.

Severe conditions include, but are not limited to:

- Frequent cold starting.
- Frequent driving in stop and go traffic.
- Frequent short trips.
- Frequent driving when the outside temperature remains below freezing.
- Prolonged idling.
- Frequent low-speed driving.
- Driving in dusty areas.

Caution

Use of unauthorized or low quality engine oil or chemical engine treatments (additives) can damage the engine and void your vehicle warranty.

⚠ Warning

Engine oil and its containers can be hazardous to your health.

Avoid repeated or prolonged contact with engine oil.

Clean your skin and nails with soap and water, or hand cleaner after handling engine oil. Also keep this and other toxic materials out of the reach of children.

Engine oil can irritate the skin and can cause illness and even death if swallowed.

Caution

Do not dispose of used engine oil and filter with your household waste.

See your local, authorized waste management facility.

Used engine oil and filter contain harmful elements that may be unhealthy to you and threat to the environment.

COOLANT

Your vehicle cooling system is filled with ethylene glycol based long life coolant.

In the correct mixture, this coolant provides the cooling and heating system with excellent protection against corrosion and freezing.

When the engine is cool, the coolant level should be between the MIN and MAX mark on the coolant reservoir. The level of coolant rises as the engine warms and drops back as the engine cools.

Caution

Plain water or the wrong mixture can damage the cooling system.

Do not use plain water, alcohol or methanol antifreeze in coolant system.

Use only General Motors India Pvt. Ltd. recommended coolant available with your CHEVROLET retailer.

The engine may overheat or even catch fire.

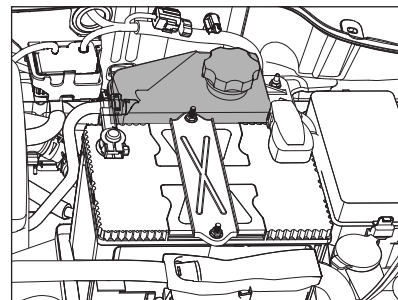

If the coolant level falls below the MIN mark, refill the reservoir with General Motors India Pvt. Ltd. recommended coolant available with your CHEVROLET retailer, but only when the engine is cool. In order to protect your vehicle in extremely cold weather, use GMI approved coolant.

Caution

In cold weather, water can freeze and crack the engine, radiator, heater core and other parts. Use the recommended coolant and the proper coolant mixture.

⚠ Warning

Scalding hot coolant and steam could be blown out under pressure, which could cause serious injury.
Never remove the coolant reservoir cap when the engine and radiator are hot.

Caution

It is not needed to add coolant more frequently than the recommended interval. If you are adding coolant often, this may be a sign that your engine needs maintenance.
Contact your CHEVROLET retailer for a check of the cooling system.

⚠ Warning

You can be burned if you spill coolant on hot engine parts. Coolant contains ethylene glycol and it will burn if the engine parts are hot enough. Do not spill coolant on a hot engine.

Caution

Coolant can be hazardous material.
Avoid repeated or prolonged contact with coolant.
Clean your skin and nails with soap and water after coming in contact with coolant.
Keep coolant out of reach of children.
Coolant can irritate the skin and can cause illness or death if swallowed.

Caution

If an improper coolant mixture or extra inhibitors and/or additives is used, the engine could overheat and be badly damaged. The repair cost would not be covered by the vehicle warranty. Too much water in the mixture can freeze and crack the engine, radiator, heater core, and other parts.

BRAKE / CLUTCH FLUID

The brake/clutch fluid can absorb moisture. Too much water in the fluid will reduce the efficiency of the brake / clutch system. Corrosion in the hydraulic system can be prevented by changing the fluid in accordance with the instructions in this Manual.

Use only recommended brake / clutch fluid. Keep reservoir filled to the proper level. Do not allow the level to fall below MIN mark or to raise beyond the MAX mark.

A low fluid level in the brake/clutch fluid reservoir can be either an indication of a leak in the brake/clutch system or a normal indication caused by usual brake pad/lining wear. Consult your CHEVROLET retailer to determine if the system needs repair and add fluid after work is done on your hydraulic brake / clutch system if it is required.

If the brake / clutch fluid level is low, the brake system warning light (⚠) will come on. See Warning Light for Brake System on page 61.

Adding Brake / Clutch Fluid

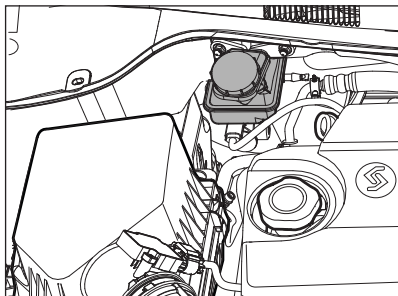

1. Thoroughly wipe and clean the area around the filler cap.

Caution

Make sure the area near the filler cap of brake/clutch reservoir is thoroughly cleaned before removing the cap.

Contaminated brake/clutch fluid can affect performance and lead to costly repairs.

2. Remove the cap.
3. Add enough recommended brake / clutch fluid to bring the level up to the MAX mark. Be careful not to spill brake/clutch fluid on the painted surfaces of the vehicle. If you do, wash it off with cold water immediately.

Caution

Brake / clutch fluid can catch fire if spilt on the engine.

Wipe off the top of the reservoir.

If the engine catches fire, it could cause personal injuries and damage to your vehicle and other property.

4. Refit the cap.

Caution

Do not dispose of used brake / clutch fluid with your household waste.

Use your local, authorized waste management facility.

Used brake / clutch fluid and their containers are hazardous. They can damage your health and the environment.

Caution

The brake / clutch fluid is irritative to skin and eyes.

Do not let brake / clutch fluid touch your skin or eyes. If you do get it in your eyes or on your skin, wash the affected area thoroughly with soap and water or hand cleaner.

TRANSMISSION FLUID

Check the Transmission Fluid for Leakage

This job requires special skills and equipment. In order to prevent personal injury or vehicle damage, we suggest you to have this work done at your CHEVROLET retailer.

Note

Use of the incorrect fluid may damage the vehicle. Always use the fluid listed in Fluid Chart on page 152.

POWER STEERING FLUID

Check the Power Steering Fluid Level

Check the power steering fluid level regularly.

The power steering fluid reservoir is located next to the battery.

Caution

Do not operate vehicle without the required amount of power steering fluid.

Doing so can damage power steering system of your vehicle, leading to costly repairs.

1. Switch off the engine.
2. Check the fluid level in the reservoir. The level should be between the MIN and MAX marks.

If the fluid is below the MIN mark, fluid should be added according to the instructions in this Manual.

Adding Power Steering Fluid

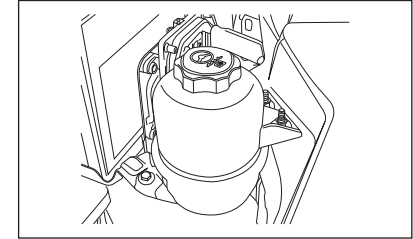

1. Wipe and clean the cap and top surface.
2. Remove the cap.
3. Add power steering fluid. The fluid level should be kept between the MIN and MAX marks.
4. Refit the cap.

Warning

An overflow of the fluid may cause the fluid to burn or discolor paintwork.

Do not overfill the reservoir.

An engine fire can cause personal injuries and damage your vehicle and other property.

WINDSHIELD WASHER FLUID

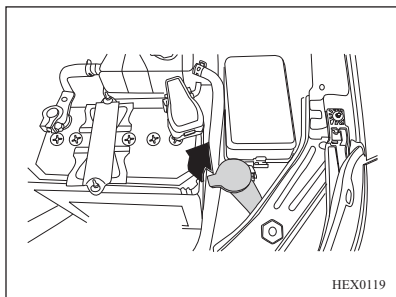

Before you drive, make sure the windshield washer fluid reservoir is at the appropriate level and filled with the correct solution.

In cold weather, do not fill the windshield washer fluid reservoir more than three quarters full.

Washer fluid can freeze to expand in cold temperature. Filling the reservoir too much does not allow enough expansion room to prevent possible damage to the reservoir.

Caution

When adding windshield washer fluid:

It is recommended to use special ready-to-use washer fluid. If concentrated washer fluid is to be used, please add water to dilute the fluid according to instructions of the manufacturer.

Do not use plain water. The minerals or foreign substances in plain water can clog the pipes of the windshield washer.

If the air temperature is likely to fall below freezing, use windshield washer fluid which has sufficient anti-freeze properties.

Caution

Do not put water or radiator antifreeze in the windshield washer reservoir.

Water can make the solution freeze. A frozen solution could damage the windshield washer system.

The radiator antifreeze can damage your washer system and paint.

WINDSHIELD WIPERS

Keeping the windshield wipers working properly is necessary to ensure clear vision and safe driving.

Check the conditions of wiper blades regularly. Replace any wiper blade that is hard, vibrating, cracked or smeared with dirt.

The effectiveness of wipers will be reduced by foreign substances on the windshield and wiper blades. If the wiper blades are not wiping properly, clean the windshield glass and the blades with a good quality mild detergent and rinse thoroughly with water. Repeat the above procedures if necessary.

Stains of silicone resin on the glass cannot be removed. Therefore, do not apply window polisher containing silicone resin to the windshield glass.

Otherwise stripes will appear on the glass and the driver's vision will be affected.

Do not use solvents, gasoline, kerosene or paint thinners to wash the wipers. These substances are corrosive and could damage the wipers and painted surfaces.

Caution

Do not run the wiper blades on dry/dusty glass, always spray water from windshield nozzle before switching on wipers.

The effectiveness of wipers will be reduced by foreign substances on the windshield and wiper blades such as tree leaves, dust, sand, bird droppings etc. Clean the glass to remove foreign substances before using wipers.

Replacing Wiper Blades

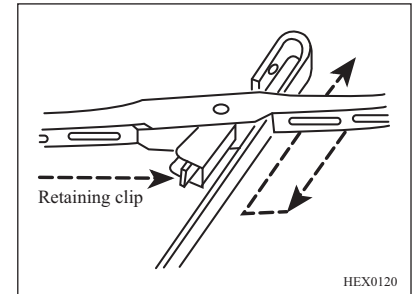

1. Press and hold the blade retaining clip.
2. Remove the wiper blade from the wiper arm.
3. Fit a new wiper blade onto the wiper arm.

AIR FILTER

Inspect and replace the filter regularly according to the maintenance schedule in this Manual.

Caution

The engine needs clean air to operate properly.

Do not operate your vehicle without the air cleaner element installed.

Driving without the air cleaner element properly installed can damage your engine.

Cleaning the Air Filter

If the air filter is too dirty, clean it by following steps:

1. Lightly tap and shake the air filter (away from the vehicle) to release loose dust and dirt.
2. Inspect the air filter for any damage and replace it if damage is found.
3. Clean the inside of the housing.
4. Cover the housing with a damp cloth while cleaning the filter.

Note

Do not clean the engine air filter with water or compressed air.

DRIVE BELT

In order for the alternator, power steering pump and air conditioning compressor to function properly, the drive belt should be in good condition and should be adjusted properly.

Replace the drive belt if it is worn, cracked, or frayed.

Caution

The engine could be started unexpectedly if the key is left in the ignition.

Do not leave the key in the ignition while checking the drive belt.

Moving engine parts can cause serious injuries while the engine is running.

BATTERY

Your vehicle is equipped with a battery that requires no periodic maintenance.

Caution

Batteries contain acid that can burn you badly, cause explosions and damage painted surfaces.

Do not let battery fluid touch your skin or clothing.

Keep the battery away from flames, sparks and smoking materials.

Cleaning Battery Terminals

1. Turn off the ignition and remove the key.
2. Use a wrench to loosen and remove the battery cable clamps from the terminals. Always disconnect the battery negative (-) terminal first.
3. Use a wire brush or a terminal cleaning tool to clean the terminals.

4. Check the battery terminals for white or bluish powder which is a sign of corrosion.
5. Remove any corrosion with a solution of baking soda and water. The solution will bubble and turn brown.
6. When the bubbling stops, wash the solution off with plain water and dry the battery with a cloth or paper towel.
7. Reconnect and tighten the positive (+) terminal, then the negative (-) terminal. Always reconnect the negative terminal (-) last.
8. Coat the terminals with petroleum jelly to prevent corrosion.

Note

Always reconnect the positive (+) terminal first; always disconnect the negative (-) terminal first.

Caution
<p>When reconnecting the cable to the battery, be careful to ensure the clamps are fully seated, and then tighten the retaining bolts so the clamps will not vibrate loose.</p> <p>Attach the red cable to the positive (+) battery terminal and the black cable to the negative (-) battery terminal.</p> <p>Connecting the battery cables to the wrong terminals can result in injury and damage to the vehicle and other property.</p>

Caution
<p>Batteries contain toxic materials. Used batteries are detrimental to health and environment</p> <p>Batteries do not belong in household waste. They must be disposed off at an appropriate recycling collection point.</p>

Battery Maintenance

To extend the life of your vehicle battery, do the following:

- Keep the battery mounted securely.
- Keep the top of the battery clean and dry.
- Keep the terminals and connections clean, tight and coated with petroleum jelly.
- Immediately rinse off any spilt electrolyte using a solution of water and baking soda.
- If the vehicle is not going to be driven for an extended period of time, disconnect the cable from the negative (-) terminal of the battery.
- Charge the disconnected battery every six weeks.

Note

Remove battery from vehicle while charging & refilling.

⚠ Warning

Keep smoking materials away from the battery to avoid flames or sparks when the battery is checked because the explosive gas could be occurred.

If the battery explodes, it can be result in damages of your vehicle and serious injury or death.

Avoid skin contact with battery acid because it can damage by contained highly corrosive and toxic sulfuric acid.

If you accidentally get it on your skin, flush the place with water and get medical help immediately.

Keep batteries out of the reach of children because it contains sulfuric acid and gas.

Do not allow battery acid to contact your skin, eyes, clothing or paint.

Do not open and tilt the battery.

BRAKE PEDAL

Checking the Brake Pedal Free Play

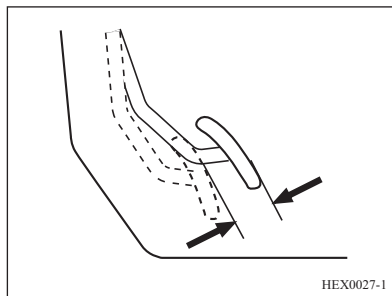

Brake pedal free play: 1-8 mm

1. Switch off the engine.
2. Press the brake pedal several times to eliminate the vacuum in the brake system.
3. Press the brake pedal by hand and measure the distance the pedal moves until there is a slight resistance.
4. If the brake pedal free play differs from the specification in this Manual, consult your CHEVROLET retailer to adjust the brakes.

PARKING BRAKE

Checking the Parking Brake Travel

Parking brake travel:

The parking brake lever travel must be 6 notches, with a force of approximately 150-170 N.

Check the parking brake travel by the following steps:

1. Switch off the engine.
2. Apply the parking brake and count the notch clicks. If the number of clicks or the force you feel you are applying differs from the above specification, consult your CHEVROLET retailer to adjust the parking brake.

FUSES

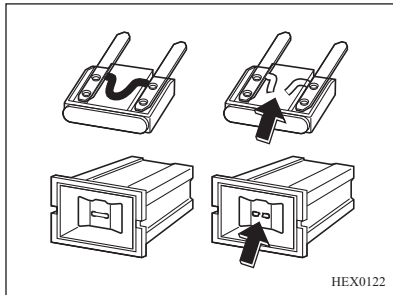

Replacing a fuse:

1. Open the fuse block cover.
2. Identify a defective fuse by its melted wire.
3. Use the fuse extractor to remove the blown fuse. The fuse extractor is located in the engine compartment fuse block.

Caution

Do not use a tool that can conduct electricity when removing a blown fuse. Only use a fuse extractor.

Using a conductor such as metal can cause a short circuit, damage the electrical system or start a fire. Serious injury could occur.

4. Identify the reason for the fuse blowing and solve the problem.
5. Replace the fuse with a new one of the correct rating. See the layout of fuse blocks later in this section.

Caution

Using a fuse substitute or a fuse of the wrong type or rating can damage the electrical system or even start a fire.

Be sure to use fuses of the correct size and rating. Otherwise personal injuries and damage to your vehicle and other property could be caused.

Fuse Blocks

Passenger compartment fuse block

- The passenger compartment fuse block is located behind the storage box on the right side of the instrument panel, and is visible after removal of the storage box.

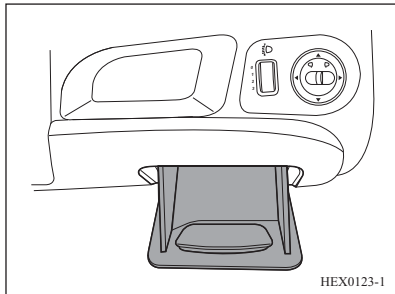

Engine compartment fuse block

- The engine compartment fuse block is located next to the coolant reservoir.

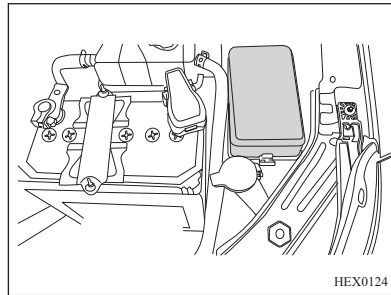

Caution

Spilling liquid on any electrical component on the vehicle may damage it. Always keep the covers on any electrical component.

Passenger Compartment Fuse Block

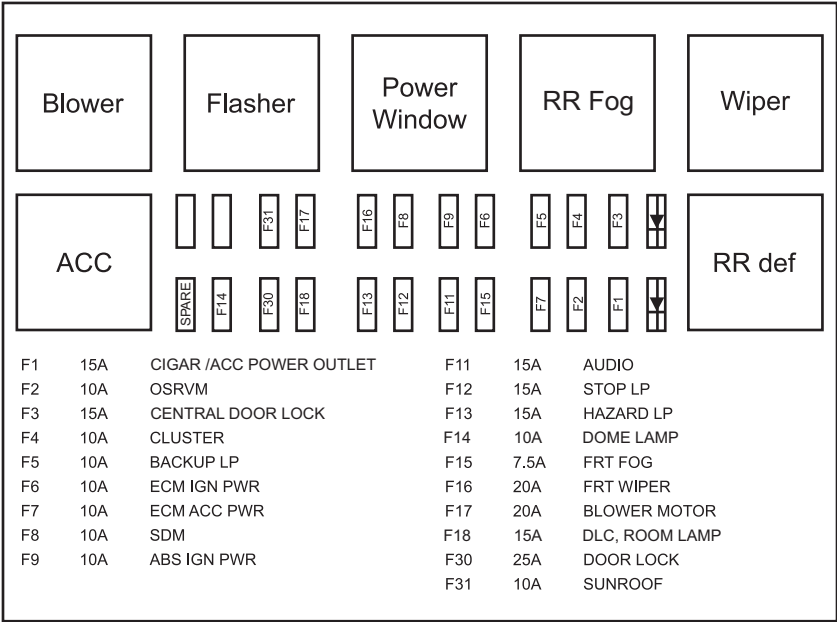

Engine Compartment Fuse Block

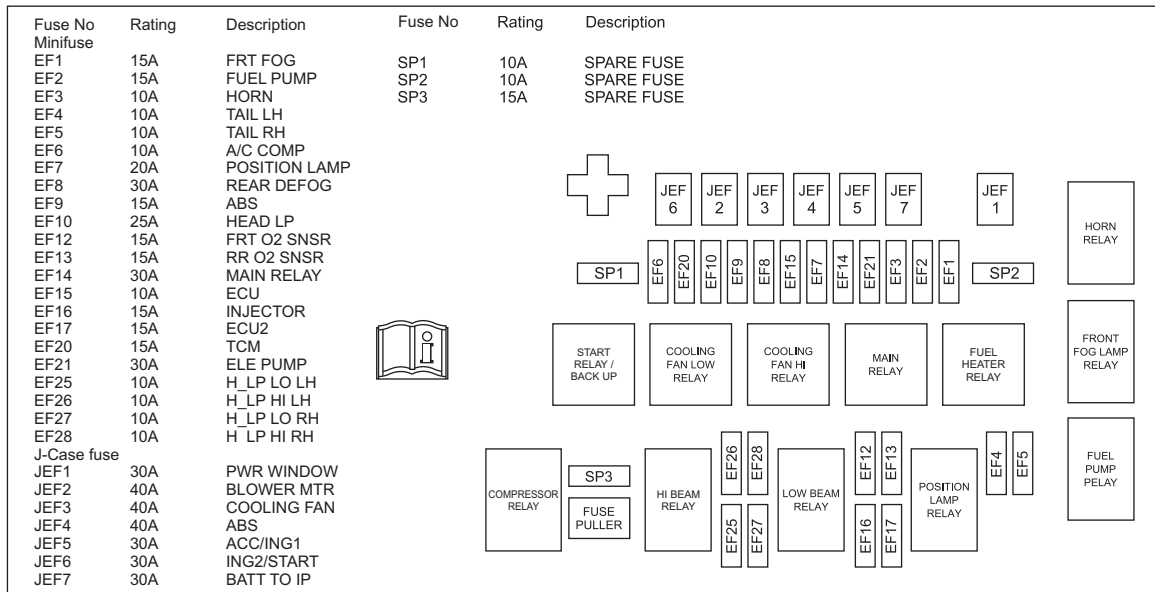

BULB REPLACEMENT

Caution

Halogen bulbs contain pressurized gas. Always handle halogen bulbs with care and dispose off them properly.

- Wear eye protection during handling of bulb.
- Protect the bulb to avoid abrasion and scratches.
- When the bulb is illuminated and not in a sealed installation, protect it from contact with liquids.
- Only illuminate the bulb when it is installed in a lamp.
- Replace any headlight that is cracked or damaged.
- Do not touch the glass shell of replaced bulb with your fingers or hands.
- Keep the bulbs away from children.
- Dispose off used bulbs with care. Otherwise the bulbs can explode.

Headlights

Bulb replacement

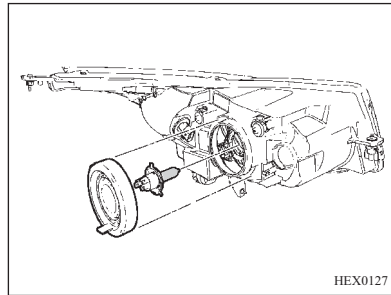

1. Open the hood.
2. Disconnect the wiring harness connector from behind the bulb.
3. Turn and remove the upper end of the windshield washer reservoir. (Only for the bulb on the left-hand side.)
4. Remove the headlight cap.
5. Release the spring that retains the bulb.
6. Remove the bulb.

7. Install a replacement bulb of the same rating.

See Bulb Specifications on page 126.

8. Reinstall the bulb retaining spring.
9. Refit the headlight cap.
10. Turn and reinstall the upper end of the windshield washer reservoir (Only for the bulb on the left-hand side.)
11. Connect the wiring harness connector.

Caution

Clean halogen bulbs with alcohol or mineral spirits and a non-woven cloth. Be sure not to touch the bulbs with your bare hands.

Fingerprints on a halogen bulb can drastically shorten the bulb's effective life.

Parking Lights

Bulb replacement

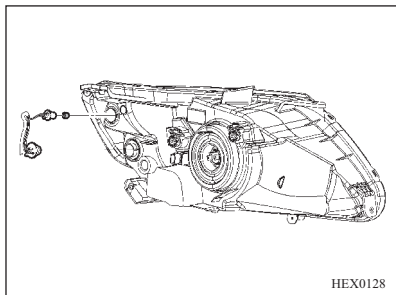

1. Open the hood.
2. Remove the wheel arch panel, and then remove the front bumper.
3. Remove the headlight assembly.
4. Turn the front parking light bulb socket counterclockwise.
5. Pull the parking light bulb socket out of the light housing.
6. Pull the bulb straight out of the socket.

7. Install a new bulb into the socket. See Bulb Specifications on page 126.
8. Turn the bulb socket clockwise to refit inside the light housing.
9. Reinstall the headlight assembly.

As removal of other parts is required (such as the front bumper and wheel house panel), it is recommended to have the bulb replaced at your CHEVROLET retailer.

Front Turn Signal Lights

Bulb replacement

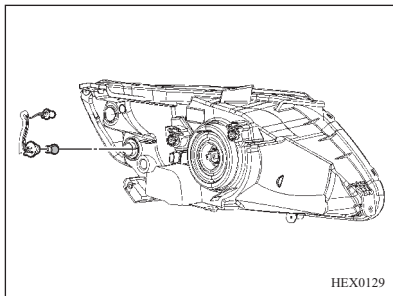

1. Open the hood.
2. Remove the wheel arch panel, and then remove the front bumper.
3. Remove the headlight assembly.
4. Turn the front turn signal light bulb socket counterclockwise.
5. Pull the front turn signal light bulb socket out of the light housing.
6. Pull the bulb straight out of the socket.
7. Install a new bulb into the socket. See Bulb Specifications on page 126.
8. Turn the bulb socket clockwise to refit inside the light housing.
9. Reinstall the headlight assembly.

As removal of other parts is required (such as the front bumper and wheel house panel), it is recommended to have the bulb replaced at your CHEVROLET retailer.

Front Fog Lights*

Caution

This service requires special equipment.

If you are not confident you can complete it safely, you must have this job done by your CHEVROLET retailer.

Otherwise personal injuries or damage to your vehicle could be caused.

Warning

The same rating of the bulb to be used during replacement and any usage of higher wattage bulbs can cause thermal issues such as melting of lamp housing and its surrounding parts. Warranty would be void if higher wattage bulbs are being used.

Side Turn Signal Lights

Bulb replacement

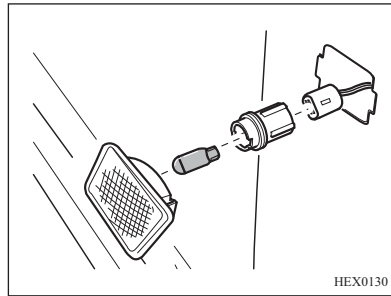

1. Remove the wheel arch panel.
2. Turn the bulb socket counter clockwise to remove it. (Both the bulb and the socket are connected to the vehicle wiring harness.)
3. Pull the bulb straight out of the socket.
4. Install a replacement bulb of the same rating.
5. Insert the socket into the lamp and turn it clockwise.
6. Refit the wheel arch panel.

Reverse Lights, Tail Lights, Stoplights and Rear Turn Signal Lights

Bulb replacement

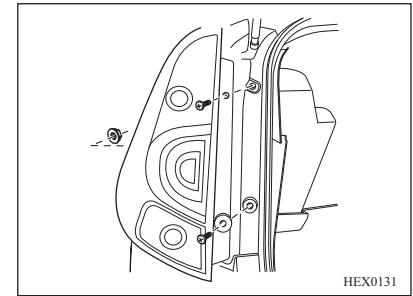

1. Open the tailgate, remove the tailgate trim panel next to the lights.
2. Remove one tail light nut in the tailgate trim panel and two tail light screws next to the tailgate, and remove the tail light assembly.
3. Turn the bulb socket counter clockwise to remove it.

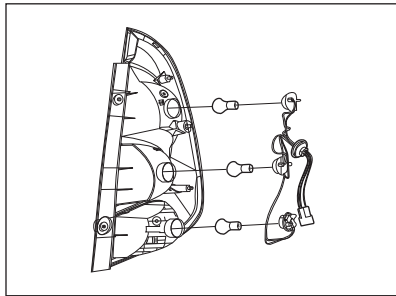

4. Push in and turn the bulb counter-clockwise to remove it from the socket.
5. Install a replacement bulb of the same rating. See Bulb Specifications on page 126.
6. Refit the socket in the light housing. Turn the socket clockwise to secure it.
7. Reinstall the light assembly and tighten one nut and two screws.

Central High-Mounted Stoplight

Bulb replacement

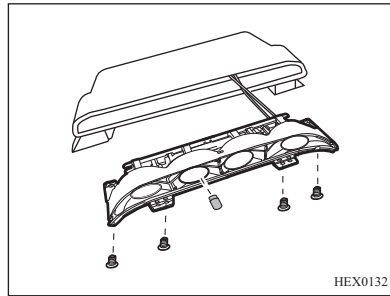

1. Remove two retaining screws, pull out the wiring harness plug and remove the high-mounted stoplight assembly.
2. Pry the lens, remove two screws and then remove the bulb socket.
3. Pull the bulb base out of the bulb socket.
4. Pull the bulb straight out of the socket.
5. Install a new bulb. See Bulb Specifications on page 126.

6. Reinstall the socket.
7. Reinstall the bulb socket into light assembly to secure it.
8. Connect the wiring harness plug and refit the light assembly.

License-Plate Light

Bulb replacement

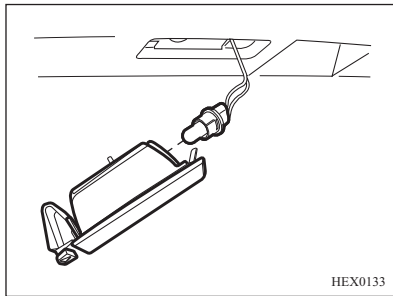

1. Remove the license-plate light assembly directly with your hands.
2. Turn the bulb socket counterclockwise to remove it from the housing.
3. Pull the bulb out of the socket.
4. Replace the bulb. See Bulb Specifications on page 126.
5. Turn the bulb socket clockwise to re-fit inside the light housing.
6. Reinstall the license-plate light assembly.

Dome Light

Bulb replacement

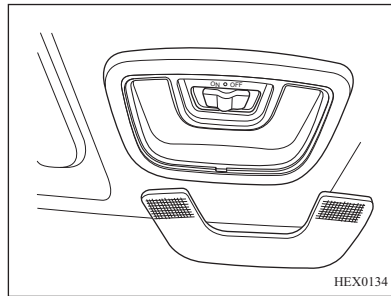

1. Use the flat edge of a screwdriver to pry the lens away from the headliner.
2. Remove the bulb.
3. Replace the bulb. See Bulb Specifications on page 126.
4. Reinstall the lens.

Rear Cargo Area Light*

Bulb replacement

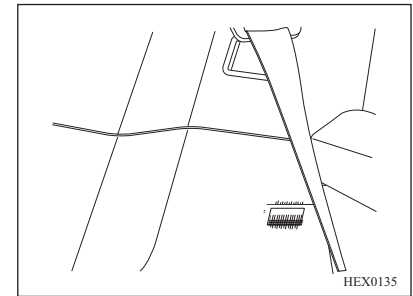

1. Use the flat edge of a screwdriver to pry the light assembly from the housing.
2. Replace the bulb. See Bulb Specifications on page 126.
3. Reinstall the light assembly.

Bulb Specifications

	Bulb		Power rating x Quantity	Note
Front	1	Headlights (high/low)	60/55W x 2	H4 60/55W
	2	Parking lights	5W x 2	W5W
	3	Turn signal lights	21W x 2	WY21W
	4	Fog lights*	35W x 2	H8 35W
	5	Side turn signal lights	5W x 2	WY5W
Rear	6	Tail lights/Stop lights	21/5W x 2	P21/5W
	7	Reverse lights	21W x 2	P21W
	8	Turn signal lights	21W x 2	PY21W
	9	License-plate lights	5W x 2	W5W
	10	High-mounted stoplight	5W x 4	W5W
Interior	11	Dome light	10W x 1	12V10W
	12	Rear cargo area light*	10W x 1	12V10W

Bulb specifications in some models can be different from the above table. See the wattage printed on the bulb before replacing burnt bulbs.

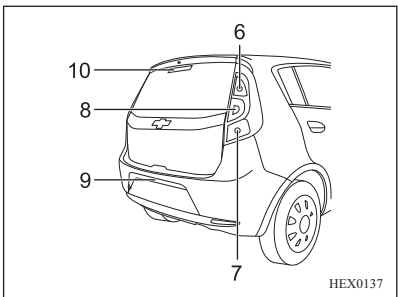
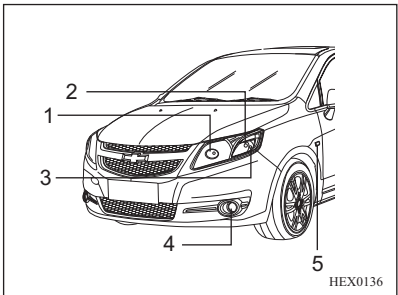

⚠ Warning

The same rating of the bulb to be used during replacement and any usage of higher wattage bulbs can cause thermal issues such as melting of lamp housing and its surrounding parts. Warranty would be void if higher wattage bulbs are being used.

WHEELS AND TIRES

The original tires are suitable for your vehicle, delivering optimum riding comfort, tread life and performance.

Caution

Using non-recommended tires and /or wheels can cause a collision.

Before attempting to change your original tires or wheels, consult your CHEVROLET retailer.

Otherwise personal injury and damage to your vehicle and other property could be caused.

Maintenance

Caution

Do not overload the vehicle.

Always maintain proper tire pressures.

Tire pressures must be checked when the tires are cold (at ambient temperature).

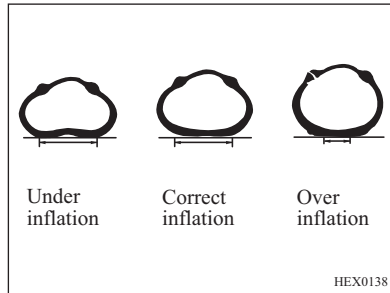

The tire pressure should comply with the specifications in this Manual to ensure optimal ride comfort, safety and performance. The tire pressure label is on the driver's door frame.

Use a calibrated tire pressure gauge to check the tire pressure when the tires are cold. Tighten the valve caps after checking.

Caution

Tire pressure should be checked when the tires are cold.

The readings will not be correct when the tires are warm. Tires become warm after driving for 1.6 km and will not cool down within 3 hours.

Check the tire pressure each time when you are refueling or at least once a month. Incorrect tire pressure will :

- Accelerate tire wear.
- Affect the vehicle's driveability and safe operation.
- Affect ride comfort.
- Reduce fuel economy.

If the tire pressure is too low, the tires can become overheated, causing internal damage and tread separation or even a flat tire at a high speed. Even if the tire pressure is adjusted later on, the tires might have already been damaged by low pressure driving.

Maintenance of tires and wheels

Driving over sharp objects can damage the tires and wheels. If driving over a sharp object is unavoidable, drive over it slowly, and at a right angle if possible.

When parking, avoid bringing your tires into contact with the curb.

Check the tires regularly for

- External damage.
- Foreign objects.
- Punctures.
- Cuts.
- Cracks.
- Side wall bumps.

Check the wheels for damage.

Tire defects including the above defects can cause you to lose control while driving and lead to personal injuries.

If your tires or wheels have been damaged or abnormal wear is detected, consult your CHEVROLET retailer. Your vehicle is equipped with radial tires. General Motors suggests you to use a tire of the same size, pattern, tread wear, temperature and speed rating for replacement.

Caution

Using a tire of a size different from the original tires can cause interference between the tire and vehicle parts, resulting in damage to the tire and vehicle.

Integrated Tread Wear Indicator

Regularly check the tread groove depth by the integrated tread wear indicator. The position of tread wear indicator is indicated by a mark on the tire wall.

Caution

Do not drive with a worn or damaged tire.

A worn or damaged tire can make you lose control of the vehicle and cause a collision, resulting in personal injuries or damage to your vehicle or other property.

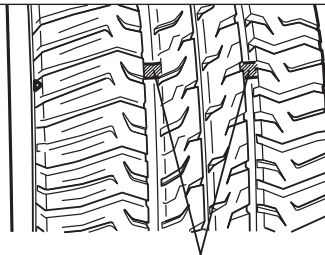

Tread wear indicators (TWI) HEX0139

The tire must be replaced when the tread wear indicator appears. It will appear between the tread grooves when the tire has 1.6 mm or less of tread left.

Note

Always dispose of worn tires according to the local environmental regulations.

Tire Rotation

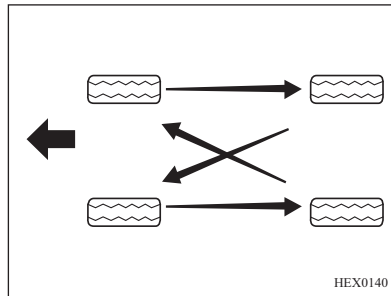

Front tires and rear tires have different working conditions, and therefore they wear out at different rates.

Normally, the front tires will wear faster than rear tires. To make your tires last longer and to avoid uneven tread wear:

1. Have the tires rotated according to the maintenance schedule in the Manual.
2. Maintain a proper tire pressure.
3. Inspect the tightness of wheel nuts.

Caution

Always use the recommended wheels and recommended wheel nuts.

Otherwise you could lose control of the vehicle and cause a collision, resulting in personal injury or damage to your vehicle or other property.

Winter Tires

If you decide to use winter tires:

- Use them on all four wheels.
- Never exceed the top speed specified by the tire manufacturer.
- Always maintain the specified tire pressure.

Do not use your spare wheel on other vehicles. Do not mix your spare tire or wheel with the wheels or tires of other vehicles; they are not compatible. Keep your spare tire together with its wheel.

Caution

Do not use tire chains on your spare wheel. They are not suitable for your spare wheel.

Using tire chains can damage your vehicle and the chains.

Spare Wheel, Jack and Tools

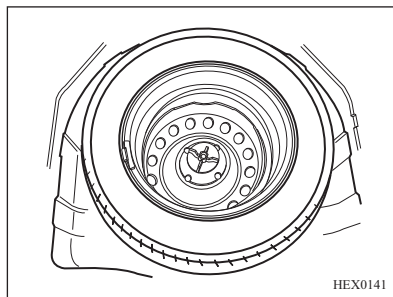

The spare wheel, jack and tools are stored under the carpet in the rear compartment.

The spare wheel is secured by retaining nuts.

Spare wheel

The spare wheel has a steel rim. Using a spare tire smaller than other tires can affect driving performance. Please note the precautions on the spare tire labeling where applicable. Replace the defective tire as soon as possible.

Changing a wheel

Observe the following instructions when changing a wheel:

- Never position yourself below a vehicle when it is supported by a jack.
- Never let the engine continue to run or start the engine while changing a wheel.
- Only use the jack when changing a wheel.

Changing a wheel:

1. Park the vehicle on a level and solid surface, if possible.
2. Turn on the hazard warning flashers and apply the parking brake.
3. Place the gear shift in the first or reverse gear.
4. Place the warning triangle at an appropriate position behind the vehicle.
5. Use wood blocks or stones to block the wheel diagonally opposite to the tire to be changed.

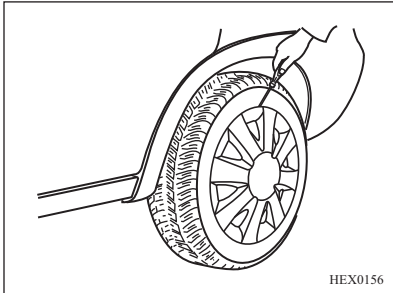

6. Use a screwdriver to remove the wheel cover (if equipped).

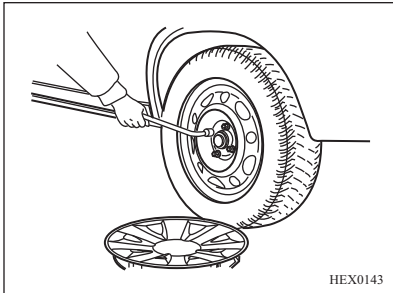

7. Use the wheel wrench to loosen the wheel nuts by a half to one turn each. Do not loosen them completely.

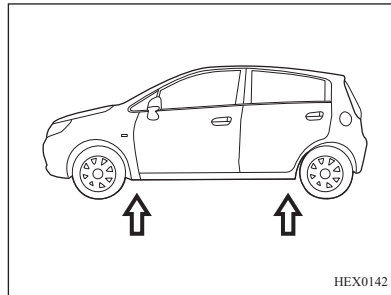

8. Insert the jack into the position indicated by the arrows (where there is a half circle notch).

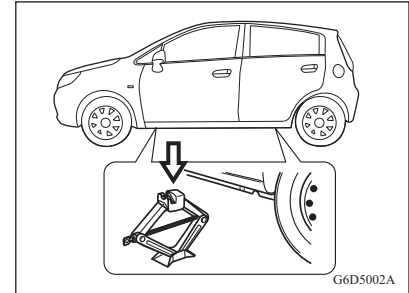

9. The jack should be placed at a jacking point nearest to the tire you want to change. The jack lift head (indicated by the arrow) should be placed around the vertical lugs and inserted into the notch of the lugs.

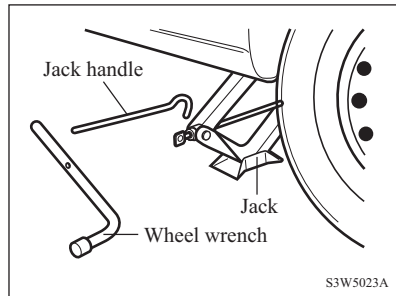

10. When rotating the jack handle, make sure the jack base is in contact with ground and directly under the notch on the lugs.
11. Slowly rotate the jack handle to raise the vehicle.
12. Completely loosen the wheel nuts.
13. Change the wheel.
14. Reinstall the wheel nuts and tighten slightly.
15. Lower the vehicle.

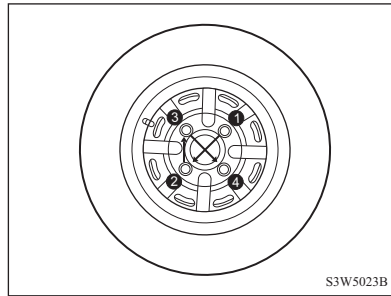

16. Tighten the wheel nuts to 130 Nm, in a diagonal pattern.
17. Store the flat tire in the rear compartment together with the tools and jack that are properly packaged.
18. Have the tire fixed as soon as you can. Reinstall it on the vehicle after balancing.

Tool packing steps

1. Place the wheel wrench and jack handle into the specified position.
2. Put the jack into the tool bag, facing upward.
3. Bundle up the tool bag tightly.
4. Store the tool bag in the spare wheel compartment. Place it in front-rear direction.
5. Store the tow hook in a cover* provided on rear carpet.

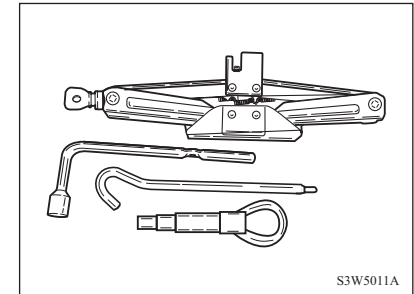

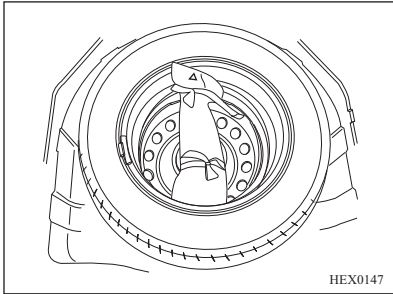

After the tool bag is packed, place the warning triangle properly according to the picture. Warning triangle is provided at the time of vehicle delivery.

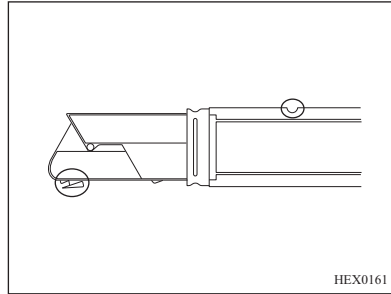

JUMP STARTING THE ENGINE

Caution

Do not try to start your vehicle by pushing or pulling it.

Otherwise it could cause damage to the catalytic converter and transmission, and result in personal injury.

You can start vehicle that has a discharged battery by transferring electrical power to it from a battery in another vehicle.

Caution

Batteries entail a risk of explosion. You may be burned by the acid in batteries and a short circuit can lead to personal injury and vehicle damage.

Keep batteries away from flames or sparks.

Do not lean over the battery while jump starting.

Do not let the cable terminals touch each other.

Wear eye protection when working near any battery.

Do not let battery fluid touch eyes, skin, fabrics or painted surface.

Make sure the battery providing the jump start has the same voltage as the battery receiving the jump.

Caution (continued)

Do not disconnect the discharged battery from the vehicle.

Failure to observe the above warnings or the instructions below could result in battery explosion, acid burning or short circuit.

The electric systems of both vehicles could be damaged and serious injuries could occur.

Preparation before jump starting

1. Apply the parking brake firmly.
2. Shift the transmission into neutral.
3. Turn off all electrical accessories.

Caution

Turn off the audio system before jump starting. Otherwise it could be damaged.

Caution

When connecting the cable, make sure it is not near any engine parts that will move.

Otherwise, you could be injured or your vehicle could be damaged.

Connecting the jumper cables

While jump starting, connect the jumper cables in the following sequence:

1. Connect one end of the first jumper cable to the positive terminal on the charged battery.
(There is a "+" mark on the battery housing or the terminal.)
2. Clip the other end of the jumper cable onto the positive terminal on the discharged battery. (There is a "+" mark on the battery terminal.)
3. Connect one end of the second jumper cable to the negative terminal on the charged battery.

(There is a "-" mark on the battery housing or the terminal.)

Caution

Do not connect the negative terminal when finally connecting to the vehicle you want to charge.

In final connection, attach the clip to the steel frame bolted to the engine block.

The final connection point should be as far away from the battery as possible.

If you connect the jumper cable to the negative terminal on the dead battery, it can cause arcs or even battery explosion.

Serious personal injury or vehicle damage can result.

4. Turn off the electrical devices on the vehicle as possible (e.g. lights, blower, audio system), start and run

the discharged vehicle for 20 minutes. This can recharge the battery.

5. During jump starting, the engine on the vehicle providing the jump starting can be allowed to run.

Caution

Attempts to start the engine of the vehicle with the discharged battery should be made at intervals of about one minute and should not last longer than 15 seconds each.

After the vehicle with discharged battery starts:

1. Take care to disconnect the grounding terminal (-).

Disconnect from the vehicle with discharged battery first. Keep the engine running on the vehicle with discharged battery.

2. Disconnect the negative cable from the vehicle providing the jump start.
3. Disconnect the positive cable from the two batteries. Store the jumper cables where the spare wheel is stored.
4. Turn off the electrical devices on the vehicle as possible (e.g. lights, blowers, audio system), and drive the discharged vehicle for 20 minutes. This can recharge the battery.
5. If discharging reoccurs, consult your CHEVROLET retailer.

TOWING THE VEHICLE

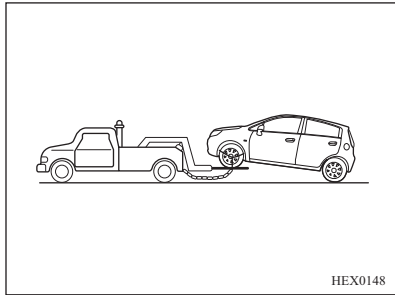

If vehicle towing is needed, contact your CHEVROLET retailer or a professional towing service.

Caution

Never let passengers ride in a vehicle that is being towed.

Do not tow faster than safe speeds or road speed limits.

Never tow a vehicle by any components that are damaged and not fully secured on the vehicle.

Failure to observe the above warnings could result in injuries.

Towing your vehicle with a wheel lift

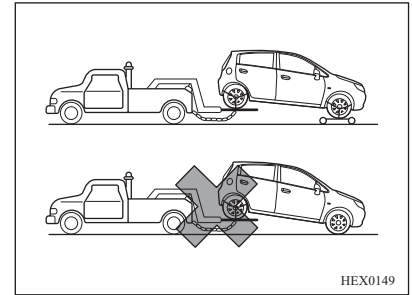

1. Turn on the hazard warning flashers.
2. Turn the ignition key to the ACC/ACCESSORY position.
3. Shift the transmission into Neutral.
4. Release the parking brake.

Caution

If your vehicle must be towed from the rear, use a towing dolly under the front wheels.

Do not have your vehicle towed from the rear with the front wheels touching the ground.

Otherwise, the transmission could be badly damaged.

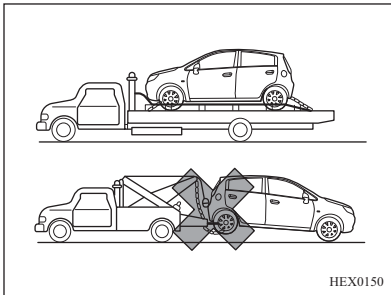

5. Tow your vehicle with the front wheels off the ground.

Caution

Do not tow with a sling-type equipment.

Only use wheel-lift or vehicle carrier equipment.

Emergency Towing

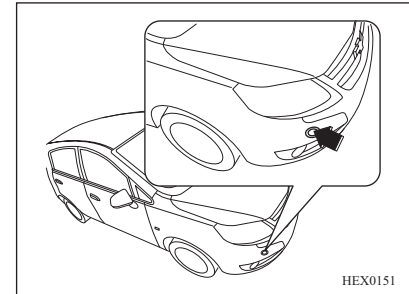

If towing service is not available in an emergency, the vehicle may be towed temporarily by securing a cable to the front hook under the vehicle. When the front hook is used in towing, you can only use a tow rope, not a rigid towing bar.

Front Towing Hook

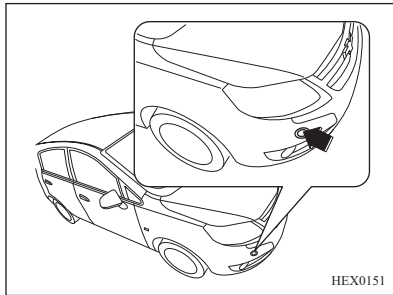

There is a round cover at the right hand side of the front bumper. A fixing hole for hook installation can be found after you open the cover by pressing it on the driver side, as indicated by the arrow in above diagram. The hook is stored in the tool bag in the rear compartment.

Install the hook on the fixing hole, turn it clockwise to tighten firmly. Tow the vehicle after ensuring that the hook is securely attached. While towing, a driver must be in the vehicle to steer it and operate the brakes. After towing, remove the hook and close it with the cover. Insert the cover into the hole by pushing it towards the driver side, and then press the passenger side to firmly close it.

Caution

When towing the vehicle with a tow rope, the vehicle can be damaged.

To reduce damage:

Use the towing hook only if no other towing equipment is available.

Only tow the vehicle from the front.

Keep the tow rope clear of the bumper.

Pull on the tow rope to make sure it is securely fixed to the towing hooks at both ends.

Drive off slowly and avoid sharp turns.

Caution

When towing with a tow rope, you could lose control of the towed vehicle.

Only tow at a low speed for a short distance.

Do not tow the vehicle if the wheels, transmission, axles, steering or brakes are damaged.

Do not remove the key from the ignition switch, otherwise the steering will lock, making the vehicle undrivable.

Towing Hook for Shipping

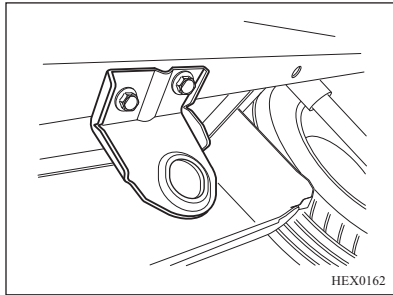

The towing hook for shipping is located below the left part of the rear bumper on the vehicle body floor, and is used when this vehicle is shipped.

Caution

Do not use this towing hook to tow other vehicle, otherwise your vehicle will be damaged.

In order to keep its optimum performance, it is not recommended to use this vehicle to tow other vehicles.

ROCKING YOUR VEHICLE

Take the following steps to free your vehicle when it is stuck in snow, mud or other soft surfaces.

1. Turn the steering wheel all the way to the left and then all the way to the right, to clear the area around the front wheels.
2. Shift the transmission back and forth between reverse and a forward gear.
3. Spin the wheels as little as possible.
4. Release the accelerator pedal while you shift.
5. Press the accelerator pedal lightly when in gear.

If the vehicle is not freed after several attempts, the vehicle needs to be towed out. Contact CHEVROLET retailer to seek assistance.

Caution

If your vehicle gets stuck in sand, mud or snow, you will need to rock your vehicle out.

Before rocking the vehicle, check that there are no physical objects or people around the vehicle.

The vehicle could move forward or back suddenly. The people around it could be injured and objects could be damaged.

Caution

The following warnings must be observed to prevent damage to the transmission and other parts:

Do not press the accelerator pedal while shifting or before the transmission is shifted into forward or reverse gear.

Do not let the engine run at too high speed and avoid spinning the wheels.

VEHICLE MAINTENANCE

Cleaners

Always comply with the recommendations of manufacturer when using cleaners or other chemicals for the interior or exterior of the vehicle.

Caution

Some cleaners are toxic, corrosive or flammable.

Improper use is very dangerous and could result in personal injury or vehicle damage.

Do not use hazardous cleaners when cleaning the interior or exterior of the vehicle. For instance:

- Acetone.
- Paint thinners.
- Enamel reducer.
- Nail polish remover.

Do not use the following cleaners when cleaning the interior and exterior of the vehicle, unless otherwise specified in the stain removal instructions for fabric or leatherette cleaning:

- Laundry soap.
- Bleach.
- Reducer.

Do not use the following materials for cleaning:

- Carbon tetrachloride.
- Gasoline.
- Benzene.
- Naphtha.

Caution

Avoid prolonged exposure to vapors of cleaners and other chemicals.

These vapors are hazardous and harmful to health, especially in restricted and poorly ventilated spaces.

Open the doors for proper ventilation when using cleaners or other chemicals for interior of the vehicle.

Caution

Do not let color-fading fabrics come into contact with the vehicle interior trims, unless both materials are completely dry.

In order to prevent potential permanent discoloration of light coloured interior trims, do not let color-fading fabrics come into contact with the seat cover, unless both materials are completely dry.

The following is a short list of colour-fading fabrics:

- Casual wear
- Dyed denim
- Corduroy
- Leather

- Suede
- Newspaper
- Decorative paper

Interior Maintenance and Cleaning

Caution

Always use proper cleaning methods and materials to clean the interior trims.

Otherwise water stains, water marks and permanent stains could result, especially during first time cleaning.

These materials can cause permanent damage to the vehicle.

Always use proper cleaning methods and materials to clean the interior and exterior of the vehicle.

Use a vacuum cleaner or a soft brush to remove the dust and dirt accumulated on the fabrics inside the vehicle.

Use a clean, wet cloth to clean the vinyl plastic and leather trims regularly.

Use proper cleaners to clean the dusts, blemishes or stains on the trims.

Maintenance of Safety Belts

Caution

The safety belts must be kept in good working order to maintain their normal function.

Keep the safety belts clean and dry. Prevent the safety belts from being contaminated by polishes, oil or chemicals, especially battery electrolytic solution, bleach and dye.

These contaminants can reduce the strength of the safety belt materials.

Perform regular inspection on all parts of the safety belts. Immediately replace any damaged safety belts or parts thereof.

Safety belts stretched in an accident and the associated parts must be replaced, even if the damage is not obvious or invisible. The safety belts used for replacement must be new.

It is recommended by General Motors to replace the whole safety belt

assembly after a collision. The safety belts may not have to be replaced if your CHEVROLET retailer finds that the safety belts are not damaged and work properly.

Glass Surface

Caution

Abrasive cleaners can scratch the glass and damage the rear window defroster grid.

Do not use abrasive cleaners on the rear window glass.

Otherwise the driver's vision will be affected.

Keeping the window glass clean can help to reduce dazzling and improve vision.

Caution

Stickers can affect the rear window defroster.

Do not put stickers on the inside of the rear window.

Otherwise the driver's vision will be affected.

Cleaning the outside of the windshield

Wax or other substances on the windshield and on wiper blades can cause blade vibration during operation. Also these foreign substances will not help to keep the windshield clean.

Use non-abrasive cleaners to clean the outside of the windshield.

Water cannot form drops on the windshield when it is clean.

Exterior Maintenance and Cleaning

Washing the vehicle

The best way to maintain the surface paint is to wash the vehicle frequently and keep it clean.

- Park the vehicle in a place shielded from direct sunlight.
- Wash the vehicle with specified mild soap liquid and cold or warm water.
- The liquid soap and cleaners on the surface must be washed off.

Caution

Do not wash the vehicle with a domestic washing up agent. A domestic washing up agent can wash off the paint wax.

Caution

Avoid too high pressure when washing the vehicle.
The vehicle interior can be damaged if water penetrates in the vehicle.

The vehicles of General Motors are designed for operation under normal and natural conditions.

Caution

The antenna can be damaged by automatic vehicle washers.
Turn off the sound system and retract the antenna.
Remove the antenna rod or roof antenna.

Polishing and waxing

Regular polishing can remove the residual materials on the vehicle surface. High-quality automotive wax should be used after polishing for best protection.

Protecting the exterior polished metal parts

Regularly clean the polished metal trim parts. Usually, water cleaning will be sufficient.

Caution

Do not clean or polish the aluminum trim parts by using an automotive or chrome polish, steam or alkaline soap liquid.
These materials are abrasive and can damage the trim parts and wheels.

Do not forget to wax the polished metal parts when waxing the vehicle.

Cleaning the aluminum wheels and wheel trim covers

In order to maintain the original appearance of the wheels and wheel trim covers, do not let dirt or brake dust accumulate on them.

Caution

Do not use an abrasive cleaner or brush to clean the aluminum wheels or wheel trim covers.

Clean the wheels / wheel trim covers regularly. Do not use abrasive cleaners or brushes that can damage the surface paint.

Preventing Corrosion

The vehicles of General Motors are designed to have corrosion-resistant properties. Most parts are designed with special materials and protective paint to help maintain a good appearance, strength and reliability.

Although some parts in the engine compartment and underneath the vehicle may become rusty on surface, the reliability or functionality of these parts will not be affected.

Metal sheet damage

If the vehicle body needs to be repaired or replaced, make sure that the workshop uses proper anticorrosive materials to restore the corrosion-resistance properties.

Sediment of foreign substances

The following substances can damage the paint surface:

- Calcium chloride and other salts.

- De-icers.
- Bitumen and asphalt.
- Tree sap.
- Bird excrement.
- Industrial dust.

Wash detrimental materials off the vehicle promptly. If the residual materials cannot be removed by soap liquid, special cleaners can be used.

Caution

Only use safe cleaners that are not detrimental to the painted surface. Other cleaners can permanently damage the paint.

Surface paint damage

Repair scrapes, cracks or deep scratches as soon as possible.

Exposed metal corrodes easily. Minor cracks and scratches can be repaired by using fast-drying products.

Large-area repairs can be performed at a body and paint workshop.

Underbody maintenance

Corrosive materials can collect on the underbody of your vehicle. Failure to remove these materials can accelerate corrosion and rust.

Regularly wash the underbody with plain water. Take care to clean the parts where dirt can accumulate easily. Loosen the dirt in enclosed areas before washing.

When necessary, have this service provided by your CHEVROLET retailer.

Caution

When you wash the engine compartment, fuel, lubricants and oil sediment can be flushed into the environment.

Only wash the engine at your CHEVROLET retailer or another place where the oil separation equipments are provided.

Dispose of used engine oil, brake/clutch fluid, transmission fluid, anti-freeze, batteries and tires at a waste disposal facility specified by the local laws, or have them disposed of by the sellers who have supplied these materials and have a legal obligation to dispose of them properly.

Do not mix these materials with the household waste or discharge them into the drains.

These hazardous materials can permanently damage the environment if not disposed of properly.

**SERVICE AND MAINTENANCE
General Information**

Service Information

In order to ensure economical and safe vehicle operation and to maintain the value of your vehicle, it is of vital importance that all maintenance work is carried out at the proper intervals as specified.

Caution

Chevrolet recommends to consult authorized CHEVROLET retailer for instructions and vehicle health check-up before setting out a long journey.

Confirmations

Confirmation of service is recorded in the Service and Warranty Booklet.

The date and mileage is completed with the stamp and signature of the servicing CHEVROLET retailer.

Make sure that the Service and Warranty Booklet is completed correctly as continuous proof of service is essential if any warranty or goodwill claims are to be met, and is also a benefit when selling the vehicle.

146 Vehicle Maintenance

Scheduled Maintenance

Service Schedules

Maintenance service and record retention are the owner's responsibility. You should retain evidence that proper maintenance has been performed on your vehicle in accordance with the scheduled maintenance service chart.

For vehicles with normal annual mileage.

MAINTENANCE ITEM	Kilometers or time in months/years, whichever comes first											
	1 Month/1000	6 Months/5000	1 Year/10000	2 Years/20000	3 Years/30000	4 Years/40000	5 Years/50000	6 Years/60000	7 Years/70000	8 Years/80000	9 Years/90000	10 Years/100000
ENGINE CONTROL SYSTEM												
Drive Belts (Alternator, Power Steering and A/C Compressor)	I	I	I	I	I	I	I	I	I	I	I	I
Engine Oil and Engine Oil Filter (1) (3)	I	I	R	R	R	R	R	R	R	R	R	R
Cooling System and Hose Connections	I	I	I	I	I	I	I	I	I	I	I	I
Engine Coolant (3)	I	I	I	I	I	I	R	I	I	I	I	R
Fuel Filter	I	I	I	R	I	R	I	R	I	R	I	R
Fuel Line and Connections	I	I	I	I	I	I	I	I	I	I	I	I
Air Cleaner Element (2)	I	I	R	R	R	R	R	R	R	R	R	R
PCV System				I		I		I		I		I
EPV Filter (If Available)			I	R	I	R	I	R	I	R	I	R

Chart Symbols:

I- Inspect these items and their related parts. If necessary, correct, clean, replenish, adjust, rotate or replace.

R- Replace or change

- (1) If a vehicle is operated under severe conditions: short distance driving, extensive idling or driving in dusty conditions, change engine oil and the filter every 5,000 kms or 6 months, whichever comes first.
- (2) Inspect the air cleaner element every 5,000 kms or 6 months if vehicle is driven under dusty driving conditions. If necessary correct, clean or replace.
- (3) Refer to "Recommended Fluids and Lubricants" on page 152.

For vehicles with normal annual mileage.

MAINTENANCE ITEM	Kilometers or time in months/years, whichever comes first											
	1 Month/1000	6 Months/5000	1 Year/10000	2 Years/20000	3 Years/30000	4 Years/40000	5 Years/50000	6 Years/60000	7 Years/70000	8 Years/80000	9 Years/90000	10 Years/100000
CHASSIS AND BODY												
Exhaust Pipe & Mountings	I	I	I	I	I	I	I	I	I	I	I	I
Brake / Clutch Fluid (3) (4)	I	I	I	R	I	R	I	R	I	R	I	R
Front Brake Pads & Discs (5)	I	I	I	I	I	I	I	I	I	I	I	I
Rear Brake Drum & Linings (5)	I	I	I	I	I	I	I	I	I	I	I	I
Parking Brake	I	I	I	I	I	I	I	I	I	I	I	I
Brake Line & Connections (Including Booster)	I	I	I	I	I	I	I	I	I	I	I	I
Manual Transaxle Fluid : Leak Check (3)	I	I	I	I	I	I	I	I	I	I	I	I
Chassis & Underbody Bolts & Nuts Tight / Secure	I	I	I	I	I	I	I	I	I	I	I	I

Chart Symbols:

I- Inspect these items and their related parts. If necessary, correct, clean, replenish, adjust, rotate or replace.

R- Replace or change

(3) Refer to “Recommended Fluids and Lubricants” on page 152.

(4) Change the brake / clutch fluid every 10,000 kms or 1 years (whichever is earlier) if the vehicle is mainly driven under severe conditions:

- Driving in hilly or mountainous terrain, or
- Towing a trailer frequently.

(5) More frequent maintenance is required if under severe condition: frequent low-speed operation in stop-and go traffic or driving in dusty conditions.

148 Vehicle Maintenance

For vehicles with normal annual mileage.

MAINTENANCE ITEM	Kilometers or time in months/years, whichever comes first											
	1 Month/1000	6 Months/5000	1 Year/10000	2 Years/20000	3 Years/30000	4 Years/40000	5 Years/50000	6 Years/60000	7 Years/70000	8 Years/80000	9 Years/90000	10 Years/100000
CHASSIS AND BODY												
Tire Condition and Inflation Pressure	I	I	I	I	I	I	I	I	I	I	I	I
Wheel Alignment (6)	As and when required or as suggested by CHEVROLET retailer											
Wheel Balancing (6)	As and when required or as suggested by CHEVROLET retailer											
Steering Wheel & Linkage	I	I	I	I	I	I	I	I	I	I	I	I
Power Steering Fluid & Lines (3)	I	I	I	I	I	I	I	I	I	I	I	I
Drive Shaft Boots	I	I	I	I	I	I	I	I	I	I	I	I
Safety Belts, Buckles & Anchorages	I	I	I	I	I	I	I	I	I	I	I	I
Lubricate Locks, Hinges & Hood Latch	L	L	L	L	L	L	L	L	L	L	L	L
A/C Mesh Filter	I	I	I	I	I	I	I	I	I	I	I	I

Chart Symbols:

I- Inspect these items and their related parts. If necessary, correct, clean, replenish, adjust, rotate or replace.

R- Replace or change

L- Lubricate

(3) Refer to "Recommended Fluids and Lubricants" on page 152.

(6) If necessary, rotate and balance wheels.

(7) Tire condition should be inspected before driving and tire pressure should be checked each time you fill your fuel tank or at least once a month using a tire pressure gauge.

TECHNICAL DATA

Vehicle Identification 149
Vehicle Data 150
Capacities and Specifications 152

VEHICLE IDENTIFICATION

Vehicle Identification Number (VIN)

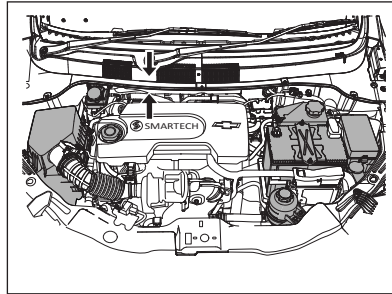

This number is the legal identifier for your vehicle.

The vehicle identification number is engraved on the top of the bulkhead.

VIN Plate Location

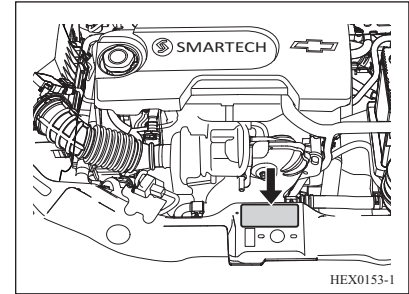

The vehicle identification number (VIN) plate is attached to the top of the front end upper panel.

VEHICLE DATA

Engine

Engine identifier code	10FCVZ
Type	4, Inline, 1-3-4-2, Diesel, TCDi
Bore x Stroke, mm	69.7 x 82
Number of cylinders	4
Piston displacement, cc	1248
Compression ratio	16.5 (± 0.5) : 1
Engine Power kW @ rpm	55.3 @ 4000
Torque Nm @ rpm	190 @ 1750 \pm 50
Battery rating (V-Ah)	12-65

Brakes

Service brake	Hydraulic, vacuum assisted, diagonal circuit with auto slack adjuster
Auto slack adjuster	Rear brakes
ABS	Optional
Front brakes	Disc
Rear brakes	Drum

Gear Box

Drive system	Front wheel drive
No. of gears	5 forward 1 reverse
Gear ratios	
1st	3.727
2nd	1.960
3rd	1.323
4th	0.946
5th	0.756
Reverse	3.633
Front axle ratio	3.737

Suspension

Front suspension type	McPherson strut
Rear suspension type	Twist axle

Shock Absorber

Front	Twin tube strut type (gas)
Rear	Twin tube shock absorbers type (gas)

Chassis

Type	Monocoque
------	-----------

Steering

Type	Hydraulic power assisted
------	--------------------------

Vehicle Dimensions

Overall length [mm]	3946
Overall width [mm]	1690
Overall height [mm]	1503
Wheel base [mm]	2465
Front wheel track [mm]	1462
Rear wheel track [mm]	1457
Ground clearance [mm]	168

Vehicle Weight

Kerb weight [kg]	1124
Gross vehicle weight [kg]	1519

Wheel & Tires

Wheel rim size	14 x 5.5J (alloy)
	14 x 5.5J (steel)
Tire size & type	175/70 R14 84T & Radial, tubeless

CAPACITIES AND SPECIFICATIONS



Fluid Chart

Item	Classification	Capacity
Engine Oil	5W-30ACEA A3/B4	3.2 L
Transmission Oil	BOT (303) Mod	1.6 L
Engine Coolant	Ethylene glycol based long life coolant	7.0 L
Brake / Clutch Fluid	DOT 4	0.48 L
Power Steering Fluid	Dexron VI	1.0 L

Fuel Tank

Diesel, Nominal Capacity	40 L
--------------------------	------

Tire Pressures

TIRE AND SEATING INFORMATION			
OCCUPANTS	TOTAL 5	FRONT 2	REAR 3
			
TIRE	SIZE	COLD TIRE PRESSURE	
FRONT	175/70 R14 84T	235 kPa, 34 psi	
REAR	175/70 R14 84T	235 kPa, 34 psi	
SPARE	175/70 R14 84T	235 kPa, 34 psi	

SERVICE AND WARRANTY

Standard Limited Warranty Coverage	154
Predelivery Inspection and Vehicle Delivery	161
Owner's Statement of Acceptance	163
Chevrolet Service	165
Maintenance Record Sheet	171
Battery	173
Separate Corrosion Protection Service	174
Body Inspection Record	175
Emission Warranty	177
Annexure - I	181
Annexure - II.....	182

154 Service and Warranty

STANDARD LIMITED WARRANTY COVERAGE

1. SCOPE

General Motors India Private Limited, a private limited company incorporated under the companies Act 1956 bearing CIN U34100GJ1994PTC021818 and having its Registered office at Shreenathji Compound, Survey No. 1871, Naz Road, Village Jetalpur, Taluka Daskroi, Ahmedabad, Gujarat – 382 426 and Works at A-16, MIDC Talegaon Industrial Area (Phase-II), Near Floriculture Park, Talegaon Navlakh Umbhre Village Road, Tehsil-Maval, Pune - 410507, Maharashtra (“General Motors India”) warrants that your new Chevrolet Sail Hatchback ("vehicle") is free from defect in material or workmanship, subject to your compliance with the following terms and conditions mentioned hereunder and other vehicle maintenance norms as mentioned elsewhere in this service booklet. Only an authorized CHEVROLET retailer as mentioned in this booklet will make the necessary repairs, using new, re-conditioned or re-manufactured parts with a view to correcting any defect covered by this warranty.

2. WHAT IS COVERED

Time and distance limits for New Vehicle Warranty coverage.

Warranty Type	Warranty Limits	Other Warranties
A : General	Three (3) years or 1,00,000 kms (whichever is earlier) from the date of delivery by a CHEVROLET retailer or the date of first registration of the motor vehicle, whichever occurs first.	These parts are covered by other warranties : 1. Battery (one (1) year) (covered by the battery manufacturer**) 2. Tires (one (1) year) (covered by the tyre manufacturer**) 3. Audio/Radio/Acc. (one (1) year) (covered by the Audio/Radio/Acc. manufacturer**) See Clause 5.
B : Rust Through*	Three (3) years from the date of delivery of the motor vehicle or from the date of first registration of the motor vehicle, whichever occurs first.	The warranty covers exterior body metal except : 1. Items not covered by warranty listed in Clause 3 2. Exhaust pipe and fuel system rust

* A hole through a body panel caused by rust / corrosion from inside to outside.

** Service / warranty shall be provided by the concerned equipment manufacturer.

- The obligation under this New Vehicle Warranty is limited to the repair of the new motor vehicle at no charge by the CHEVROLET authorized retailer. For parts replaced during such repair the same warranty applies until the end of the New Vehicle Warranty period as stipulated herein. All warranty claims expire at the end of the warranty period as specified under Clause 2. The Owner is responsible for any repair or replacement which are not covered by this warranty.
- Liability of **General Motors India Pvt. Ltd.** under this New Vehicle Warranty is limited to the value of the service, repairs/ replacement of parts found to be defective within the warranty period. Beyond servicing and/or repairing defective parts in the vehicle, **General Motors India Pvt. Ltd.** does not undertake to replace the vehicle / or reimburse the purchaser by payment of any money in respect of the vehicle purchased by them.
- Under the terms of New Vehicle Warranty, installation, free service will be provided only within the municipal limits of the cities/towns where **General Motors India Pvt. Ltd.** has its service network, *as elaborated elsewhere in this Owner's Manual*. This list of authorized retailers is subject to change/modification without prior notice. Service outside the municipal limits specified above will be provided after charging the actual to and fro traveling and incidental expenses, as prevailing from time to time.
- Necessary care and caution is taken in manufacturing of the vehicle, however, **General Motors India Pvt. Ltd.** shall not be liable for any loss or damage caused to any article, property, death or disability caused to any human life arising out of fire, electric fault, short circuit, accidental handling or negligent use of the vehicle. The maximum liability in monetary terms shall be restricted to the value of the defective parts and / or value of services rendered only. Furthermore, the New Vehicle Warranty, in no case, shall extend to the payment of any monetary consideration whatsoever, of the replacement or return of the vehicle as a whole.
- The decision of **General Motors India Pvt. Ltd.** will be final and binding on all matters arising out of this New Vehicle Warranty.
- The owner should preserve the original Invoice for necessary verification and produce the same, as and when required.
- The optimum performance of the vehicle is under standard test conditions.

This New Vehicle Warranty is issued at Talegaon, District Pune, Maharashtra and competent courts shall have exclusive jurisdiction over matters by or following from time to time.

3. WARRANTY LIMITATIONS

The warranty will cease to exist in following conditions:

- a. Failure to have the required periodic inspection and required service performed as per the Periodic Maintenance Schedule.
- b. Improper or wrong maintenance and in deviation with guidelines mentioned in this service booklet.
- c. Any modification, alterations made to the vehicle such as including but not restricted to adding lights, changing engine specifications to increase horsepower, or using wide tires, and or any other modification in the vehicle that may likely to have an effect on the performance of the vehicle. (e.g. Defects caused by the installation of non homologated wheels and tires are not covered by the warranty.)
- d. Failure to use genuine parts / fluids (oil, coolant, brake / clutch fluid) and/or other accessories / consumables recommended or approved by General Motors India Pvt. Ltd.
- e. Use of the vehicle for purposes or in a manner other than the one mentioned in the Owner's Manual. Exceeding specified capacities such as loading weight, passenger, speed, use as a commercial vehicle and rpm limitations.
- f. Damage caused by driving the vehicle under severe conditions such as un-pliable or water-logged roads, in races or rallies.
- g. Damage caused by natural disasters including but not restricted to earthquakes, storms, floods, fire and accidents. The owners are recommended to keep their vehicle insurance valid at all times.
- h. Damage caused by smoke, chemicals, bird-droppings, salt, stone chipping, scratches, iron dust or any other extraneous circumstances like external mechanical or chemical influences (regarding paint or body damage, specially stone throw, air-borne rust, industrial fall out), damage to catalytic converter due to use of wrong/bad quality fuel acting on the vehicle.
- i. Damage caused by normal wear (for instance brake-pad, etc.) or exposure to the elements such as discoloring or deformation of any interior, plastic, chrome or painted part or surface.
- j. Sensory complaint by the owner against symptoms such as noise, vibration or oil stains which do not effect performance.

- k. Damage which should have been detected during normal usage but became serious when left unattended to and/or the owner of the vehicle having failed to claim and having rectified a defect which was already apparent during vehicle delivery, immediately after delivery or a defect which becomes apparent at a later date immediately after it became apparent.
- l. Failure of the owner to adhere to the requirements outlined in Clause 4.
- m. Fuel system damage caused by water or other foreign matter in the fuel system.
- n. Damage caused by the installation of non genuine accessories or equipment after the vehicle has been purchased from the CHEVROLET retailer such as radio, car telephone, CD radio set, or cargo carrier and / or other activities of a similar nature.
- o. Damage caused by running vehicle on adulterated fuel/lubricants or fuel/lubricants other than those specified by General Motors India Pvt. Ltd.
- p. Repair of the vehicle by an unauthorized service center during warranty period.

WHAT IS NOT COVERED

- Adjustments, cleaning, inspection, or required periodic maintenance.
- Parts designated as requiring periodic replacement.
- Warranty repair not performed by a CHEVROLET retailer.
- Charges or fees for telephone, tow, transportation charges of the vehicle to the nearest CHEVROLET retailer, rental car, and so forth; compensation for inconvenience or commercial losses; all other consequential costs relating to the owner being unable to use the vehicle.
- Any accident, damage, loss or destruction due to negligent, careless use of vehicle.
- Damage to the engine while driving in water logged conditions or entry of water in to the engine.
- Consumptive parts and oil/grease and other fluids. (See the following tables of consumptive parts and oil/grease and other fluids.)
- External damage / Underbody hit by negligent or careless driving.

Consumptive Parts	Oil/Grease and other fluids
Drive belts	Engine oil
Air cleaner element	Transmission oil
Fuel filter	Power steering fluid
Oil filter	Brake / Clutch fluid
Clutch disc, clutch parts	Coolant
Brush holders	Grease
Brake shoe and pads	Washer fluid
Brake discs	Battery fluid
Brake drums	Gasoline
Wiper blades	Diesel
Light bulbs	Air conditioner refrigerant
Motor brushes	Other lubricants, etc.
Hoses	
Fuses, etc.	

No warranty repair shall be made if it is found that the vehicle identification number like chassis / engine number, odometer or the warranty & service booklet, have been tampered with. This list is neither exclusive nor exhaustive and the decision of General Motors India Pvt. Ltd. shall be final and binding.

4. WHAT THE OWNER MUST DO

In order to keep this warranty valid you must:

- a. Use your vehicle as instructed in the Owner's Manual.
- b. Have your vehicle inspected according to this schedule.

The cost of the service is borne by the owner. If the services are not performed within the specified time limits, the general and the rust through warranty as referred to under Clause 2 above, shall be rendered null and void and shall not be reinstated by a subsequent service.

- c. Keep the warranty & service booklet (Owner's Manual) and all receipts in a safe place to present to the CHEVROLET retailer at regular maintenance visits and when repair work is required.

5. PARTS COVERED BY OTHER WARRANTY CONDITION

- a. Battery : The coverage period is 1 year from the date of new vehicle registration regardless of the distance traveled.
- b. Tires : This warranty is covered by the tire manufacturer. The coverage period is one year. Please check with your CHEVROLET retailer for details.
- c. Audio/Radio/Acc. : This warranty is covered by the audio/radio/Acc. manufacturer. The coverage period is one year. Please check with your CHEVROLET retailer for details.

6. MAKING THE WARRANTY EFFECTIVE

The warranty goes into effect after CHEVROLET authorized retailer fills in the appropriate information about your vehicle and places the retailer's official seal and signature in the warranty & service booklet (Owner's Manual).

7. REQUIREMENTS FOR WARRANTY WORK

To have warranty work carried out, present the warranty & service booklet (Owner's Manual) to the authorized CHEVROLET retailer as mentioned in this booklet. If the warranty & service booklet is lost or incomplete, work to be carried out with respect to the standard warranty shall be refused.

8. CHANGE OF OWNERSHIP

If the vehicle is sold during the warranty period, please deliver the warranty & service booklet (Owner's Manual) to the new owner.

The new owner will need to complete the change of address or subsequent ownership notification card located elsewhere in this booklet in order for the coverage to be transferred.

9. EXPENSES ASSOCIATED WITH WARRANTY WORK

The expenses of repair work and parts of your CHEVROLET vehicle will be covered by CHEVROLET standard limited warranty in accordance with the WARRANTY & SERVICE BOOKLET (OWNER'S MANUAL). Other expenses that are not covered by the CHEVROLET Standard Limited Warranty must be covered by the owner.

10. General Motors India Private Limited is launching the Chevrolet Sail Hatchback in different cities in a phased manner. The CHEVROLET retailer responsible for delivering your Sail Hatchback is qualified to provide all Sail Hatchback related services within the city where he is located. As other CHEVROLET retailers become operational to handle the Sail Hatchback, they will also be able to provide similar Sail Hatchback related services. **IN ORDER FOR THE WARRANTY ON YOUR VEHICLE TO APPLY, IT IS IMPERATIVE THAT YOUR SAIL HATCHBACK BE SERVICED, HANDLED AND ATTENDED TO ONLY BY CHEVROLET RETAILER AS SET FORTH IN THIS BOOKLET.**

11. The following requisite document should be presented to the CHEVROLET retailer at the time of making a claim under New Vehicle Warranty:

- Original invoice issued by CHEVROLET retailer.
- Warranty and service booklet / maintenance record.
- Any other document deemed to be necessary by CHEVROLET retailer and/or General Motors India Pvt. Ltd.

PREDELIVERY INSPECTION AND VEHICLE DELIVERY

Before delivering the vehicle we carried out a thorough predelivery inspection in order to ensure that your Chevrolet vehicle is in a fault-free condition. Accompanying this appropriately filled out service booklet (Owner's Manual) are the tool kit and your vehicle documents.

You have been informed of the service intervals and necessary service checks, including under extreme operating conditions and in particular with regard to oil changing of diesel engines.

City, date :

CHEVROLET Retailer's / ASO's Stamp and Signature

**OWNER'S
STATEMENT OF ACCEPTANCE**

I hereby certify that the vehicle has been delivered in an orderly and proper operating condition, including **Keys, Service Booklet (Owner's Manual) and Tool Kit. I have read and understood the terms and conditions pertaining to the New Vehicle Warranty and agree to abide by the same.**

I have been informed of the service intervals and necessary service checks, including under extreme operating conditions.

Date of delivery :

City, date :

Name and signature of customer :

This sheet must be detached prior to vehicle delivery and placed with the vehicle file **after it has been signed** by the customer.



Dear Customer,

We are confident that you and your family would be enjoying the safe and comfortable drive of the Chevrolet Sail Hatchback.

We would like to undertake a thorough check-up of the vehicle at 1000 kms or 30 days, whichever occurs earlier. This will also allow us to re-emphasize the salient features of the Sail Hatchback to you.

In the unlikely event of an emergency assistance, please call your nearest CHEVROLET retailer as mentioned in this booklet or please feel free to call our 24 hr. helpline at 1800 3000 8080.

**1st Free Inspection - 1 Month / 1000 km
(whichever occurs earlier)**

VIN no. _____

PDI no. _____

Date of service _____

Date of delivery _____

Retailer code _____

Customer's name _____

Customer's tel. no. _____

I confirm that the vehicle has been inspected and delivered to my satisfaction.

Retailer's Signature

Customer's Signature

1st Free Inspection - 1 Month / 1000 km (whichever occurs earlier)

GENERAL STATUS REVIEW

Check closing efforts of doors Keyless entry system

Other functions

Under hood

Check fluid levels Engine oil level

Brake / Clutch oil level Coolant level

M/T oil Windshield washer level & add washer fluid

UNDERBODY, WHEELS

Visually check routing, leaks & damage Check tire pressure

ELECTRICAL CHECKS

Malfunction indicator lamp Charging lamp

Oil pressure lamp Glow plug lamp

Parking brake lamp/indicator High beam/Turn signal Hazard indicator

All other telltale lamp Rear defogger

Check lighting system Horn/Radio/Outside Mirrors

High/Low beam/Hazard signal Turn signal/Flash to pass signal

Front/Rear fog lamps/Tail lamps Stop lamp/Reversing lamp/Trunk lamp

DYNAMIC EVALUATION

Steering function/noise/abnormal drag Clutch & gear shifting function/ noise

Accelerating & braking function/ noise Check tires

Any other abnormal noise

Note - Cost of materials and consumables to be borne by customer.

For detailed information refer section 'Service and Maintenance'.

2nd Free Inspection - 6 Months / 5000 km (whichever occurs earlier)

ENGINE CONTROL SYSTEM

- | | | | |
|---|--------------------------|-------------------------------------|--------------------------|
| Drive Belt
(Alternator, Power Steering and A/C Compressor) | <input type="checkbox"/> | Engine Oil | <input type="checkbox"/> |
| Engine Oil Filter | <input type="checkbox"/> | Cooling System Hose and Connections | <input type="checkbox"/> |
| Engine Coolant | <input type="checkbox"/> | Fuel Filter | <input type="checkbox"/> |
| Fuel Line and Connections | <input type="checkbox"/> | Air Cleaner Element | <input type="checkbox"/> |
| PCV System | <input type="checkbox"/> | EPV Filter (If available) | <input type="checkbox"/> |

CHASSIS AND BODY

- | | | | |
|---|--------------------------|---|--------------------------|
| Exhaust Pipe & Mountings | <input type="checkbox"/> | Brake / Clutch Fluid | <input type="checkbox"/> |
| Front Brake Pads & Discs | <input type="checkbox"/> | Rear Brake Drum & Linings | <input type="checkbox"/> |
| Parking Brake | <input type="checkbox"/> | Brake Line & Connections (Including Booster) | <input type="checkbox"/> |
| Manual Transaxle Fluid : Leak Check | <input type="checkbox"/> | Tire Condition and Inflation Pressure | <input type="checkbox"/> |
| Steering Wheel & Linkage | <input type="checkbox"/> | Power Steering Fluid & Line | <input type="checkbox"/> |
| Wheel Alignment
(As and when required or as suggested by
CHEVROLET retailer.) | <input type="checkbox"/> | Wheel Balancing
(As and when required or as suggested by
CHEVROLET retailer.) | <input type="checkbox"/> |
| Drive Shaft Boots | <input type="checkbox"/> | Safety Belts, Buckles & Anchorages | <input type="checkbox"/> |
| Lubricate Locks, Hinges & Hood Latch | <input type="checkbox"/> | A/C Mesh Filter | <input type="checkbox"/> |
| Chassis and Underbody Bolts and
Nuts Tight / Secure | <input type="checkbox"/> | | |

Note - Cost of materials and consumables to be borne by customer.
For detailed information refer section 'Service and Maintenance'.

CHEVROLET Inspection

2nd Free Inspection - 6 Months / 5000 km (whichever occurs earlier)

VIN _____

Regn. No. _____

Delivery date _____

Date of service _____

Kms _____

I confirm that the job has been attended to my satisfaction.

Customer's Signature

Labour free & Parts are chargeable
(Retain with job card)

168 Service and Warranty

Delivering Retailer's stamp & date

I hereby certify that the work has been carried out as per the schedule.

Servicing Retailer's / ASO stamp & date

3rd Free Inspection - 1 Year / 10000 km (whichever occurs earlier)

ENGINE CONTROL SYSTEM

- | | | | |
|---|--------------------------|-------------------------------------|--------------------------|
| Drive Belt
(Alternator, Power Steering and A/C Compressor) | <input type="checkbox"/> | Engine Oil (Replace) | <input type="checkbox"/> |
| Engine Oil Filter (Replace) | <input type="checkbox"/> | Cooling System Hose and Connections | <input type="checkbox"/> |
| Engine Coolant | <input type="checkbox"/> | Fuel Filter | <input type="checkbox"/> |
| Fuel Line and Connections | <input type="checkbox"/> | Air Cleaner Element (Replace) | <input type="checkbox"/> |
| PCV System | <input type="checkbox"/> | EPV Filter (If available) | <input type="checkbox"/> |

CHASSIS AND BODY

- | | | | |
|---|--------------------------|---|--------------------------|
| Exhaust Pipe & Mountings | <input type="checkbox"/> | Brake / Clutch Fluid | <input type="checkbox"/> |
| Front Brake Pads & Discs | <input type="checkbox"/> | Rear Brake Drum & Linings | <input type="checkbox"/> |
| Parking Brake | <input type="checkbox"/> | Brake Line & Connections (Including Booster) | <input type="checkbox"/> |
| Manual Transaxle Fluid : Leak Check | <input type="checkbox"/> | Tire Condition and Inflation Pressure | <input type="checkbox"/> |
| Steering Wheel & Linkage | <input type="checkbox"/> | Power Steering Fluid & Line | <input type="checkbox"/> |
| Wheel Alignment
(As and when required or as suggested by
CHEVROLET retailer.) | <input type="checkbox"/> | Wheel Balancing
(As and when required or as suggested by
CHEVROLET retailer.) | <input type="checkbox"/> |
| Drive Shaft Boots | <input type="checkbox"/> | Safety Belts, Buckles & Anchorages | <input type="checkbox"/> |
| Lubricate Locks, Hinges & Hood Latch | <input type="checkbox"/> | A/C Mesh Filter | <input type="checkbox"/> |
| Chassis and Underbody Bolts and
Nuts Tight / Secure | <input type="checkbox"/> | | |

Note - Cost of materials and consumables to be borne by customer.
For detailed information refer section 'Service and Maintenance'.

CHEVROLET Inspection

3rd Free Inspection - 1 Year / 10000 km (whichever occurs earlier)

VIN _____

Regn. No. _____

Delivery date _____

Date of service _____

Kms _____

I confirm that the job has been attended to my satisfaction.

Customer's Signature

Labour free & Parts are chargeable
(Retain with job card)

170 Service and Warranty

Delivering Retailer's stamp & date

I hereby certify that the work has been carried out as per the schedule.

Servicing Retailer's / ASO stamp & date

BATTERY

Battery type : _____

Battery make : _____

Battery batch code/ Sl. No. : _____

Important Instructions

- The battery must be fitted firmly in the cradle.
- Connecting cables and connectors must be fastened securely on to the battery.
- Connections must be made in the right polarity.
- Terminals must be kept coated with petroleum jelly/vaseline. DO NOT USE GREASE.
- Battery top & vent plugs must always be kept clean & dry .
- Electrolyte level must always be maintained in line with the bottom of the vent hole. In case of any drop in electrolyte level, add pure distilled water. NEVER ADD ACID.
- Battery is warranted for a period of one year only.
- Liability under this warranty is limited to defects arising out of faulty material or workmanship developing under proper use and NOT when the battery is merely discharged.

- Defects arising out of faulty vehicle electrical systems, negligent maintenance, incorrect charging or improper filling of the battery by unauthorized dealers/auto electricians are not covered by warranty.
- Consequent liabilities are not covered by this warranty policy.
- Get battery checked every 3 months.

CHEVROLET retailer's
Stamp

**SEPARATE
CORROSION PROTECTION
SERVICE**

Body/ Underbody Corrosion Protection Service

General Motors India Pvt. Ltd. provides a three (3) years or 1,00,000 kms (whichever is earlier) warranty vehicle that no rust-through of the body/underbody will occur, provided that the directives from General Motors India Pvt. Ltd. concerning the treatment, maintenance, and care of the vehicle (Owner's Manual) and especially the inspection and checks prescribed in the service booklet have been carried out.

Furthermore, the body paintwork and the corrosion protection must be visually inspected for damage as part of the regular annual inspection or 10,000 kms service. The customer is informed of any damage detected and measures to rectify this damage. Any damage discovered is also indicated in the following corrosion protection diagram.

Confirmation of the inspection is indicated by a stamp and dated signature, accompanied by indication of the vehicle mileage on the following verification documents.

Make use of this possibility in order to avoid problems during warranty claims regarding rust- through of the body / underbody.

The rust through warranty is not applicable if areas damaged by any reason remain unattended and become the cause of corrosion.

All repairs when required should be carried out promptly and by the CHEVROLET retailer.

BODY INSPECTION RECORD

Vehicle identification number _____

Registration number _____

Name / address of owner _____

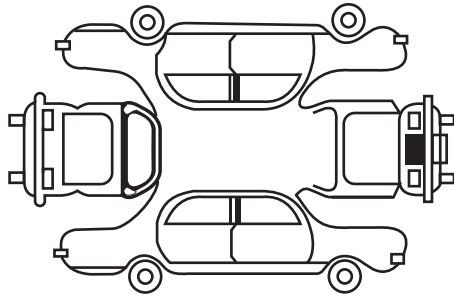

Use the following symbols to indicate damage.

- Chipping × Dent / Bumpy
- ▲ Scratch ■ Other damage
- ↑ Antirust re-treatment necessary

In order to maintain the General Motors India Pvt. Ltd. rust-through warranty, the vehicle must be subjected to an inspection by CHEVROLET retailer once a year. Any resulting work is subject to a charge.

Check-up 1st year after initial registration.

Check-up date _____

Odometer reading _____

- Damage found
- | | | | | |
|-----------------------|-----|--------------------------|----|--------------------------|
| 1. Outer body | Yes | <input type="checkbox"/> | No | <input type="checkbox"/> |
| 2. Under body | Yes | <input type="checkbox"/> | No | <input type="checkbox"/> |
| 3. Engine compartment | Yes | <input type="checkbox"/> | No | <input type="checkbox"/> |

Retailer stamp / signature _____

Damage repaired Yes No

Remarks : _____

BODY INSPECTION RECORD

Vehicle identification number _____

Registration number _____

Name / address of owner _____

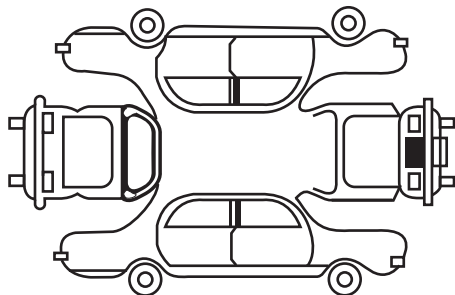

Use the following symbols to indicate damage.

- Chipping × Dent / Bumpy
- ▲ Scratch ■ Other damage
- ↑ Antirust re-treatment necessary

In order to maintain the General Motors India Pvt. Ltd. rust-through warranty, the vehicle must be subjected to an inspection by CHEVROLET retailer once a year. Any resulting work is subject to a charge.

Check-up 2nd year after initial registration.

Check-up date _____

Odometer reading _____

- Damage found
- | | | |
|-----------------------|------------------------------|-----------------------------|
| 1. Outer body | Yes <input type="checkbox"/> | No <input type="checkbox"/> |
| 2. Under body | Yes <input type="checkbox"/> | No <input type="checkbox"/> |
| 3. Engine compartment | Yes <input type="checkbox"/> | No <input type="checkbox"/> |

Retailer stamp / signature _____

Damage repaired Yes No

Remarks : _____

EMISSION WARRANTY

(Applicable in NCR Delhi, Chennai, Kolkata and Mumbai)

Subject to other terms of the warranty policy and the conditions and obligations laid down hereunder, General Motors India Pvt. Ltd., certifies that the components liable to affect the emission of the gaseous pollutants in the vehicle in the normal use despite the use to which it may be subjected, comply with the provisions of Rule 115 (2) of the Central Motor Vehicle Rules, 1989, and further warrants that if on examination by a service center duly authorized by the General Motors India Pvt. Ltd., the vehicle is discovered to be failing to meet the emission standard as specified in the said rule, our authorized service center shall take such corrective measures as may be necessary and shall at its sole discretion either repair or replace free of charge such components of emission control system as are specified in Annexure II hereof.

The definitions of various terms used in Emission warranty proposal are given in Annexure –I. These definitions shall

be in line with the definition of the existing product Warranty definition.

Conditions :

1. This warranty will be in addition to and will run concurrently and parallel to the product warranty and will apply only in respect to components as mentioned in Annexure-II.
2. The period of the vehicle's warranty shall commence from the date of the vehicle sale.
 - 2.1 Warranty period - **1,00,000 kms or 3 years** whichever occurs earlier, from date of the vehicle sale.
3. The warranty claim will be accepted only after examination carried out by CHEVROLET retailers leading to a firm conclusion that none of the original settings/specifications have been tampered with and that the components (s) as mentioned in Annexure –II has/have a manufacturing defect, and/or, that the vehicle is unable to meet the In-use emission standards.
4. The methods of examination to determine the warrantable condition of the components will be at sole discretion of General Motors India Pvt. Ltd. and or its retailers and results of such examination will be final and binding. If, on examination, the warrantable condition is not established, General Motors India Pvt. Ltd. will have the right to charge full, or part, of the cost of such examination and resulting repairs/rectification
5. In case of acceptance of the warranty under Emission Warranty, General Motors India Pvt. Ltd. will replace, at retailers, free of charge, the components which are covered as mentioned in Annexure-II, but the consumables as mentioned in OM shall be charged as per actual applicable rates.
6. In case of a vehicle in which the components covered under Emission Warranty or the associated parts, are not independently

replaceable, on account of their being integral parts of a complete assembly, will have the sole discretion to replace either the entire assembly or by using some of the parts of the system through suitable repairs or modifications.

7. Any consequential repairs or replacement of parts which may be found necessary to establish compliance to In-use emission standards, in addition to the replacement of the components covered under Emission Warranty, will not be made free of cost unless such parts are also found to be in a warrantable condition within the scope and limit of the product Warranty (Chevrolet Sail Hatchback -3 years/1,00,000 kms, whichever is earlier). The consumables and labour shall be charged per actual during such repairs or replacement of parts.
8. All the parts removed for replacement under warranty will be the

property of General Motors India Pvt. Ltd.

9. General Motors India Pvt. Ltd. will not be responsible for the cost of transportation of the vehicle to the nearest retailer or any loss due to non-availability of the vehicle during the period of a warranty claim and examination by CHEVROLET retailers.
10. General Motors India Pvt. Ltd. will not be responsible for any fines, penalties that may be charged by Statutory or Regulatory authorities on account of failure of the vehicle to comply with the in-use emission standards on the vehicle not meeting any such given legal/regulatory requirement, during inspection by such authorities.
11. Emission Warranty will be applicable irrespective of the change of ownership of the vehicle provided all the conditions as laid down in this document are met from the date of original sale of the vehicle.

This Emission Warranty will be applicable only if the customer :

- (I) Observes all the important instructions and any other precautions listed in the OM for use of the vehicle.
- (ii) Under all circumstances uses lubricants and fuel as recommended by General Motors India Pvt. Ltd.
- (iii) Regularly obtains and carries out maintenance at CHEVROLET retailers as per the list in this booklet only, in accordance with General Motors India Pvt. Ltd. guidelines and enters the details in the Service Booklet.
- (iv) Immediately approaches the nearest Authorized Service Center as per the list in this booklet upon discovery of failure to comply with the In-use emission standard inspite of having maintained and used the vehicle in accordance with the instructions in the OM and having

carried out such repairs and adjustments as may be required with a view to establish such compliance.

- (v) Produces the 'Pollution Under Control (PUC)' certificate valid for the period immediately preceding the test during which the failure is discovered, the test having been carried out either for obtaining a new certificate, or pursuant upon being directed by an officer as referred to in sub – rule (2) of Rule 116 of the Central Motor Vehicles Rules.
- (vi) Produces the service booklet (Owner's Manual) and all relevant bills for verification of details.
- (vii) Produces receipts covering maintenance of the vehicle as specified in the OM from the date of original purchase of the vehicle.
- (viii) Produces valid certificate of insurance & RTO registration.

Conditions under which warranty is NOT applicable:

- 1. Non production/availability of a valid 'Pollution under Control' certificates as described in customer obligation (V).
- 2. In case the vehicle is not serviced by CHEVROLET retailers as per the list in this booklet as per the service schedule described in the maintenance chart given in the Owner's Manual.
- 3. A vehicle, which has been subjected to abnormal use, abuses, neglect and improper maintenance or has met with an accident.
- 4. Use of such replacement parts, which are not specified and approved by General Motors India Pvt. Ltd.
- 5. If the vehicle or parts thereof, have been altered, tampered with or modified or replaced in an unauthorized manner.

- 6. A vehicle on which the odometer is not functioning or the odometer has been changed or the reading of which has been changed / tampered with so that the actual mileage cannot be readily determined.
- 7. A vehicle, which has been used, for competitions, races, rallies or for the purpose of establishing records.
- 8. Examination by CHEVROLET retailers as per the list in this booklet of the vehicle shows that any of the conditions stipulated in the OM with regard to use and maintenance have been violated.
- 9. A vehicle, which has been run on adulterated fuel or lubricant or fuels lubricants other than those, specified by General Motors India Pvt. Ltd.

Scope and Limits:

- 1. This emission warranty is in addition to the product warranty for the vehicle as per the scope and

limit described in the OM and all conditions described therein will apply, in addition to those exclusively stipulated in this warranty.

2. The emission warranty covers only compliance with the emission standard as specified in sub rule (2) of Rule 115 of CMVR. It does not cover any other performance of these parts or routine test and consequent maintenance or adjustments to establish compliance to the in-use emission standard as applicable to the state, in which the vehicle is registered and is in use.

ANNEXURE-I

Definitions:

1. **Vehicle** : The Motor Vehicle approved for sale within India under the provisions of Central Motor Vehicle Rules, 1989 or any subsequent amendment or substitution thereof.
2. **Owner's Manual (OM)** : A document given to the customer at the time of sale of the vehicle giving guidelines on use and maintenance of the vehicle including the terms and conditions of Warranty.
3. **Maintenance** : Maintenance as per the schedule provided in the Owner's Manual by General Motors India Pvt. Ltd. including inspection, verification check, adjustment and replacement, if necessary.
4. **Service Booklet** : The scheduled service record book in Owner's Manual, which is required to be filled by CHEVROLET retailer at the time of service.
5. **Abnormal Use** : The situations when the vehicle is put to use other than that intended by General Motors India Pvt. Ltd. such as racing, overloading or use of adulterated fuel or fuel not recommended by General Motors India Pvt. Ltd.
6. **Manufacturing Defect** : Means deficiency or deviation from normal production tolerance in design, material, or workmanship in a device or system which affects any parameter, performance, or component belonging to emission control system.
7. **Product Warranty** : The manufacturer warranty as provided by General Motors India Pvt. Ltd., which covers failure of various parts and systems as per the Owner's Manual 3 years/1,00,000 kms, whichever is earlier.
8. **Emission Warranty** : Warranty for emission performance of the vehicle as determined by sub-rule (2) of rule no 115 of the Central Motor Vehicles Rules, 1989.
9. **Authorized Service Centers** : Any service facilities authorized by General Motors India Pvt. Ltd. to perform warranty repairs. This shall include all of CHEVROLET retailers that are recognised for service of subject vehicles or any other service center duly authorized by General Motors India Pvt. Ltd.
10. **Warrantable Condition** : Warrantable condition means any condition of a vehicle, which triggers the responsibility of General Motors India Pvt. Ltd. to take corrective action within the framework of emission Warranty. This however shall not include any statutory or regulatory fines or penalties.
11. **Warranted Parts** : Those components, listed as per Annexure-II.

ANNEXURE-II

List of Components Covered under Emission Warranty

S. No.	Part name
1	Catalytic Converter***
2	Exhaust Manifold Gasket
3	Electronic Control Module
4	Mass Air Flow Sensor
5	Accelerator Pedal Position Sensor
6	Fuel Pressure Regulator Valve
7	Air Temperature Sensor
8	Coolant Temperature Sensor
9	Injectors
10	High Pressure Pump
11	Exhaust Gas Re-circulation Valve
12	Fuel Pump

*** Catalytic Converter is covered only for emission related failures as provided under the warranty statement. Replacements if any shall not be applicable for breakage and noise problems.

Note : All the above mentioned parts are covered only if the car fails to meet the prescribed Emission norms. Any other performance problems shall be treated as not relevant to the Emission warranty.

24x7 ROADSIDE ASSISTANCE

How to Request Assistance	184
Benefits	185
Covered Area	185
Chevrolet Roadside Assistance at Home or on the Road	185
Vehicle Recovery Following Mechanical or Electrical Breakdown	185
Vehicle Recovery Following an Accident	186
Taxi Benefit	186
Urgent Message Relay	186
Locked Keys/Lost Key	186
Non Covered Events Under the Chevrolet Roadside Assistance Program	186
Special Exclusions	188
Adverse Weather	188
Force Majeure	189
External Factors	189
Right of Refusal	189
Disputes	189
Summary	189
Disclaimer	190



24x7x365 Days Access to Toll Free Number



Fuel Assistance



Taxi Assistance



Tyre Assistance

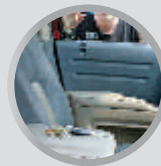

Key Lockout Services



Towing Facility

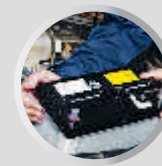

Battery Jump Start

184 24x7 Roadside Assistance

The Chevrolet Roadside Assistance Program is focused to enhance your overall Chevrolet ownership experience by providing 24x7 Roadside Assistance emergency support for a period of three years starting from the date of invoice of the Chevrolet vehicle sold from an authorized CHEVROLET retailer, in the unfortunate event of vehicle breakdown or accident of your Chevrolet vehicle. The Chevrolet Roadside Assistance Program has specially been designed to take care of your car's safety and your comfort. The Benefits and the Terms & Conditions of the Chevrolet Roadside Assistance Program are mentioned in this Owner's Manual. You are therefore, requested to read this Owner's Manual very carefully.

HOW TO REQUEST ASSISTANCE

In the event of a breakdown or accident, simply call the Chevrolet 24x7 Roadside Assistance Program on Toll Free Number* **1800 103 8090**. (*In case of difficulty in reaching this toll-free number from your phone network, please dial **0124-4388090**. Call charges apply.)

Please have the following information in hand when you call for assistance:

1. Your name and contact phone number.
2. Vehicle registration number.
3. Vehicle identification number (VIN) mentioned in the vehicle registration certificate.
4. Vehicle model.
5. Date of invoice.
6. Name of the authorized retailer from whom Chevrolet vehicle was purchased.
7. Brief description of the problem faced.
8. Specific location of the vehicle along with the nearest landmark.

The Chevrolet Roadside Assistance Program is available only if the above mentioned dial-in numbers are contacted.

REMARKS

1. Once you have called Chevrolet Roadside Assistance Program, it is advisable that you stay with your vehicle.
2. Park your vehicle on the edge of the road and put the hazard warning lights on.
3. If you are on a highway, place the warning triangle provided with the Chevrolet vehicle approximately 3 meters from the vehicle in the direction of the on-coming traffic.

BENEFITS

Chevrolet Roadside Assistance Program can be availed when your vehicle is immobilized due to:

1. Mechanical or electrical breakdown.
2. Road traffic accident where the vehicle is immobilized.
3. Human error.
4. Battery problems: Dead battery.
5. Fuel problems: Out of fuel, incorrect fuel or contaminated fuel.
6. Key problems: Locked keys, lost keys or broken vehicle keys.
7. Tyre problems: Puncture—replace with spare tyre available in the vehicle, bolts or valve related issues.

COVERED AREA

Customers are entitled to the Benefits provided under this Chevrolet Roadside Assistance Program on a PAN India level (only exception in coverage is Andaman Nicobar Islands, where this Chevrolet Roadside Assistance Program is currently not available), provided however the Chevrolet vehicle has broken down on gazette, bitumen/concrete road. Chevrolet Roadside Assistance Program will also be provided to a customer when at home, on the roadside, on the highway, in a parking lot, etc., but if you are already at an authorized CHEVROLET retailer, then you are not entitled to the Benefits under the Chevrolet Roadside Assistance Program.

CHEVROLET ROADSIDE ASSISTANCE AT HOME OR ON THE ROAD

If your Chevrolet vehicle is immobilized whether at home or on the road, Chevrolet Roadside Assistance Program personnel will attend to your Chevrolet vehicle. If the problem is something that can be resolved at the roadside, a mobile technician will be sent to mobilize your vehicle at the roadside.

VEHICLE RECOVERY FOLLOWING MECHANICAL OR ELECTRICAL BREAKDOWN

If your Chevrolet vehicle is unable to be mobilized following a mechanical or electrical breakdown, a recovery vehicle will be sent to recover your Chevrolet vehicle to the nearest authorized CHEVROLET retailer.

VEHICLE RECOVERY FOLLOWING AN ACCIDENT

If your Chevrolet vehicle is unable to be mobilized following a road traffic accident, Chevrolet Roadside Assistance Program personnel will organize to send a recovery vehicle to recover your Chevrolet vehicle to the nearest authorized CHEVROLET retailer, however all the costs towards repairs will be borne exclusively by you.

TAXI BENEFIT

If your Chevrolet vehicle is recovered to an authorized CHEVROLET retailer by Chevrolet Roadside Assistance Program personnel, the driver and passengers, if any, of the Chevrolet vehicle will be provided with one free taxi ride, up to 50 kms from the breakdown location, in order to continue your journey. The maximum number of persons that can avail this facility would, at no point of time, exceed the number of people including the driver, Chevrolet vehicle is permissible to carry under the applicable rules and regulations.

URGENT MESSAGE RELAY

You will be provided an urgent message relay service to help keep in contact with family, friends and/or work colleagues in the event of a vehicle breakdown or accident.

LOCKED KEYS/LOST KEY

Whilst we will always endeavor to provide assistance by the most efficient method, however, modern security systems sometimes make it extremely difficult for us to gain entry to your vehicle at the roadside should the spare keys not be available. If a forced emergency entry is required, you will be asked to provide the approval granting the Chevrolet Roadside Assistance Program personnel the requisite permission to gain this access and further confirm that all repair costs relating to any resulting damages to your vehicle will be your sole responsibility and borne by you or customer's car may be towed to nearest authorized CHEVROLET retailer. In the event of lost key, provision of retrieving spare key from home will be provided only, if the event has occurred in the city you are residing.

NON COVERED EVENTS UNDER THE CHEVROLET ROADSIDE ASSISTANCE PROGRAM

Chevrolet Roadside Assistance Program is designed to help in events that lead to stoppage / immobilization of your vehicle. As a result, this program will not cover any of the following events that you may encounter while driving your vehicle:

1. Faulty fuel gauge.
2. Speedometer not working.
3. Air-conditioning not working.
4. When the passenger door (s) cannot be opened and there are no passengers in the vehicle.
5. Boot cannot be opened.
6. The front and/or rear demisters are not functioning.
7. Horn is not functioning. However, if the horn is sounding continuously, the Chevrolet Roadside Assistance Services will be provided.
8. Damaged door mirrors.
9. When the rear view mirror is damaged but it does not obstruct the driver's vision.
10. Damaged or faulty fuel cap but vehicle has not run out of fuel and there is enough fuel in the tank to enable the vehicle to reach the nearest authorized CHEVROLET retailer.
11. When the sunroof cannot be opened.
12. When the sunroof cannot be closed but weather conditions are fair and the vehicle is not exposed to any security risk.
13. When the windows cannot be opened.
14. When the windows cannot be closed but weather conditions are fair and the vehicle is not exposed to any security risk.
15. Seat adjustor is faulty but the vehicle can be safely driven.
16. When the passenger seat belts are faulty but there are no passengers in the vehicle.
17. Faulty security system unless the vehicle is immobilized or unless the alarm is sounding continuously.
18. Transmission stuck in sports/winter mode.
19. When the ABS lights are illuminated.
20. Air bag warning lights are illuminated.
21. Traction control lights are illuminated.
22. Other non-safety related lights/service warnings are illuminated.
23. When your vehicle runs out of windscreen wiper fluid.
24. Front windscreen wipers faulty but weather conditions are fair.
25. Rear windscreen wiper faulty.
26. Vehicle pick-up and drop for routine maintenance is not included.

SPECIAL EXCLUSIONS

The following scenarios are special exclusions under the Chevrolet Roadside Assistance Program, and therefore neither CSIPL nor its authorized retailers will be responsible for any assistance/repair costs and are excluded from Chevrolet Roadside Assistance Program:

1. Vehicle is involved in motor racing, rallies, speed or endurance tests, practice runs or operated outside official roads.
2. Assistance is required as a result of wars, riots, uprising, mass political demonstrations, pillage, strike, use for military purposes or acts of terrorism, earthquake damage, freak weather conditions, atmospheric phenomena, nuclear transformation phenomena or radiation caused by artificial acceleration of atomic particles.
3. Breakdown is caused by deliberate damage, vandalism or participation in a criminal act or offence.
4. The immobilization is resulting from damage caused by intervention of the police or other authorities.
5. Any damage resulting from the use of the vehicle against the recommendations of the Owner's Manual.
6. Any consequential costs and/or damage to property as a result of a breakdown in or on the vehicle.
7. Any cost as a result of damage and or claim caused while the driver was operating the vehicle under the influence of alcohol, solvent abuse, drugs or other illegal substance.
8. Vehicles kept in a non-roadworthy condition or not serviced in accordance with the manufacturer's recommendations and any such other events that may be decided by CSIPL from time to time.

ADVERSE WEATHER

On occasion of adverse weather conditions such as floods, heavy rain, thunder, lightening or other external factors, which may affect our ability to provide the services effectively and it may become physically impossible to assist you until the weather improves. During such time, our main priority will be to provide the necessary assistance to you and the passengers to be taken to a place of safety. The recovery of your vehicle may not be possible until the weather condition permits.

FORCE MAJEURE

CSIPL shall not be liable for its inability to provide the services under the terms of service set out in this Owner's Manual if such inability to provide the services is caused or contributed by causes beyond CSIPL's reasonable control including but not limited to acts of god, acts of public enemy or statutory authorities or courts, terrorism, or any acts of any person engaged in subversive activity or sabotage, strikes, embargoes, public rallies and protests.

EXTERNAL FACTORS

You agree and understand that though Chevrolet Roadside Assistance Program will make every effort to reach you once you have made the call and the call is registered however, external conditions including traffic could delay such an effort.

RIGHT OF REFUSAL

Chevrolet Roadside Assistance Program shall have the right to refuse any or all benefits under the program, if it is found that the information furnished by you at the time of making the request for assistance are false.

DISPUTES

All disputes arising out of this Roadside Assistance Program shall be submitted to a sole arbitrator to be appointed by CSIPL and the place of arbitration shall be CSIPL Office at Gurgaon, Haryana. The arbitration proceedings shall be governed by the Arbitration and Conciliation Act, 1996 and shall be conducted in English. The Courts of Delhi shall have the jurisdiction.

SUMMARY

AFTER READING THIS OWNER'S MANUAL, YOU SHOULD UNDERSTAND:

1. The scope of Chevrolet Roadside Assistance Program.
2. You should at all times retain the Owner's Manual and produce whenever required.
3. This Owner's Manual must remain with the Chevrolet vehicle, if the vehicle is resold.

If you have any questions, your authorized CHEVROLET retailer / Chevrolet Roadside Assistance will be happy to assist you.

190 24x7 Roadside Assistance

DISCLAIMER

CSIPL shall be under no liability whatsoever in respect of any loss or damages arising directly or indirectly due to any delay or non-delivery of the services under the CSIPL Roadside Assistance Program. In case the vehicle cannot be mobilized on-site, Customers are advised to use the towing facility as may be arranged by CSIPL Roadside Assistance Program Vendor personnel for taking the vehicle to the nearest authorized workshop. In no condition, shall the vehicle be towed to any unauthorized workshop. Customer agrees, that it shall be a condition precedent that the Customers remove their personal belongings like laptops, wallets, mobile phone and other such valuable items before allowing the Roadside Assistance Vendor personnel to tow the vehicle and also take an inventory list of other belongings inside the vehicle including, the current physical conditions of the vehicle like dents, scratches, tools and spare tyre and to verify the list before taking possession of the vehicle from the authorized workshop. CSIPL at its discretion may refuse to render these services to any such Customers who in the reasonable discretion of CSIPL is misrepresenting the facts, in relation to the vehicle or any other details sought by the Roadside Assistance call center or the personnel and/or in the event of unruly, rude, use of abusive and foul languages, physical abuse and such other similar behavior to the Roadside Assistance Vendor's personnel by the Customer or the occupant of the vehicle. CSIPL reserves the right to change or modify any of the services and the charges thereto that are rendered in this Roadside Assistance Program without any notice.

FIND **NEW** ROADS



24x7 **ROADSIDE
ASSISTANCE**



1800-103-8090
(Toll Free No.)
0124-4388090

SERVICE NETWORK

CHEVROLET SALES INDIA SALES AND SERVICE NETWORK

North Zone	192
West Zone	197
South Zone	202
East Zone	207
International	210

- ★ Indicates Retailer (Sales and Service)
- Indicates Chevrolet Authorized Service Center
Authorized Service Center (ASC) are authorized to carry out Periodic Maintenance (Free/Paid, Minor Running Repair) Only.

The list of authorized Retailers / ASC are mentioned herein as of May, 2015. For any change in authorized Retailers /ASC, please visit www.chevrolet.co.in.

NORTH ZONE

STATE - DELHI

- * **Ganganagar Automobiles Pvt. Ltd.**
(Aarav Chevrolet)
Showroom :
11 - A, Shivaji Marg, Moti Nagar,
Opp. L & T Building, New Delhi - 110 015
Tel. : 011 - 41238888

- Workshop:**
56, Rama Road, Opposite Radha Palace Banquet Hall,
New Delhi - 110 015
Tel. : 011 - 49258888, 8826292810, 8826292815

- * **Arya Automobiles**
Showroom :
Plot No. 193, Metro Pillar No. 543,
Main Rohtak Road, Mundka, New Delhi - 110 041
Tel. : 011 - 8743030301 / 302
Fax : 011 - 28342887

- Workshop :**
KH-82/21/2 & 22/2, Phirni Road, Udyog Nagar
Industrial Area, Near Mundka Metro Pillar No. 547,
New Delhi - 110 041
Tel. : 011 - 28342884

- * **Go Auto Pvt. Ltd.**
Showroom :
A 231, Okhla Industrial Area, Phase-1,
New Delhi - 110 020
Tel. : 011 - 41855500, 9015444555

- Workshop :**
B-25, Okhla Industrial Area, Phase-1,
New Delhi - 110 020
Tel. : 011 - 41955500, 9015777888

- * **Globus Motocorp Pvt. Ltd.**
Showroom :
ZB-43 & 44/487, Zulphe Bengal, Main GT Road,
Dilshad Garden, Delhi - 110095
Tel. : 011 - 43355555

- Workshop :**
B-31, Jhilmil Industrial Area, Behind Jhilmil Metro
Station, New Delhi - 110095
Tel. : 011 - 43388888

- * **Metro Motors Pvt. Ltd.**
Showroom & Workshop :
Bawa Potteries Industrial Complex,
Aruna Asaf Ali Marg, Vasant Kunj - 110 070
Tel. : 011 - 41761717, 46156666

Showroom 2 :
A-2/6, Safdarganj Enclave,
Africa Avenue, New Delhi - 110 029
Tel. : 011 - 46146666 / 75

- * **Sparsh Autotech Pvt. Ltd.**
Showroom :
D-12 & 13, Rajapuri, Madhuvihar, Opp. Sector-5,
Dwarka, New Delhi - 110075
Tel. : 011 - 49115911

Workshop :
32/8, Shanti Garden, Matiala Industrial Area,
Near DPS School, Dwarka, New Delhi - 110059
Tel. : 011 - 49116911

- * **Triumph Motors**
Showroom :
A-9/3 Wazirpur Industrial Area, Near Richi Rich,
New Delhi - 110 052
Tel. : 011 - 47444666
Fax : 011 - 42475584

- Workshop 1 :**
C-13, Plot No. 65, SMA Industrial Area, GTK Road,
Opp. Jahangir Puri, Azadpur, New Delhi - 110 033
Tel. : 011 - 47444777

Workshop 2 :
G-14, Udyog Nagar, Rohtak Road, Peeragarhi,
Delhi - 110 041
Tel. : 011 - 42010101
Fax : 011 - 42010132

STATE - HARYANA

- * **AMBALA**
Ambala Automobiles India Ltd.
Showroom :
Ramgarh, Near Central Jail Bridge, Chandigarh Road,
Baldev Nagar, Ambala City - 134 003
Tel. : 0171 - 2543010
Fax : 0171 - 2543510

Workshop :
Barwala, Naraingarh Road, Ambala City - 134 003
Tel. : 0171 - 2678013

- * **BHIWANI**
Shailesh Automobiles
Showroom & Workshop :
Rohtak Road, Bhiwani - 127021
Tel. : 01664 - 204006/008

- * **DADRI**
Shailesh Automobiles
Showroom & Workshop :
Near Loharu Chowk, Bhiwani Road, Dadri - 127 306
Tel. : 9253660069/70

- * **FARIDABAD**
Regent Automobiles Ltd.
Showroom :
14/3, Mathura Road, Faridabad - 121 003, Haryana
Tel. : 0129 - 4088530 / 31
Fax : 0129 - 2252304

Workshop :
Plot No. 57, Sector-27C, Opp. Crown Interiorz Mall,
13/1, Mathura Road, Faridabad - 121 003
Tel. : 0129 - 2577777

- * **GURGAON**
Bhanu Motors Pvt. Ltd.
Showroom :
Shop No. 4, Omaxe Wedding Mall, Main Sohna Road,
Near Subhash Chowk, Gurgaon - 122001
Tel. : 0124 - 4757777

Workshop :
Plot No. 541, Sector-37, Part-II, Gurgaon - 122001
Tel. : 0124 - 4598888

- * **Gentech Toolings Pvt. Ltd.**
Showroom & Workshop 1 :
Plot No. 66, IDC, Opp. Sector - 14
Mehrauli - Gurgaon Road, Gurgaon - 122 001
Tel. : 0124 - 4638751 - 54, 4368787
Fax : 0124 - 4638700

Showroom 2 :
DLF City Court, Sikanderpur, Gurgaon - 122001
Tel. : 9582216504, 9582216510

○ **Orix Auto Infrastructure Services Ltd.**

Workshop :

7B, Sector - 18, Maruti Industrial Area,
Gurgaon - 122 015
Tel. : 0124 - 3014700 / 701 / 719
Fax : 0124 - 3014702

★ **YAMUNA NAGAR**

Oberoi Automobiles

Showroom & Workshop :

Aggarsain Chowk, Near Gupta Palace,
Jagadhri - 135 003
Tel. : 01732 - 212030, 212010

★ **KURUKSHETRA**

VPS Speciality Papers

Showroom & Workshop :

Plot No.145 &146, Industrial Area, Sector 2,
Kurukshetra - 136 118
Telefax : 01744 - 231050

★ **HISSAR**

Ashwani Automotors

Showroom & Workshop :

9 km Stone, OP Jindal Marg, Hissar - 125 044
Tel. : 01662 - 220710 / 11 / 12

★ **JHAJJAR**

Shailesh Automobiles

Showroom & Workshop :

Tehsil Road Jhajjar, Haryana - 124 001
Tel. : 9253660066 / 9254171300

★ **JIND**

Lekh Raj Motors Pvt. Ltd.

Showroom & Workshop :

Safidon Road, opp. Brahmin Dharamsala, Jind.
Tel. : 9992900082

★ **KAITHAL**

Lekh Raj Motors Pvt. Ltd.

Showroom & Workshop :

Ambala Road, Kaithal, Haryana - 136 027
Tel. : 0174 - 6226827

★ **KARNAL**

Aryaman Automobiles

Showroom & Workshop :

117/6, K.M. Milestone, Near Hotel New
World, G. T. Road, Karnal - 132 001
Tel. : 0184 - 2220011, 2220325
TeleFax : 0184 - 2220025

★ **PANIPAT**

Aryaman Motors

Showroom & Workshop :

Plot No 64, Sector -25, Huda Industrial Area Phase 1,
Panipat - 132 103
Tel. : 0180 - 2666222 / 2666800

★ **ROHTAK**

Badhwar Automobiles Pvt. Ltd.

Showroom & Workshop :

Sonepat Road, Rohtak - 124 001
Telefax : 01262 - 256666

★ **REWARI**

Vardhman Automobiles Pvt. Ltd.

Showroom & Workshop :

Opp. Gurudwara, Jhajhar Road, Rewari - 123 401
Tel. : 01274 - 250440 / 251188
Fax : 01274 - 255966

★ **SONIPAT**

Malwa Motors Sales Pvt. Ltd.

Showroom & Workshop :

NH-1, 31 Km Stone, G.T. Road, Kundli,
Sonipat - 131 001, Haryana
Tel. : 0130 - 2219384 - 85, 2370386, 2371386
Fax : 0130 - 2219384

★ **SIRSA**

Padam Motors Pvt. Ltd.

Showroom & Workshop :

Hisar Road, Opp Traffic Police Post, Sirsa - 125 055
Tel. : 01666 - 244445
Fax : 01666 - 244442

STATE - HIMACHAL PRADESH

★ **KANGRA**

Himachal Autowheels Pvt. Ltd.

(Platinum Chevrolet)

Showroom & Workshop :

N.H 20 Kachhiary, Kangra - 176 001
Tel. : 01892 - 260600/260601

★ **MANDI**

Ram Hari Motors Pvt. Ltd.

Showroom & Workshop :

Rani Ki Bain, Gutkar, Mandi - 175 021
Tel. : 01905 - 225692
Fax : 01905 - 221691

★ **SOLAN**

Rajvir Motors

Workshop :

Kalka Shimla Road, Near Mehta Market,
Kumarhatti, Solan, Himachal Pradesh - 173 229
Telefax : 01792 - 266338

★ **UNA**

Bhagat Ram Motorways Pvt. Ltd.

Showroom & Workshop :

Una Nangal Road, Rakkar Colony, Una - 174 303
Tel. : 01975 - 238799
Fax : 01975 - 238699

STATE - PUNJAB

★ **AMRITSAR**

S V Motors

Showroom :

Near Amritsar Gate, GT Road, Amritsar - 143 001
Tel. : 0183 - 2700102
Fax : 0183 - 2700101

Workshop :

Main GT Road, Opp. ITBP Office, Amritsar - 143 001
Tel. : 0183 - 2700201

★ **BATALA**

Kashmir Automobiles Pvt. Ltd. (Platinum Chevrolet)

Showroom & Workshop :

Opp. Cambridge International School, Saidmubarak,
Amritsar Road, Batala - 143 505
Tel.: 01871 - 241024

★ **BHATINDA**

Padam Cars Pvt. Ltd.

Showroom & Workshop :

Goniana Road, 8th Mile Stone, NH-10,
Bhatinda - 151 005
Tel. : 0164 - 27601111 / 9216350205
Telefax : 0164 - 2760153

194 Service Network

- ★ **CHANDIGARH**
Padam Motors Pvt. Ltd.
Showroom:
182/2, Industrial Area, Phase 1, Chandigarh - 160 002
Tel. : 0172 - 5212900
- Workshop :**
185, Industrial Area, Phase 1, Chandigarh -160 002
Tel. : 0172 - 5212999
- ★ **JALANDHAR**
Aakriti World
Showroom :
Ground Floor, Vasal Tower, Police Lines,
Opp. President Hotel, Jalandhar - 144 001
Telefax : 0181 - 5003333
- Workshop :**
1746 Ladowali Road, Near BSF Chowk,
Jalandhar - 144 001
Tel. : 0181 - 5057777
- ★ **LUDHIANA**
Padam Cars Pvt. Ltd.
Showroom & Workshop :
Khasara No. 279/3, G.T. Road,
Dhandari Kalan, Ludhiana
Tel. : 0161 - 2510014
Telefax : 0161 - 2510015
- ★ **Padam Motors Pvt. Ltd.**
Showroom & Workshop :
Near Ayalli Chowk, Ferozepur Road,
Ludhiana - 141 001
Tel. : 0163-6225755, 9780000609
- ★ **ROPAR**
Padam Cars Pvt. Ltd.
Showroom & Workshop :
Chandigarh Road, Nangal Chowk, Ropar - 140 001
Telefax : 01881 - 500099
- ★ **MOGA**
Padam Cars Pvt. Ltd.
Showroom & Workshop :
Near Majestic Resorts, Ferozepur Road,
Moga - 142 001
Tel. : 01636 - 225755

- ★ **NAWASHAHAR**
Aakriti World
Showroom & Workshop :
Chandigarh Road, Nawashahar, Punjab - 144 514
Tel. : 01823 - 285656
Telefax : 01823 - 285858

- ★ **PATIALA**
Padam Cars Pvt. Ltd.
Showroom & Workshop :
Main Patiala - Rajpura Road,
Opp. Caspa Resort, Bahadurgarh, Patiala - 147 001
Tel. : 0175 - 2663813 - 14, 9217100905 - 9
Fax : 0175 - 2663828

- ★ **PATHANKOT**
Kashmir Automobiles Pvt. Ltd.
Showroom & Workshop :
Simbel Chowk, Dalhousie Road, Pathankot - 145 001
Tel. : 0186 - 2257022 - 24

- ★ **SANGRUR**
Padam Cars Pvt. Ltd.
Showroom & Workshop :
College Road, Opp. Kamal Palace, Sangrur - 148001
Tel. : 9216350134, 9216911461

STATE - RAJASTHAN

- ★ **AJMER**
Rajdeep Autowheels (P) Ltd.
Showroom :
12-15, ASC Road, Vaishali Nagar, Ajmer - 305001
Tel. : 0145 - 2628989 / 2625116

- Workshop :**
Khasara No-319 Kankarda Bhunaboy, NH-8,
Jaipur Road, Ajmer - 305001
Tel. : 0145 - 2788192 / 93 / 2788222 / 23

- ★ **ALWAR**
Triumph Motors
Showroom & Workshop :
Old Delhi Road, Near Jhankar Hotel, Alwar - 301 001
Telefax : 0144 - 3047571 - 78

- ★ **BHILWARA**
Rajdeep Autowheels (P) Ltd.
Showroom & Workshop :
Payal Resort, Ajmer Road, Bhilwara - 311001
Tel. : 01482 - 265164

- ★ **BIKANER**
Sunehri Cars
Showroom & Workshop :
Plot No. 15, Transport Nagar,
NH-15, Ganganagar Road, Bikaner - 334 001
Tel. : 8003399060 / 66 / 69

- ★ **BANSWARA**
Atharva Motors Pvt. Ltd.
Workshop :
Janamedi, Udaipur Road, Banswara - 327 001
Tel. : 02962 - 250227

- ★ **CHITTORGARH**
Atharva Motors Pvt. Ltd.
Showroom :
Plot No. 86, Kabir Colony, Bhilwara Road,
Chittorgarh - 312001
Tel. : 01472 - 247598
Fax : 01472 - 247598

- Workshop :**
Near Saint Paul's School, Opp. Rajasthan State
Seed Corp., Nimbhera Road, Chittorgarh - 312 001
Tel. : 01472 - 240598

- ★ **CHOMU**
Triumph Motors
Showroom & Workshop :
Near Radha Soami Bagh, Jaipur Road,
Chomu - 303 702
Tel. : 0142 - 3304000

- ★ **JAIPUR**
Triumph Motors
Showroom I :
Corporate Tower, A-1, Jawahar Lal Marg,
Jaipur - 302 015
Tel. : 0141 - 4057575
Fax : 0141 - 4057500

Showroom 2 :

C7D, Sawai Jai Singh Highway,
Bani Park, Jaipur - 302 016
Tel. : 0141 - 4122222
Fax : 0141 - 4122233

Workshop 1 :

G-109A, Sitapura Industrial Area, Jaipur - 302 004
Tel. : 0141 - 5122333, 5113636, 5143737,
5122797, 5122798, 5143636, 4090409
Fax : 0141 - 5122552

Workshop 2 :

E-12B, Vishwakarma Ind. Area, Road No. 01,
Jaipur - 302 013
Tel. : 0141 - 4255555

Workshop 3 :

E1 - 2295, Ramchandrapura Industrial Area,
Sitapura Ext, Jaipur - 302 022
Tel. : 0141 - 4090409

JHUNJUNU

- * **Triumph Motors
Showroom & Workshop :**
G1-8, 9 & H1-16,17, Phase - 2, RIICO Industrial Area,
Jhunjunu - 333 001
Tel. : 01592 - 203163, 250001 - 3, 250145, 250146

JODHPUR

- * **Atharva Motors Pvt. Ltd.
Showroom :**
27/27A, Light Industrial Area,
Near Shastri Circle, ITI Road, Jodhpur - 342 003
Tel. : 0291 - 3048491

Workshop :

E-711, Mia Bsn, IInd Phase,
Behind Krishna Dharam Kanta, Jodhpur - 342 005
Tel. : 0291 - 3048217 - 22
Fax : 0291 - 3048223

KOTA

- * **Triumph Motors
Showroom & Workshop :**
E - 137C, Road No. 5,
Indraprastha Industrial Area, Kota
Tel. : 0744 - 2372333, 2372666

PALI

- * **Atharva Motors Pvt. Ltd.
Showroom & Workshop :**
Opp. Krishi Mandi, Jodhpur Road, Pali - 306 401
Tel. : 9414060104

SIKAR

- * **Triumph Motors
Showroom & Workshop :**
Near Circuit House, NH-11, Jaipur Sikar Road,
Sikar - 332 001
Tel. : 01572 - 245971

SRI GANGANAGAR

- * **Sunehri Cars
Showroom & Workshop :**
6th Km Stone, Surat Garh Road, NH-15,
Sri Ganganagar
Tel. : 8003399070 / 71

UDAIPUR

- * **Atharva Motors Pvt. Ltd.
Showroom & Workshop :**
A-83, Mewar Industrial Area, Madri, NH-8,
Ahmedabad Bye Pass, Udaipur - 313 002
Tel. : 0294 - 3002730, 3002769
Fax : 0294 - 2490108

STATE - UTTAR PRADESH

ALIGARH

- * **Jattari Automobile
Showroom & Workshop :**
300 Mtr. From, Bharat Petrol Pump,
Khair By Pass Road, Aligarh - 202001
Tel. : 8938802229, 8938802214

ALLAHABAD

- * **Eldee Motors
Showroom :**
Eldee Enclave, 2, S. P. Marg, Civil Lines,
Allahabad - 211 001
Tel. : 0532 - 2560743, 44

Workshop :

Kanodia Mill Compound 1, Luker Ganj,
Allahabad - 211 001
Tel. : 0532 - 2616368

AGRA

- * **Kalyan Auto Sales
Showroom & Workshop :**
Opp. Bhagwati Dhaba, Near New Sabji Mandi,
Sikandra, Agra - 282 007
Tel. : 0562 - 2640460 / 62 / 63
Fax : 0562 - 2640461

BAREILLY

- * **VAT Motors Pvt. Ltd.
Showroom & Workshop :**
4.5 KM, Rampur Road, CB Ganj, Bareilly - 243 001
Tel. : 0581 - 2560741
Fax : 0581 - 2560731

FAIZABAD

- * **Megha Auto (I) Pvt. Ltd.
Showroom & Workshop :**
Lucknow Bypass Road, Sahadatganj,
Faizabad - 224 001
Tel. : 09839099210

GORAKHPUR

- * **United Motors
Showroom :**
Kasia By-pass Road, Near Dr. Riyaz Ortho Hospital,
Mohaddipur, Gorakhpur - 273 001
Tel.: 0551 - 2201667
Fax.: 0551 - 2338299

Workshop :

Saryu Nahar Colony, Singharia,
Gorakhpur - Deoria Road, Gorakhpur - 273 008
Tel.: 0551 - 2270231

GHAZIABAD

- * **Shiva Motors
Showroom & Workshop :**
28/3/5, Site - IV, Industrial Area, Sahibabad,
Ghaziabad
Tel.: 0120 - 3008600 / 605 / 631 / 632 / 635 / 636
Fax: 0120 - 3008643 / 45 / 48 / 49 / 50

Workshop 2 :

58/3, Site 04, Sahibabad, Ghaziabad - 200 300
Tel. : 0120 - 4558765

196 Service Network

- ★ **JHANSI**
Sri Venkateshwar Autocare Pvt. Ltd.
Showroom & Workshop :
Jhansi Kanpur Road, Goramachhiya, Jhansi - 284 001
Tel. : 0510 - 2371144, 6450158
- ★ **KANPUR**
Cross Road Auto Pvt. Ltd.
Showroom :
40, Government Industrial Estate,
Opp. Sindh Colony, Fazal Ganj, Kanpur - 208 012
Tel.: 0512 - 2221276 / 2220043
- Workshop 1 :**
C-15A, Panki Industrial Area, Site-1, Kanpur - 208 012
Tel.: 0512 - 2691293, 2691377
- Workshop 2 :**
122/236, A-1 & C-1, Fazalganj,
Near Sangam Talkies, Kanpur - 208 012
Tel.: 8009461111
- ★ **Romi Motors Pvt. Ltd.**
Showroom :
14/63, Civil Lines, Kanpur - 208 001
Tel.: 0512 - 3224703
- Workshop :**
120/192 (4), Lajpat Nagar,
Near Mariampur Crossing, Kanpur - 208 012
Tel. : 0512 - 3224701 / 3224702
- ★ **LUCKNOW**
Megha Auto (I) Pvt. Ltd.
Showroom & Workshop :
10/CP/5, Ring Road, Vikasnagar,
Opp. Jagrani Hospital, Lucknow - 226 020
Tel. : 0522 - 4057999 / 4007977 / 2330180
- Workshop 2:**
Mishipur Depot, Near Sanatan Cold
Storage, Kursi Road, Lucknow - 226 026
Tel. : 0522 - 2890631
- ★ **MEERUT**
Vardajyoti Automobiles Pvt. Ltd.
Workshop :
Madhuban Cinema Bldg., Madhuban Colony,
Baghpath Road, Meerut - 250 002
Tel. : 0121 - 2404005 - 08
Fax : 0121 - 2404009

- ★ **MORADABAD**
Sigma Motors Pvt. Ltd.
Showroom & Workshop :
Near Radhakrishna Mandir,
Delhi Road, Moradabad - 244 001
Tel. : 0591 - 2550100 - 05, 7351007701 - 05,
7351003805

- ★ **MIRZAPUR**
Saraswati Industries
Showroom & Workshop :
Pili Kothi, Station Road, Mirzapur - 231 001
Tel. : 05442 - 223923

- ★ **NOIDA**
Shiva Motors
Showroom :
G-24, Sector 11, Noida - 210 301
Tel. : 0120 - 3920150 / 158

- Workshop :**
C-80/81A, Sector - 8, Noida
Tel. : 0120 - 3359807 / 813

- ★ **SAHARANPUR**
DPM Autosales
Workshop :
Ambala Road, Near Badi Nahar, Saharanpur
Tel. : 0135 - 2640877

- ★ **VARANASI**
Vinayak Automotive Pvt. Ltd. (Vinayak Chevrolet)
Showroom & Workshop :
Adjacent to Essar Petrol Pump,
Jagatpur, Rohania, Varanasi - 221 313
Tel. : 7703003320, 7703003330, 7703003321,
7703003333

STATE - UTTARAKHAND

- ★ **DEHRADUN**
DPM Autosales
Showroom & Workshop :
Mohabewala Industrial Area,
Saharanpur Road, Dehradun
Tel. : 0135 - 2642051 / 52 / 53
Fax : 0135 - 2642054

- ★ **HALDWANI**
M/s Sidhbal Automobiles Pvt Ltd
Showroom & Workshop :
Jeetpur Negi, Rampur Road,
Haldwani - 263139
Tel. : 18008432345, 7055711120

STATE - JAMMU & KASHMIR

- ★ **JAMMU**
K. C. Motors
Showroom & Workshop :
NH-1, Bypass Road, Jammu - 180 004
Tel. : 0191 - 2465769 / 59, 2460829
Fax : 0191 - 2476660

- ★ **SRINAGAR**
K. C. Motors
Showroom & Workshop :
By Pass Road, Hyderpora, Srinagar - 190 014
Tel. : 0194 - 2443188

WEST ZONE

STATE - GOA

- ★ **VASCO-DA-GAMA**
Subrai Motors Pvt. Ltd.
Workshop :
F L Gomes Road, Vasco-Da-Gama, Goa - 403 802
Tel. : 0832 - 2517421 / 22
Fax : 0832 - 2513924

STATE - GUJARAT

- ★ **AHMEDABAD**
Gallops Motors Pvt. Ltd.
Showroom & Workshop :
Near JCB Service Station, S.G. Highway,
Sarkhej, Ahmedabad - 380 015
Tel. : 079 - 2474346, 39835544, 39835501
Fax : 079 - 39835588
- Showroom 2 :**
A/8,9,10,11,12,13 & 14, Radhe Shopping Mall,
Khokhra, Maninagar, Ahmedabad
Tel. : 079 - 32941862 / 32440235
- Workshop 2 :**
Opp. Amraivadi Post Office, Near Hatkeswar Circle,
Maninagar, Ahmedabad - 380 026
Tel. : 079 - 30486501 / 02 / 03
- ★ **ANAND**
Shree Gopinathji Agencies
Workshop :
Survey No. 570 - A/2, Near Indira Statue,
Lambhavel Road, Anand - 388 001
Tel. : 02692 - 247979 / 247878
- ★ **BARDOLI**
Empire Cars Pvt Ltd
Showroom & Workshop :
Near Hero Corp Showroom, Nadiad Chowkdi,
Bardoli Surat Road, Bardoli - 394601
Tel. : 9879560001

- ★ **BHARUCH**
Shree Gopinathji Agencies
Showroom & Workshop :
Beside K.U & Company Petrol Pump,
NH-8, Village Vadadala, Bharuch - 392 015
Tel. : 02642 - 654245, 291303, 654845
Telefax : 02642 - 231584

- ★ **BHAVNAGAR**
V Raj Motors
Showroom & Workshop :
Plot No. 150, Near Press Quarter,
Opp. Maruti Showroom, Bhavnagar-Rajkot Road,
Chitra, Bhavnagar - 364 003
Tel. : 0218 - 2444590, 2444445

- ★ **BHUJ**
Cargo Motors
Showroom & Workshop :
Plot No. 10, Survey No. 29/1,
Bhuj - Mirzapur Road, Bhuj - 370001
Tel. : 02832 - 654191 / 654192

- ★ **GANDHIDHAM**
Cargo Motors
Showroom & Workshop :
NH-8A, Kandla Port Road, Gandhidham - 370 201
Tel. : 02833 - 654370, 653317, 9825611692

- ★ **GODHRA**
Shree Gopinathji Agencies
Showroom & Workshop :
Moonlight Cinema Compount, Vavdi,
Godhra - 389 001
Tel. : 02672 - 645828, 265270, 265271

- ★ **GANDHI NAGAR**
Gallops Motors Pvt. Ltd.
Showroom & Workshop :
Near Nigam Petrol Pump, Rajshree Cinema Road,
Sector-21, Gandhinagar - 382 010
Tel. : 0232 - 30516107

- ★ **HIMMATNAGAR**
Gallops Motors Pvt. Ltd.
Showroom & Workshop :
Near Motipura Circle, Opp. S.T. Workshop,
Shamlaji Highway, Himmatnagar - 383 001
Tel. : 02772 - 229525, 229524, 308000, 308001

- ★ **JAM NAGAR**
Gallops Motors Pvt. Ltd.
Showroom :
Jamnagar - Rajkot Highway, Hapa,
Opp. Tata IB Motors, Jamnagar
Tel. : 0288 - 3216060

- Workshop :**
Jamnagar to Rajkot Highway, 8 - Happa,
Jamnagar - 320 120
Tel. : 0288 - 3921194 - 98

- ★ **MEHSANA**
Gallops Motors Pvt. Ltd.
Showroom & Workshop :
Opp. Wide Angle, Nagalpur Highway,
Mehsana - 384 002
Tel. : 02762 - 241010, 302401 / 02 / 06
Fax : 02762 - 245151

- ★ **NAVSARI**
Monarch Motors
Showroom & Workshop :
Mahalaxmi Estate, Near Bhana Petrol Pump,
Near Grid Char Rasta, N.H. No. 8, Navsari - 396 424
Tel. : 02637 - 265788 / 265599

- ★ **PALANPUR**
Gallops Motors Pvt. Ltd.
Showroom & Workshop :
Survey No. 525/1, Palanpur - Delhi Highway,
Near Palanpur - Deesa Char Rasta, Palanpur - 385 001

- ★ **RAJKOT**
Gallops Motors Pvt. Ltd.
Showroom & Workshop :
Survey No. 219/220, Opp. Parin furniture,
Next to Jay Ganesh, AT & PO,
Kotharia Gondal Highway, Rajkot - 360 003
Tel. : 0281 - 3205151, 2370006 / 8 / 9 / 10,
3983400, 3983407

- ★ **SURAT**
Empire Cars Pvt. Ltd.
Showroom & Workshop :
Plot No. 3, Near Rangoli Hotel, Rundh,
Dumas Road, Surat - 395 007
Tel. : 0261 - 6713300 / 33

198 Service Network

★ **Monarch Cars Pvt. Ltd.**

Showroom:

Umia Nagar Society,
Near Shree Choshath Joganiya Mata Mandir,
Udhna Magdalla Road, Surat - 394 210
Tel.: 0261-2720481, 2720482, 09825274707

Workshop :

Next To Sameeti School, Patel Nagar Circle,
Udhna Gam, Surat - 394 210
Tel.: 0261 - 3091001

★ **Nanavati Motors**

Showroom:

Orchid Tower, Opp Intercity Township,
Puna Kumbharia road, Surat - 395 010
Tel.: 9879114447

Workshop :

Opp. SBI Bank, Puna Patiya,
Puna Kumbharia Road, Surat - 395 010
Tel. : 0261 - 6456449/429/430
Fax : 0261 - 2647771

SURENDRA NAGAR

★ **Gallops Motors Pvt. Ltd.**

Workshop :

Plot No. 267, GIDC Vadhan, Opp. Market Yards,
Near Rekha Bearings, Surendra Nagar
Tel. : 02752 - 321542 - 43

VAPI

★ **Desai Automobiles**

Showroom & Workshop :

At & Po : Balitha, Near Woodland Hotel,
National Highway No. 8,
Taluka Pardi, Vapi, Valsad - 395 015
Tel. : 0260 - 6531783, 2400250 - 51
Fax : 0260 - 2426525

VADODARA

★ **Shree Gopinathji Agencies**

Showroom & Workshop :

Opp. Gujarat Elec. Board Sub Station,
(Near Prakuti Resort), Chhani, Baroda - 390 002
Tel. : 0265 - 2761105 / 06

Showroom & Workshop 2 :

R. S. No. 7, Opp. Atladra Railway Station,
Atladra, Vadodara - 390 012
Tel. : 0265 - 2681050, 1060, 0187, 1010, 1020
Fax : 0265 - 2681050, 2354984

Showroom & Workshop 3 :

3/A, Sahajanand Industrial Estate,
Munjmahuda, Akota, Vadodara - 390 020
Tel. : 0265 - 2681010, 2681020, 2359898, 2334109
Fax : 0265 - 2681050, 2681060

STATE - MADHYA PRADESH

BHOPAL

★ **Super Cars Ltd.**

Showroom & Workshop :

Plot No. 21 Sector G, Govindpura Industrial Area,
J.K. Road, Bhopal - 462 021
Tel. : 0755 - 4028400, 4228201
Fax : 0755 - 4228203

★ **Varenayam Motors**

Showroom & Workshop :

189, Angoori Bagh, Jinsi Road, Bhopal - 462 008
Tel. : 0755 - 2575288 / 299 / 300
Fax : 0755 - 2579918

CHHINDWARA

★ **Sunshine Motors**

Showroom & Workshop :

College Road, Lalbagh, Chhindwara - 480 001
Tel. : 0716 - 244125, 244129, 244193 / 194
Fax : 0716 - 244126

GWALIOR

★ **Sumedha Vehicles Pvt. Ltd.**

Showroom & Workshop :

Opp. Jhansi Road Police Station,
Jhansi Road, Gwalior - 474 009
Tel. : 0751 - 2422067, 4015789, 3291856
Fax : 0751 - 2348024

INDORE

★ **Super Cars Ltd.**

Showroom :

Saket Tower - 3A, Ratlam Kothi,
Near Geeta Bhavan Square, AB Road, Indore - 452 001
Tel. : 0731 - 4700053, 54
Telefax : 0731 - 4700052

Workshop :

49, United Compound, Iasudiya Mori,
Dewas Naka, Indore
Tel. : 0731 - 470055, 56, 57
Fax : 0731 - 470054

★ **Chhabra Autolink Pvt. Ltd.**

Showroom :

Plot No.-10 Vishnupuri Main, Near Medisquare
Hospital, Indore - 452001
Tel : 0731- 4267800

Workshop :

Plot No.- 11/11,11/12, Survey No.- 26, Gram Palada,
Khandwa Road, Indore - 452011
Tel : 0731 - 6656000

★ **JABALPUR**

Oriental Motors

Showroom & Workshop :

497, Karmeta, Near Padwar Kala,
Katangee Bye Pass Road, Jabalpur - 482 003
Tel. : 0761 - 3250007, 3260002, 3250003, 3290001
Fax : 0761 - 4027011

KHANDWA

★ **Bedi Motors**

Showroom & Workshop :

Gram Kehmapur, Indore Road, Khandwa - 450 001
Tel. : 0733 - 2244075

RATLAM

★ **Super Cars Ltd.**

Showroom & Workshop :

Jaora Road, Near RTO Office, Ratlam - 457 001
Tel. : 07412 - 260040

SAGAR

★ **Varenayam Motorcars Pvt. Ltd.**

Showroom :

Opposite Hotel Paradise, Jabalpur Road, Makroniya,
Sagar - 470 004
Tel. : 07582 - 263566

Workshop :

Behind HDFC Bank, Makroniya
Sagar - 470 004
Tel. : 07582 - 239288

SATNA

★ **Oriental Motors**

Showroom :

Virat Nagar Colony, Pateri, Panna Road, Satna - 485 001
Tel. : 07672 - 229495

Workshop :

27, Industrial Area Near Union Floor, Rewa Road,
Satna - 485 001
Tel. : 7672 -252763

STATE - MAHARASHTRA

AHMEDNAGAR

- * **Saideep Cars Pvt. Ltd.**

Workshop :

Survey No. 55/1B/2/1, Nagar Manmad Road,
Ahmednagar - 414 111
Tel. : 0241 - 2779225 - 7
Fax : 0241 - 2779228

AKOLA

- * **Star Motors**

Showroom & Workshop :

9/1, Geeta Nagar Near, Alankar Petrol Pump,
Akola - 444 005
Tel. : 07242800087 / 7350008428

AMRAVATI

- * **Star Motors**

Showroom & Workshop :

Plot No. 8, Navathe Square Bandnera Road, Amravati
Tel. : 0721 - 2510199, 9921008861, 7350008426

AURANGABAD

- * **Mishrikotkar Motors LLP (Arihant Chevrolet)**

Showroom :

Sector P, Town Centre, Jalna Road, CIDCO,
Aurangabad - 431 005
Tel. : 0240-2482819

Workshop :

Plot No.E-35, Chikalthana MIDC Area,
Aurangabad - 431 006
Tel. : 7745011919, 7745021919

BARAMATI

- * **Mota Automotive Pvt. Ltd.**

Showroom & Workshop :

41 / 1 / B / 17, Nira Road, Kasba, Tehsil - Baramati,
Dist - Pune - 413 102
Tel. : 02112 - 222212, 220212

CHANDRAPUR

- * **ND Cars Pvt. Ltd.**

Showroom & Workshop :

Gajanan Maharaj Mandir Square, Bapat Nagar,
Nagpur Road, Chandrapur - 442 401
Tel. : 07172 - 646344/22

DHULE

- * **Jitendra Wheels Pvt. Ltd.**

Showroom & Workshop :

P-62, Behind Hotel Manas, MIDC Avdhan,
Dhule - 424 001
Tel. : 02562 - 281222 / 232

JALGAON

- * **Soham Motors Pvt. Ltd.**

Workshop :

93/1, MIDC, RL Square Aurangabad Road,
Jalgaon - 425 003
Tel. : 0257-2211151, 2270085

KOLHAPUR

- * **Unique Automobiles**

Showroom & Workshop :

122/1, Pulachi Shirol, Opp. Sangli Phata,
Kolhapur - 416 122
Tel. : 0230 - 2461518 - 19
Fax : 0230 - 2461520

Showroom 2 :

Ayodhya Park, Opp. Sangam Talkies,
Kavala Naka, Kolhapur - 416 001
Tel. : 0231 - 2535315, 2535425
Fax : 0231 - 2535615

LATUR

- * **Ajinkya Cars Pvt. Ltd.**

Showroom & Workshop :

Barshi Road, Near Bidave Engineering College,
Beside Pramod Petrol Pump, Latur - 413 531
Tel. : 02382 - 222600

MUMBAI

- * **Ashtavinayak Auto Pvt. Ltd.**

Showroom 1 :

D Mall, Off Veera Desai Road, Andheri (West),
Mumbai - 400 053
Tel. : 022 - 66488888
Fax : 022 - 66488880

Showroom 2 :

Shop no. 1 & 2, Poonam Heights Building,
SV Road, Goregaon West, Mumbai - 4000062
Tel. : 022 - 67822288

Workshop :

Ram Mandir Road, Somani Gram,
Next to Central Warehouse Corporation,
Oshiwara, Goregaon (West), Mumbai - 400 051
Tel. : 022 - 26765555

- * **AVK Automart Pvt. Ltd.**

Workshop :

Fida Hussain Industrial Estate,
Near Samrat Hotel, Pandurang Wadi Road,
Mira Road (West), Mumbai - 401 104
Tel. : 022 - 28453178, 28455507, 28453564

- * **Nikhil Automobiles Pvt. Ltd.**

Showroom & Workshop 1 :

A 70, TTC Industry Area, Thane Belapur Road,
Kharghar, Near ICI Color Company,
Khoparkhane West, Navi Mumbai - 400 709
Tel. : 022 - 27780801, 40708888
Fax : 022 - 40708899, 27780805

Showroom 2 :

264-265, Vaswani Chambers, Opp. Old Passport
Office, Prabhadevi, Mumbai - 400 025
Tel. : 022 - 434594444, 24221711-12
Fax : 022 - 24222713

Workshop 2 :

C/o Bharat Tiles & Marbles Ltd.,
Jaibhimnagar, Dharukhana Road, Reay Road (East),
Near Sujala Hotel, Mumbai - 400 010
Tel. : 022 - 64560303, 23774514 / 15 / 16
Fax : 022 - 23774505

Workshop 3 :

Plot No. D - 238 - A, TTC Industrial Area,
MIDC Shiravane, Nerul, Navi Mumbai - 400 706
Tel. : 022 - 43448800

NASIK

- * **Jitendra Wheels Pvt. Ltd.**

Showroom & Workshop :

B-88, Arihant Plaza, MIDC, Ambad, Next to Hotel Taj,
Mumbai - Agra Highway, Nasik - 422 010
Tel. : 0253 - 2384432 / 632 / 832, 6636666, 6637777
Fax : 0253 - 2384532

200 Service Network

- ★ **NAGPUR**
Star Motors
Showroom & Workshop :
44 / 4, Wahajara, Kamptee Road,
NH - 7, Nagpur - 440 026
Tel. : 0712 - 6507836/37, 6507916, 6461503 / 04
Fax : 0712 - 2632429
- ★ **Tajshree Motors Pvt. Ltd.**
Showroom :
Plot No. 1 Hindustan Colony, Wardha Road,
Nagpur - 440 002
Tel. : 0712 - 2250242 / 2250243 / 2250244
- Workshop :**
Plot No. 679, Ghat Road,
Near Cotton Market Square, Nagpur - 440 018
Tel. : 0712 - 2734466 / 2734467
- ★ **NANDED**
Bafna Automotives
Workshop :
Gut No. 235, Pimpalgaon (Mahadeo),
Nanded -Akola Road, Nanded - 431 607
Tel. : 02462 - 274069 / 652099, 311102
- PUNE**
- ★ **Platinum Chevrolet**
Showroom & Workshop 1 :
Sr No 45/1/B/A, Shankarseth Road, Gutkewadi,
Pune - 411 037
Tel. : 020 - 26440029
- Showroom & Workshop 2 :**
Survey No 5/4, Najhate Nagar, Kalewadi Main Road,
Thergaon, Pune - 411 033
Tel. : 020 - 66326600, 66326632, 66326666
- ★ **Singh Cycle & Motor Co.**
Showroom 1 :
S. No. 38/4, Krishna Complex, Hadapsar Bypass
Road, Near Radisson Hotel, Kharadi, Pune - 411 014
Tel. : 020 - 32419385 / 32319526
- Showroom 2 :**
ICC Trade Centre, Showroom No. 4, Survey No. 403
A/2, Senapati Bapat Road, Pune - 411 016
Tel. : 020 - 25666941 / 2 / 3 / 4

- Workshop 1 :**
Reality Warehousing Pvt. Ltd., Gate No. 1337 / 1,
Pune Nagar, Wagholi, Pune - 412 307
Tel. : 020 - 46609999
- Workshop 2 :**
Patel Tiles Compound, Sr.No. 42/1, Shivaji Nagar,
Behind ST Bus Stand, Pune - 411 005
Tel. : 020 - 32424202, 65270809, 7774010500
- ★ **Pethkar Motors Private Limited**
Showroom :
Sr No- 130, Audumber,
Near Vardhman Petrol Pump, NH - 4, Warje
Pune - 411052
- Workshop :**
Sr. No - 320, Hissa No - 1/A
Opp. Chellaram Diebetes Centre, Bavdhan BK
Pune - 411021
- ★ **SATARA**
Unique Automobiles
Showroom & Workshop :
41, Mutha Colony, Sadar Bazar, Satara - 416 002
Tel. : 09623225299
- ★ **SOLAPUR**
Mota Automotive Pvt. Ltd.
Workshop :
MRC Cable India, A/20/6, MIDC Chincholi,
Solapur - 413 255
Tel. : 927222233
- ★ **SANGLI**
Unique Automobiles
Showroom :
442-3, Kulkarni Complex, 100 feet road,
South Sivaji Nagar, Sangli - 416 416
Tel. : 0233 - 2326544
Fax : 0233 - 2326594
- Workshop :**
Kulkarni Complex, 100 Feet Road,
Near MSEB Sub-Station, Sangli - 416 416
Tel. : 0233 - 2326544
Fax : 0233 - 2326594

- ★ **YAVATMAL**
SARAS MOTORS
Pobaru Marketing & Agencies Pvt. Ltd.
Showroom :
Shop No. 5, 6, 7, 8 Udhog Bhavan,
Dharwaha Road, Yavatmal - 445 001
Tel. : 07232 - 255991
Fax : 07232 - 255992
- Workshop :**
Block No. B-16 MIDC (Lohara), Yavatmal - 445 001
Tel. : 07798883816
Fax : 07232 - 255992
- THANE**
- ★ **SC Auto Corporation**
Showroom:
Modi House, Opp. to LIC Building, Naupada,
Eastern Express Highway, Thane (West),
Thane - 400 602
Tel. : 022 - 67610000
Fax : 022 - 67610209
- Workshop :**
Pioneer Estate Corporation, 133-134, Pokhran Road
No.2, Opp. Oswal Park, Thane (West) - 400601
Tel. : 022 - 66040000
Fax : 022 - 66040102
- ★ **Angel Auto World Pvt. Ltd.**
Showroom & Workshop 1 :
Grishma garden, Gokhivare, Vasai East, Thane,
Mumbai (Vasai) - 401208
Tel :0250-6453030 /6061777
- Showroom & Workshop 2 :**
J-176, MIDC, Tarapur Road,
Boisar (West) - 401505
Tel. : 02525 - 655454 / 655353
- ★ **Nikhil Automobiles Pvt. Ltd.**
Showroom & Workshop :
Survey No. 6, Hissa No. 6, Manpada Gaon,
Kalyan Shill Road, Dombivali (East) - 421 204.
Tel. : 0251 - 3048888 / 3048899

STATE - CHATTISGARH

BILASPUR

- * **Swati Ventures**
Showroom & Workshop :
Besides Shiv Talkies, Old Bus Stand Road,
Bilaspur - 495001
Tel. : 7752 - 605500 / 605511

RAIPUR

- * **Vardhaman Motors**
Showroom & Workshop :
9/1, Mahoba Bazar, GE Road, NH-6,
Kumhari Dist. - Durg, Raipur - 492 001
Tel. : 7489177999, 7883221999

Showroom 2 :

Ashoka Millenium, Ring Road,
Raipur - 492 011
Tel. : 7714030104, 7712410008

202 Service Network

SOUTH ZONE

STATE - ANDAMAN & NICOBAR

- PORTBLAIR**
* **Group Engineers**
Showroom :
Prem Nagar Junction, (SY No 1394/1),
Haddo Post Port Blair - 744 102
Tel. : 03192 - 230301, 242901

Workshop :
Opp Womens Working Hostel, Dollygunj,
Port Blair, Junglight Post, Portblair - 744 103
Tel. : 03192 - 253044 / 253011

STATE - ANDHRA PRADESH

- BHIMAVARAM**
* **Orange Auto Pvt. Ltd.**
Showroom & Workshop :
Door No. 2-25, # 6, Near Bharath petroleum bunk,
Undi Road, Bhimavaram - 534 202
Tel. : 9052781234 / 905224678
- CHITTOOR**
* **M.G. Brothers Automobiles (P) Limited**
Showroom & Workshop :
NH 4, Near Iruvaram Check Post, Chittoor - 517 001
Tel.: 92470 00003, 9247000027
- GUNTUR**
* **Fusion Motors**
Showroom & Workshop :
Plot No. 296 & 297, Opp. Sarvani Diesel Enginnering,
Autonagar Main Road, Autonagar, Guntur - 522 001
Tel. : 0863 - 6454545
- KURNOOL**
* **Dheeraj Motors**
Workshop :
NH-7 Road, Near APSP 2nd Battalion,
Ballary Chowrasta, Kurnool - 518 004
Tel. : 8518 - 253777

- NELLORE**
* **M.G. Brothers Automobiles (P) Limited**
Showroom:
26-2-1777, Near Ayyappa Temple, Vedayapalem Area,
Nellore - 524 004
Tel.: 9247000000

Workshop :
Plot No. 95 & 96, Wood Complex,
Near Ayyappa Temple, Nellore - 524 004
Tel. : 9247000022

- RAJAHMUNDRY**
* **Orange Auto Pvt. Ltd.**
Showroom & Workshop :
D. No. 82-10-2, Venkateswara Nagar,
Near Lalacheruvu, Near ONGC Complex, NH-5 Road,
Rajahmundry - 533 103
Tel. : 0883 - 6575555 / 6580888

- TIRUPATHI**
* **M.G. Brothers Automobiles (P) Limited**
Showroom:
11-46/A, Renigunta Road, Tirupathi - 517 501
Tel.: 9299999970

Workshop :
Plot No: 254, Auto Nagar,
Near Vinayaka Temple, Renigunta Road,
Tirupathi - 517 506
Tel.: 9247000024

- VISHAKHAPATNAM**
* **Orange Auto Pvt. Ltd.**
Showroom & Workshop :
D. No.38-22-87, Varun Avenue, NH-5, Murali Nagar,
NH. Birla Junction, Vishakhapatnam - 530 075
Tel.: 0891 - 2572222, 9052402345

Showroom 2 :
D. No. 4-46-12, G. K. Mansiom, Pedawaltier,
Vishakhapatnam - 530 017
Tel.: 0891 - 2572222, 4444
Fax: 0891 - 6645555

- VIJAYWADA**
* **Fusion Motors**
Showroom :
Fusion Towers, 36-12-2, Opposite to Siddhartha
Public School, Moghul Rajapuram,
Vijayawada - 520 010
Tel. : 0866 - 6645555 / 9603123666
Fax : 0866 - 6645592

Workshop :
Opposite to Fusion Towers, 36-12-2,
Near Siddhartha Public School, Moghul Rajapuram,
Vijayawada - 520 010
Tel. : 0866 - 6645593 / 94, 9603123777

STATE - KARNATAKA

- BANGALORE**
* **Kropex India Ltd.**
Showroom & Workshop :
49/1, Singasandara, Hosur Main Road,
Bangalore - 560 068
Tel. : 080 - 43574357
Fax : 080 - 43574353
- Workshop 2 :**
Sy, No. 26, Hanumareddy Layout,
Chinnapanahalli Main Road, Marathahalli Post,
Bangalore - 560 037
Tel. : 9663388812
- * **Trident Automobiles Pvt. Ltd.**
Showroom & Workshop :
No. 122/1, C. Shankar Reddy Layout, Kalyana Nagar,
Outer Ring Road, Bangalore - 560 043
Tel. : 080 - 43430300, 43430500
Fax : 080 - 43430308, 43430517

Showroom 2 :
No. 300 A - 70, 36th Cross, 10th Main,
5th Block, Jay Nagar, Bangalore - 560 041
Tel. : 080 - 42542999

Workshop 2 :
No. 558/1,60 ft Road, 9th Cross, HAL 2nd Stage,
Old Airport Road, Behind Leela Palace,
Kodihalli, Indiranagar, Bangalore - 560 008
Tel. : 080 - 49155858

* **K.H.T. Chevrolet (A Division Of Morzaria Real Tech Private Limited)**
Showroom :
 No: 725, West of Cord Road, Rajajinagar,
 1st Stage, Mahalakshmi Layout, Bangalore - 560 008
 Tel. : 080 - 49363636

Workshop :
 No. 305, 5th Main Road, 2nd Cross, 4th Phase,
 Peenya Industrial Area, Bangalore - 560 058
 Tel. : 080 - 49353637

* **BELGAUM**
Bellad Enterprises Pvt. Ltd.
Showroom & Workshop :
 Shri Krishna Weaving Mill Compound,
 Venguaral Road, Vijaya Nagar, Belgaum - 591 108
 Tel. : 0831 - 2449556 / 557, 6514911
 Fax : 0831 - 2472209

* **BELLARY**
Bellad Enterprises Pvt. Ltd.
Showroom & Workshop :
 Near Bellary Rolling Mills, Anantpur Road,
 Bellary - 583 101
 Tel. : 08392 - 261234 / 5
 Fax : 08392 - 261235

* **DAVANGERE**
Modi Motors
Showroom & Workshop :
 #869/1-2, PB Road, Opposite Sai International Hotel,
 Davangere - 577 006
 Tel. : 08192 - 233896

* **GULBARGA**
VKG Motor World
Showroom & Workshop :
 Plot - 1&2, Survey No. 116/2, Behind Mahendrakar
 Complex, Kapnoor Humnabad Road,
 Gulbarga - 585104
 Tel. : 08472 - 224555
 Fax : 08472 - 258019

* **HUBLI**
Bellad Enterprises Pvt. Ltd.
Showroom & Workshop :
 Opp. NGEF, Rayapura, Dharwad,
 P. B. Road, Hubli - 580 025
 Tel. : 0836 - 2218338 / 39
 Telefax : 0836 - 2218337

* **MANGALORE**
Vibrant Motors
Showroom:
 Mont Tiera Apartments, Vivekanand Road,
 Kadri, Nantoor-Padav, Mangalore - 575004
 Tel.: 0824 - 2225544

Workshop :
 C/O Manjunath Retreading Works, Kulshekara
 Chowki, Near KMF Milk Dairy, Kulshekar,
 Mangalore - 575 005
 Tel. : 0824 - 2231202

* **MYSORE**
Dyuthi Motors Pvt. Ltd.
Showroom & Workshop :
 No. 201 / 1 & 2, Hunsur Road, Hinkal Village,
 Mysore - 570 017
 Tel. : 0821 - 4240500 - 16
 Fax : 0821 - 4241899

STATE - KERALA

* **ALLEPPEY**
Geeyam Motors Pvt. Ltd.
Showroom :
 Koorayil Annex, Opp. Bhattathiripurayidom,
 Near MCH Junction, Alappuzha, Alleppey - 688 001
 Tel. : 0477 - 2238501

* **CALICUT**
German Motors
Showroom & Workshop :
 118-A, Chungam Junction, West Hill,
 Calicut - 673 005
 Tel. : 0495 - 2383680 / 81, 2383770 / 71
 Fax : 0495 - 3041100, 2381909

* **COCHIN**
Geeyam Motors Pvt. Ltd.
Showroom & Workshop :
 11/336, NH-47 Bye Pass, Nettor P.O.,
 Ernakulam, Cochin - 682 304
 Tel. : 0484 - 2703245 - 49, 3097100, 3097101
 Fax : 0484 - 2703244

* **KANJRAPALLI**
Geeyam Motors Pvt. Ltd.
Showroom :
 Near A K J M School, K K Road, Kanjirappally
 (Kottayam Dt.)
 Tel. : 0482 - 8201616

* **KANNUR**
German Motors
Showroom & Workshop :
 BP6-14A, Valappattanam, Kannur - 670 010
 Tel. : 0497 - 2774466 - 67, 3057200
 Fax : 0497 - 27744666, 3057200

* **KAYAKULAM**
Geeyam Motors Pvt. Ltd.
Showroom & Workshop :
 NH-47, Near MSM College, Kayakulam - 690 502
 Telefax : 0479 - 2446650

* **KODANGULUR**
Geeyam Motors Pvt. Ltd.
Showroom :
 XII/ 121-122, Opp. Medicare Hospital,
 Kottapuram PO, TKS Puram, Kodungalur - 680 667
 Tel. : 0480 - 2803561 / 62

* **KOTAYYAM**
Geeyam Motors Pvt. Ltd.
Showroom & Workshop :
 Karithas Junction, Thellakom P.O., Kotayyam-686016
 Tel. : 0481 - 2792203
 Fax : 0481 - 2792383

* **KOLLAM**
Deedi Motors
Showroom :
 Post Office Junction, Pallimukku, Kollam - 691 010
 Tel. : 0474 - 3257777 / 2725959
 Fax : 0474 - 2725900

Workshop :
 Cantonment, North Nagar, Pullikada, Kollam - 691001
 Tel. : 0474 - 2750010 / 11

* **KOTTAKKAL**
German Motors
Showroom & Workshop :
 260A, Palathara, Cherusola P.O., Kottakkal,
 Malappuram
 Tel. : 0494 - 2611666

204 Service Network

- * **MUVATTUPUZHA**
Geeyam Motors Pvt. Ltd.
Showroom :
Mackar Plaza, EEC Market Road, PNB Junction,
Muvattupuzha - 686 673
Tel. : 0485 - 606600, 2835272 / 73
Fax : 0485 - 2832554
- Workshop :**
902/903, Opp. Mackar Plaza, EEC Market Road,
PNB Junction, Muvattupuzha - 686 673
Tel. : 0485 - 2835272 / 73
Fax : 0485 - 2832554
- * **MUTTUM**
Geeyam Motors
Showroom & Workshop :
SY NO: 70/15, 71/10, Thai Kkattukara P.O, N H Road,
Distt. Aluva, Muttum, Cochin - 683 106
Tel. : 0484 - 2632193 / 94 / 95 / 96 / 97
- * **PERINTHALMANNA**
German Motors
Showroom & Workshop :
AP-IV 664E, Opp. ITC, Tirurkad,
Perinthalmanna - 679 531
Tel. : 04933 - 325060, 237000, 239878
Telefax : 04933 - 2737000
- * **PALAKKAD**
Geeyam Motors
Showroom & Workshop :
Door No. 8/1198, NH Bypass Road,
Chandra Nagar, Palakkad - 678 007
Tel. : 0491 - 2504133
Fax : 0491 - 2504143
- * **PATHANAMTHITTA**
Deedi Motors Pvt. Ltd.
Showroom & Workshop :
Kumbazhethu Buildings, Churulicode P.O.,
Kozhencherry Road, Pathanamthitta - 689 645
Tel. : 0468 - 2272079, 2272080
Fax : 0468 - 2272078

- * **THIRUVALLA**
Deedi Motors Pvt. Ltd.
Showroom :
No. 54/2, Kurusumoottil Buildings,
M C Road, Mazhuvangad, Thiruvalla - 689 101
Tel. : 0469 - 2740800

- * **THRISSUR**
Geeyam Motors Pvt. Ltd.
Showroom :
14/3-A1, Guruvayoor Road Puzhakkal,
Ayyanthole P.O., Thrissur - 680 003
Tel. : 0487 - 2388945 - 46, 2388851 - 52
Fax : 0487 - 2388851

- Workshop :**
Near Boating Station, Puzhakkal Post Office,
Thrissur - 680 553
Tel. : 0487 - 2225100, 2225101

- * **TRIVENDRUM**
Deedi Motors Pvt. Ltd.
Showroom / Workshop :
Erumalathopu, N.H. Bye Pass Road, Venpalvattom,
Anayara P.O., Trivendrum - 695 029
Tel. : 0471 - 2556006, 3257777, 2558599, 2558499
Fax : 0471 - 2551020

- * **WAYNAD**
German Motors
Showroom / Workshop :
Muttill - Post, North Kalpetta, Waynad - 673 122
Tel. : 04936 - 304200 / 202414
Fax : 04936 - 304201

STATE - PONDICHERY

- * **PONDICHERY**
Aakash Auto Pvt. Ltd.
Showroom :
No. 1, Sounderrajan, 100 ft. Road, Sounder Rajan
Nagar, Mudaliarpet, Pondicherry - 605 004
Tel. : 0413 - 2204400
Fax : 0413 - 2204033

- Workshop :**
No. 23, 9th Cross, Metupallyam,
Industrial Estate, Pondicherry - 605 009
Tel. : 0413 - 2279900

STATE - TAMIL NADU

- * **CHENNAI**
Sundaram Motors
Showroom & Workshop :
180, Anna salai Road, Chennai - 600 006
Tel. : 044 - 28579203 / 28 / 32
Fax : 044 - 28579210

- Workshop 2:**
116/4 Mahalakshmi Nagar Exention,
Numbal Village Thirverkadu Post, Chennai - 600 077
Tel. : 044 - 26493020/21

- * **KLN Motors Agencies Pvt. Ltd.**
Showroom 1 :
Old No. 861, New No. 232, Poonamallee High Road,
Kilpauk, Chennai - 600 010
Tel. : 044 - 23452937 / 38
Telefax : 044 - 23452936

- Workshop 1 :**
Shop No. 50, SIDCO Industrial Area,
Ambattur, Chennai - 600 058
Tel. : 044 - 23452930 - 32

- Showroom & Workshop 2 :**
No. 8-NP, Developed Plot, Guindy Industrial Estate,
Ekkattuthangal, Near Kasi Theatre, Chennai - 600 097
Tel. : 044 - 23458941 / 42

- * **CUDDALORE**
Aakash Auto Pvt. Ltd.
Showroom & Workshop:
RS No.155/11, Vadalaru Main Road, Periamedu,
Karaiakadu Village, Cuddalore Taluk,
Cuddalore - 607 005
Tel.: 04142 - 297997, 7373299933, 7373599933

- * **COIMBATORE**
Anamallais Agencies (P) Ltd.
Showroom :
252, Mettupalayam Road, Coimbatore - 641 043
Tel. : 0422 - 2435555 / 2432999
Fax : 0422 - 2446151

Workshop :

249A, Mettupalayam Bye Pass Road,
Coimbatore - 641 043
Tel. : 0422 - 2433444

* **Pressana Automobile**

Showroom :

No. 1987, Trichy Main Road, LCT Complex,
Coimbatore - 641 005
Tel. : 0422 - 4041111

Workshop :

505/1, Sowaripalayam Main Road,
Ramanathapuram, Coimbatore - 641 045
Tel. : 0422 - 4051111

ERODE

* **Pressana Automobile**

Showroom & Workshop :

No.1, ChinnaKadu Thottam,
Veerapampalayam, Dhindal P.O., Erode - 638 012
Tel. : 0424 - 2276046 / 47
Fax : 0424 - 2276048

HOSUR

* **Thriive Cars**

Showroom & Workshop :

S. No. - 321, Bathala Palli,
SIPCOT- II, Hosur - 635109.
Tel. : 04344 - 644588 / 9994099116

KARUR

* **Pressana Automobile**

Showroom & Workshop :

No.3, Salem Bypass Road, Kulathupalayam,
Karur - 635 006
Tel. : 04324 - 222301
Fax : 04324 - 222302

MADURAI

* **A.R.A.S. Motors (P) Ltd.**

Showroom :

35/1, Dindigul National Highway,
Near A. R. C. Parcel Service, Villangudi,
Madurai - 625 018
Tel. : 0452 - 2669617, 3091917
Fax : 0452 - 2669618

Workshop :

Plot No. 64 & 68, Thiruvallavanallur Post,
National Highway No. 7, Opp Arokya Milk
Processing Unit, Nagari, Madurai - 625 221
Tel. : 0452 - 2463612 / 13 / 14

NAGERCOIL

* **A.R.A.S. Motors (P) Ltd.**

Showroom & Workshop :

2/86, Tirunelveli Main road,
Ozhuginasery, Nagercoil - 629 001
Tel. : 04652 - 644664 (Showroom)
04652 - 272443 (Workshop)

NAMAKAL

* **Thriive Cars**

Workshop :

276/85, Tiruchengode Main Road,
Opp. Old Lakshmi Kalyana Mandapam,
Namakkak - 637 001

PUDUKOTTAI

* **Jayaraj Karz**

Showroom & Workshop :

5915/1, Khalif Nagar, Thirumayam Road,
Pudukottai - 622 001
Tel. : 04322 - 262223

PERAMBALUR

* **Jayaraj Karz**

Showroom & Workshop :

No. 36, Trichy to Chennai Highway, Eraiyur,
Veppanhattai, Perambalur, Tamilnadu - 621 133
Tel. : 9244222728

SALEM

* **Thriive Cars**

Showroom & Workshop :

1116, Salem Chennai Highway Road,
Near Holy Cross, Hr. Sec. School,
Ammamet, Salem - 636 014
Tel. : 0427 - 2242603
Fax : 0427 - 2242604

TRICHY

* **Jayaraj Karz**

Showroom & Workshop :

Madurai Main Road, Panjapur, Trichy - 620 012
Tel. : 0431 - 2906420 / 6541207
Fax : 0431 - 2202187

THIRUNELVELLI

* **A.R.A.S. Motors (P) Ltd.**

Showroom & Workshop :

1183/3, National Highway Jothipuram,
Konganthanparai, Thirunelveli - 627 007
Tel. : 0462 - 2551070, 3269638
Fax : 0462 - 2554111

TIRUPUR

* **Anamallais Agencies Pvt. Ltd.**

Showroom & Workshop :

396/6, Kamaraj Road, Palladam Road,
Tirupur - 641 604
Tel. : 0421 - 2918999

* **THANJAVUR**

Jayaraj Karz

Showroom & Workshop :

Pudukottai Bye - Pass Road, Thanjavur
Tel. : 04362 - 226452

VELLORE

* **Sayar Cars**

Showroom & Workshop :

S.F. No. 3004, New By Pass Road,
Near Collectorate, Vellore - 632 004
Tel. : 0416 - 2222017

STATE - TELANGANA

HYDERABAD

* **Kun Automobiles (P) Ltd.**

Showroom & Workshop 1 :

Plot No. 74, Snehapuri Colony, Near Andhra Bank,
Nagole Main Road, Nagole, Hyderabad - 500 035
Tel. : 040 - 24220013, 44886666, 44886767/700/701
Fax : 040 - 24220313

Showroom 2 :

House No. 1-3-1045, Viceroy Hotel Lane,
Kawadiguda Road, Hyderabad - 500 080
Tel. : 040 - 2752385 - 89
Fax : 040 - 27532384

Workshop 2 :

1-8-670, Azamabad, RTC 'X' Road,
Hyderabad-500020
Tel. : 040 - 27668678 / 27668761
Fax : 040 - 27668632

206 Service Network

Workshop 3 :

Plot No. 21, Mini Industrial Estate,
Hafeezpet Road, Kondapur, Hyderabad - 500 049
Tel. : 040 - 31906677

Workshop 4 :

Plot No.37, Survey No.45,Vignan Junior College
Road, Kundapur, Hyderabad - 500 081
Tel. : 040 - 31906699

* **Orange Auto Pvt. Ltd.**

Showroom 1 :

6-3-249/3, Abhinandan Towers, Road No. 1,
Banjara Hills, Hyderabad - 500 034
Tel. : 040 - 66515555
Fax : 040 - 66469999

Workshop 1 :

B-45/46, Industrial Estate, Near Andhra Bank
Sanatnagar, Hyderabad - 500 018
Tel. : 040 - 66265555 / 66269999

Showroom & Workshop 2 :

16-2-705/1/1, Malakpet, Opp. Srukrupa Market,
Hyderabad - 500 036
Tel. : 040 - 66815555
Fax : 040 - 66179999

Showroom & Workshop 3 :

A2, Balanagar Techno Craft Industrial Estate,
Balanagar, Hyderabad - 500 037
Tel. : 040 - 23721111
Fax : 040 - 23729999

KARIMNAGAR

* **Kun Automobiles (P) Ltd.**

Showroom & Workshop :

M.No.8-6-128, Kothi Rampur, Hyderabad Highway
Road, Karim Nagar - 505 001
Tel. : 0878 - 2276633 / 9885520022
Fax : 0878 - 2276633

KHAMMAM

* **Fusion Motors**

Showroom & Workshop :

Plot No. 11, Sri Sri Circle, Opp. Reliance Petrol Bunk,
Rotary Nagar, Bypass Road, Khammam - 507 002
Tel.: 9247623666, 8096991122

WARANGAL

* **Kun Automobiles (P) Ltd.**

Showroom :

Door No. 15-2-4-1-1 & 15-2-4,
Mulugu Cross, Warangal - 506 007
Tel. : 0870 - 2421955
Fax : 0870 - 2421955

Workshop :

H. No. 23-6-132, Hunter Road,
Opp. Citizens Club, Warangal
Tel. : 0870 - 2523377 / 88 / 99
Fax : 0870 - 2523399

EAST ZONE

STATE - ARUNACHHAL PRADESH

ITANAGAR

- * **Sango Motors**
Showroom & Workshop :
NH-52A, Near Shiv Mandir, 6 Km
Between Nahalagun, Dist. Papumpare
Itanagar, Arunachal Pradesh - 791 110
Tel. : 0360 - 2001166 / 67, 2033153

STATE - ASSAM

BONGAIGAON

- * **Raj N Dibyani Automobiles**
Showroom & Workshop :
Near Lower Assam Hospital, Chapaguri Road,
North Bongaigaon, Bongaigaon
Tel. : 03664 - 231890, 230545

DIBRUGARH

- * **Pashupati Traders**
Showroom & Workshop :
P. N. Road, Chiring Chapori, Dibrugarh - 786 001
Tel. : 0373 - 2323281
Telefax : 0373 - 2323296

GUWAHATI

- * **Srishti Automobiles Pvt. Ltd.**
Showroom :
Opp. Pantaloons, G S Road, Rukminigaon,
Guwahati, Assam - 781 022
Tel. : 0361 - 2223666
Fax : 0361 - 2223888

Workshop :

Radha Nagar, VIP Road, Six mile, Guwahati,
Assam - 781 022

JORHAT

- * **Nova Automobiles**
Showroom & Workshop :
Pulibor, NH 37, PO: RRL, Jorhat - 785006
Tel. : 0376 - 2370077

Workshop 2 :

Nova Furniture Factory Compound,
Milan Nagar, Jorhat - 785001
Tel. : 0376 - 2309263

SHIBSAGAR

- * **Pashupati Traders**
Showroom & Workshop :
KPM Chariali, Shivasagar, Shivasagar - 785 604
Tel. : 03772 - 220082 / 88

SILCHAR

- * **Smart Motors Pvt. Ltd.**
Showroom & Workshop :
NH-54, Ramnagar, Silchar - 788 008
Tel. : 03842 - 268701, 9207042806

NAGAON

- * **LB Motor (A Unit of Borah & Sons Pvt. Ltd)**
Showroom & Workshop :
AT Road, Dimarguri, Nagaon - 782 003
Tel.: 03672 - 253157

TEZPUR

- * **GNB Motors**
Showroom :
P.O. Nikamul, Beside Udyanpath,
Tezpur - 784 001
Tel. : 03712 - 255999

Workshop :

P.O. Nikamul, Udyanpath,
Tezpur - 784 001
Tel. : 03712 - 255998

TINSUKIA

- * **Dhansri Motors**
Showroom & Workshop :
Opposite New Tinsukia Railway Junction,
A.T. Road, Hijuguri, Tinsukia - 786 125.
Tel. : 0374 - 2311397

STATE - BIHAR

BHAGALPUR

- * **Hare Krishna Motors Pvt. Ltd.**
Workshop :
Raman Bihar Colony, Rani Talab, Poll Factory,
Sabour Road, Bhagalpur - 813210
Tel. : 7070899679

MUZAFARPUR

- * **Pandey Motors Pvt. Ltd.**
Showroom & Workshop :
Mithila Body Builders, NH-18,
Bhagwanpur, Muzafarpur - 842 001
Tel. : 0621 - 2252762

PATNA

- * **Pandey Motors Pvt. Ltd.**
Showroom :
Pandey Plaza, Exhibition Road, Patna - 800 001
Tel. : 0612 - 2205195, 3955491
Fax : 0612 - 2205196

Workshop :

Bhoothnath Road, Sahadurpur, PS Agamkuan,
Patna - 800 020
Tel. : 0612 - 2341151

GAYA

- * **Brijnandan Automobile Pvt. Ltd.**
Showroom & Workshop :
727 Old 1026 / New No. NH - 83,
Near BMP - 3, Gaya - 823 004
Tel. : 0631 - 2200131

PURNEA

- * **Hare Krishna Motors Pvt. Ltd.**
Showroom & Workshop :
Damka Chowk, NH - 31, Gulababagh, Purnea - 854 326
Tel. : 9234323211

STATE - JHARKHAND

BOKARO

- * **Power Motors**
Showroom & Workshop :
N-1, City Centre, Sector - 4,
Bokaro Steel City, Bokaro - 827 004
Tel. : 06542 - 233555 / 232977
Fax : 06542 - 232988

DHANBAD

- * **Sorabh Automobiles**
Showroom :
Indramani Palace, Opp Flair Bajaj, Saraidhela,
Dhanbad - 826 001
Tel. : 0326 - 2201366

208 Service Network

Workshop :

Tilakraidih, Govindpur Road, Dhanbad - 826 001
Tel. : 9470580855

HAZARIBAGH

- * **Laxmi Auto Showroom & Workshop :**
Zulu Park Road, Near SBI Main Branch,
Hazaribagh - 825 301
Tel. : 06546 - 222929

JAMSHEDPUR

- * **Narbheram Motors Pvt. Ltd. Workshop :**
M-4, Phase-VI, Adityapur Industrial Area,
P.O. Gamaria, Jamshedpur - 832 108
Tel. : 0657 - 3293612, 3297763, 3290649, 6510531
Telefax : 0657 - 2200532

RANCHI

- * **Rahul Automobiles Pvt. Ltd. Showroom 1 :**
Piska More, Ratu Road, Ranchi - 834 005
Tel. : 0651 - 2510251 / 52

Showroom 2 :

Line Tank Road, MR Tower, Ranchi - 834 001
Tel. : 0651 - 3298436
Fax : 0651 - 2510252

Workshop :

Kokar Industrial Area,
Near Hindustan Newspaper Office, Ranchi - 834 001
Tel. : 0651 - 6555594

STATE - ORISSA

BALASORE

- * **Venus Auto Works Pvt. Ltd. Showroom & Workshop :**
NH - 5, Remuna Golai, Januganj,
Near Bhattar Mill, Balasore -756 019
Tel. : 06782 - 244013, 244014

BHUBANESWAR

- * **Venus Auto Works Pvt. Ltd. Showroom & Workshop :**
A/62, Nayapalli, Bhubaneswar - 751 003
Tel. : 0674 - 3019999 (Showroom)
0674 - 3019900, 3270444, 9337070444
(Workshop)
Telefax : 0674 - 3019908

- * **Super Sales Automobiles Pvt. Ltd. Showroom & Workshop :**

Plot No. 644/2148, NH-5, Pahal,
Bhubneswar, Dist - khurda - 752 101
Tel. : 0674 - 2463913, 2463914, 6543010 / 11

SAMBALPUR

- * **Bharat Motors Ltd. Showroom & Workshop :**
9, Industrial Estate, Near Central School,
Bareipali, Sambalpur - 768 006
Tel. : 0663 - 2402736, 2405286
Fax : 0663 - 2585894

ROURKELA

- * **Balaram Motors Showroom & Workshop :**
Opposite Pahadi Kanta, Vedyvash, Rourkela - 769 041

STATE - WEST BENGAL

ASANSOL

- * **Shaila Autotech Showroom & Workshop :**
NH-2, Chanda More, Asansol - 713 339
Telefax : 0341 - 2343704 / 705

HOWRAH

- * **Priti Motor Udyog (P) Ltd. Showroom :**
NH-6, Bomabay Howrah Highway, Howrah

Workshop :

Khejurtala Kolkata Truck Terminal,
Khejurtala, NH-6, Howrah - 711 403
Tel. : 033 - 65002070/71/72

KOLKATA

- * **Speed Autotech Showroom :**
"The Meridian", Kazi Nazrul Islam Sarani,
(VIP Road), Kolkata - 700 059
Tel. : 033 - 25007915 - 9
Fax : 033 - 40150824

Workshop 1 :

241/2B, APC Road, Opp. Khanna Cinema,
Kolkata - 700 004
Tel. : 033 - 25551370 / 72 / 73 / 74, 25552509

Workshop 2 :

108 F, Nilgunge Road, Agarpara, Kolkata - 700 058
Tel. : 033 - 25552509

- * **Dulichand Motors Pvt. Ltd. Showroom :**

"Shrachi Towers", 686 Anandapur,
E.M. Bypass, Near Ruby Hospital, Kolkata - 700 107
Tel. : 033 - 24431801 - 02, 40141616
Fax : 033 - 40141624

Workshop :

5/51, Jagatipota, Ahalya Nagar,
Opp. Jagatipota Kisan Market, Kolkata - 700 099
Tel. : 033 - 40161718, 24264224, 24264214

- **Longia Motors Pvt. Ltd. Showroom 1 :**

15/1D, Sahanagar Road, (Near Rashbehari Avenue
Crossing), Kolkata - 700 026
Tel. : 033 - 66270100 / 119
Fax : 033 - 66270121

Workshop 2 :

Budge Budge Trunk Road, Rampur,
P.O. : Gobindapur, P.S. : Maheshstala,
Kolkata - 700 141
Tel. : 033 - 66270222 / 223 / 205
Fax : 033 - 66270208

SILIGURI

- * **Kaysons Automotive Pvt. Ltd. Workshop :**

IIIRD Mile, Checkpost, Opp. New Eastern Bypass
Road, Sevoke Road, Siliguri - 734 401
Tel. : 0353 - 2544533 - 35, 2777723
Fax : 0353 - 2544456

STATE - MANIPUR

- IMPHAL**
★ **Rajpri Enterprise**
Showroom & Workshop :
Chigmeirong Mamang Leikai,
Imphal East, Imphal - 795 001
Tel. : 0385 - 2421183

STATE - NAGALAND

- DIMAPUR**
★ **Urban Station**
Showroom & Workshop :
NSC Petrol Pump, NH-39, 6th Mile, Kohima Road,
Dimapur, Nagaland - 797 112
Tel. : 03862 - 240994, 240992

STATE - TRIPURA

- AGARTALA**
★ **Sri Krishna Automobiles**
Showroom & Workshop :
Plot No. 4612 & 4615, Shanihani,
Airport Road, Agartala, Tripura West - 799 001
Tel. : 0381 - 2342566

STATE - MEGHALAYA

- SHILLONG**
★ **DH Royal Cars**
Showroom & Workshop :
Parkview, Fire Brigade,
Shillong - 793 014
Tel. : 0364 - 2520481, 2520477

STATE - SIKKIM

- GANGTOK**
★ **GEN X Motors**
Workshop :
C/o Garima Enterprise, P.S. Road, Gangtok - 737 101
Tel. : 03592 - 202515

STATE - MIZORAM

- AIZAWL**
★ **Highland**
Showroom & Workshop :
A-L Road, Zemabawk, Aizawl - 796 017
Tel. : 0389 - 2351916

210 Service Network

INTERNATIONAL

SRI LANKA

- ★ **Mag City Motor Company Pvt. Ltd.**
Showroom & Workshop :
No. 320A, Darley Road,
Colombo - 10, Sri Lanka
Tel. : 0094777410407

BHUTAN

- ★ **Global Trade**
Showroom :
Lkahilham, Changankha,
Thimphu, Bhutan

- Workshop :**
Post Box No. 1037, Olarongcchu,
Thimphu, Bhutann



Help us serve you better!

Any feedback / complaints / grievance send us or contact at:
General Motors India Private Limited
A-16, MIDC Talegaon Industrial Area (Phase-II), Near Floriculture Park,
Talegaon Navlakh Umbre Village Road, Tehsil-Maval,
Pune – 410507, Maharashtra, India.
Tel. +91 2114 663939
For Customer Assistance Centre call at +91 124 3080000 or email at gmi.cac@gm.com
24 Hr. Helpline at 1800 3000 8080
24 x 7 Roadside Assistance at 1800 103 8090 (Toll Free No.) or +91 124 4388090

Disclaimer-

All information, illustrations and specifications contained in this Owner's Manual are based on the latest production information available at the time of publication. The right is reserved to make changes at any time without notice.

Part No.: 28287959
Revision No. 00
Revision Date
07/2015/1,020