

**FIND NEW ROADS™**

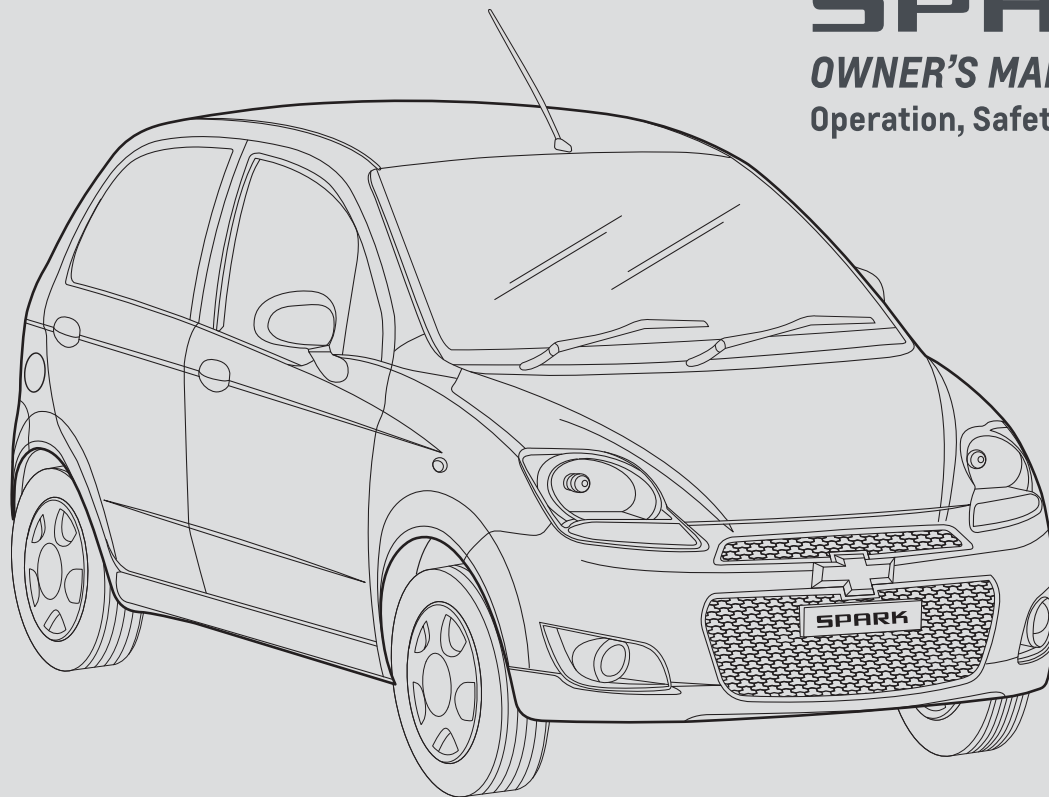

# **SPARK**

**OWNER'S MANUAL**

**Operation, Safety and Maintenance**

Dear Customer,

Welcome to the Chevrolet family. We wish to thank you for choosing Chevrolet Spark.

It is our constant endeavor to provide you with products that offer excellent performance through out their ownership period. Which is why, in addition to producing great cars, we have also set up an extensive, and very well equipped network of retailers and authorized service centres across the country.

Naturally, these Chevrolet retailers knows everything there is to know about your car, and provides you with the best service possible. In fact, every retailer is equipped with the most advanced technology, technicians specially trained by us, and genuine spares. Needless to say, they are also committed to ensure your complete satisfaction.

So, please contact a Chevrolet retailer for any servicing need and make sure that only genuine spares are used for your car.

This Manual will familiarize you with the operation and maintenance of your new vehicle. It will also provide you with important safety information. Please do read it carefully and follow the recommendations. In fact, the Manual is like a permanent part of your car. And it would go a long way in ensuring a safe and trouble-free operation for your car.

Should you have any query please feel free to call our 24 hr. Helpline at 1800 3000 8080 or email us at : [gmi.cac@gm.com](mailto:gmi.cac@gm.com).

Happy Motoring

## IMPORTANT NOTICE

Please read this Manual and follow the instructions carefully.

 : This is the safety alert symbol used to alert you to potential hazards including injuries or damage to your vehicle or other property. Obey all safety messages that follow this symbol.

Throughout this Manual you will find special notations:

- Warning
- Note
- Caution

### WARNING

**WARNING indicates a potentially hazardous situation which, if not avoided, could result in serious injury or death.**

### NOTE

**NOTE indicates information which will assist you with maintenance or other instructions concerning your vehicle.**

### CAUTION

**CAUTION indicates a potentially hazardous situation which, if not avoided, may result in minor or moderate injuries, or damage to your vehicle or other property.**

 : This is a safety symbol which means 'Do not', or 'Do not do this', or 'Do not let this happen'.

\* **or (Option)** : The asterisk and (Option) in this Manual signify an item of equipment that is not included on all vehicles. Such items include engine options, model variations specific to one country, and optional equipment.

All information, illustrations, and specifications in this Manual are based on the latest product information available at the time of publication.

General Motors India Pvt. Ltd. (GMI) reserves the right to change specifications or designs at any time without notice and without incurring obligation.

This vehicle may not comply with the standards or regulations of other countries. Before attempting to register this vehicle in any other country, check all applicable regulations and make any necessary modifications.

This Manual describes the options and trims available at the time of publication. Some of the items covered may not apply to your vehicle. Contact your CHEVROLET retailer for information on option and trim availability.

Non-GMI genuine parts and accessories have not been examined or approved by GMI. We can certify neither the suitability nor the safety of non-GMI genuine parts and accessories and are not liable for damage caused by their use.

**Important:** Read Section 2 ("Seats and Occupant Protection Systems") of this Manual fully and carefully before operating your vehicle.

**Warning :** Tampering of wiring harness or fitment of non genuine accessories in your vehicle may lead to short circuit resulting in fire.

We wish you many hours of pleasurable driving **Chevrolet**.

# TABLE OF CONTENTS

<b>1. CSIPL WARRANTY &amp; SERVICE BOOKLET</b> .....	<b>1-1</b>
(Information about Product Warranty, Rust Warranty & Emmision Warranty Policy)	
<b>2. SEATS AND OCCUPANT PROTECTION SYSTEMS</b> .....	<b>2-1</b>
(Important information about safety belts and other safety features)	
<b>3. INSTRUMENTS AND CONTROLS</b> .....	<b>3-1</b>
(Information about instruments, gauges and vehicle controls)	
<b>4. HEATING &amp; AIR CONDITIONING</b> .....	<b>4-1</b>
(How to operate your heating, ventilation and air conditioning system)	
<b>5. DRIVING YOUR VEHICLE</b> .....	<b>5-1</b>
(Information about how to drive your vehicle under various conditions)	
<b>6. EMERGENCIES</b> .....	<b>6-1</b>
(Important information about what to do if you have a problem while driving)	
<b>7. SERVICE AND VEHICLE CARE.</b> .....	<b>7-1</b>
(Information about how to properly maintain your vehicle)	
<b>8. MAINTENANCE SCHEDULE</b> .....	<b>8-1</b>
(Information about when to perform vehicle maintenance and the items to be checked)	
<b>9. TECHNICAL INFORMATION</b> .....	<b>9-1</b>
(Vehicle specifications, lubricant types and other useful information)	
<b>10. 24x7 ROADSIDE ASSISTANCE</b> .....	<b>10-1</b>
<b>11. SERVICE NETWORK</b> .....	<b>11-1</b>



# 1 CSIPL WARRANTY & SERVICE BOOKLET

- 
- STANDARD LIMITED WARRANTY COVERAGE ..... 1-2
  - PREDELIVERY INSPECTION & VEHICLE DELIVERY ... 1-8
  - OWNER'S STATEMENT OF ACCEPTANCE ..... 1-9
  - CHEVROLET SERVICE ..... 1-11
  - MAINTENANCE RECORD SHEET ..... 1-17
  - BATTERY ..... 1-19
  - SEPARATE CORROSION PROTECTION SERVICE ..... 1-20
  - BODY INSPECTION RECORD ..... 1-21
  - EMISSION WARRANTY ..... 1-23
  - ANNEXURE - I ..... 1-26
  - ANNEXURE - II ..... 1-27

## STANDARD LIMITED WARRANTY COVERAGE

### 1. SCOPE

General Motors India Private Limited, a private limited company incorporated under the companies Act 1956 bearing CIN U34100GJ1994PTC021818 and having its Registered office at Shreenathji Compound, Survey No. 1871, Naz Road, Village Jetalpur, Taluka Daskroi, Ahmedabad, Gujarat – 382 426 and Works at A-16, MIDC Talegaon Industrial Area (Phase-II), Near Floriculture Park, Talegaon Navlakh Umbhre Village Road, Tehsil-Maval, Pune -410507, Maharashtra (“General Motors India”) warrants that your new Chevrolet Spark (“vehicle”) is free from defect in material or workmanship, subject to your compliance with the following terms and conditions mentioned hereunder and other vehicle maintenance norms as mentioned elsewhere in this service booklet.

Only an authorized CHEVROLET retailer as mentioned in this booklet will make the necessary repairs, using new, re-conditioned or re-manufactured parts with a view to correcting any defect covered by this warranty.

### 2. WHAT IS COVERED

Time and distance limits for New Vehicle Warranty coverage.

Warranty Type	Warranty Limits	Other Warranties
<b>A : General</b>	Three (3) years or 1,00,000 kms (whichever is earlier) from the date of delivery by a CHEVROLET retailer or the date of first registration of the motor vehicle, whichever occurs first.	These parts are covered by other warranties : 1. Battery (one (1) year) (covered by the battery manufacturer**) 2. Tires (one (1) year) (covered by the tire manufacturer**) 3. Audio/Radio/Acc. (one (1) year) (covered by the Audio/Radio/Acc. manufacturer**) See clause 5.
<b>B : Rust Through*</b>	Three (3) years from the date of delivery of the motor vehicle or from the date of first registration of the motor vehicle, whichever occurs first.	The warranty covers exterior body metal except : 1. Items not covered by warranty listed in Section 3 2. Exhaust pipe and fuel system rust

\* A hole through a body panel caused by rust / corrosion from inside to outside.

\*\* Service / warranty shall be provided by the concerned equipment manufacturer.

- The obligation under this New Vehicle Warranty is limited to the repair of the new motor vehicle at no charge by the CHEVROLET authorized retailer. For parts replaced during such repair the same warranty applies until the end of the New Vehicle Warranty period as stipulated herein. All warranty claims expire at the end of the warranty period as specified under Clause 2. The Owner is responsible for any repair or replacement which are not covered by this warranty.
  - Liability of **General Motors India Pvt. Ltd.** under this New Vehicle Warranty is limited to the value of the service, repairs/ replacement of parts found to be defective within the warranty period. Beyond servicing and/or repairing defective parts in the vehicle, **General Motors India Pvt. Ltd.** does not undertake to replace the vehicle / or reimburse the purchaser by payment of any money in respect of the vehicle purchased by them.
  - Under the terms of New Vehicle Warranty, installation, free service will be provided only within the municipal limits of the cities/towns where **General Motors India Pvt. Ltd.** has its service network, *as elaborated elsewhere in this Service booklet.* This list of authorized retailers is subject to change/modification without prior notice. Service outside the municipal limits specified above will be provided after charging the actual to and fro traveling and incidental expenses, as prevailing from time to time.
  - Necessary care and caution is taken in manufacturing of the vehicle, however, **General Motors India Pvt. Ltd.** shall not be liable for any loss or damage caused to any article, property, death or disability caused to any human life arising out of fire, electric fault, short circuit, accidental handling or negligent use of the vehicle. The maximum liability in monetary terms shall be restricted to the value of the defective parts and / or value of services rendered only. Furthermore, the New Vehicle Warranty, in no case, shall extend to the payment of any monetary consideration whatsoever, of the replacement or return of the vehicle as a whole.
  - The decision of **General Motors India Pvt. Ltd.** will be final and binding on all matters arising out of this New Vehicle Warranty.
  - The owner should preserve the original Invoice for necessary verification and produce the same, as and when required.
  - The optimum performance of the vehicle is under standard test conditions.
- This New Vehicle Warranty is issued at Talegaon, District Pune, Maharashtra and competent courts shall have exclusive jurisdiction over matters by or following from time to time.



### 3. WARRANTY LIMITATIONS

The warranty will cease to exist in following conditions:

- a. Failure to have the required periodic inspection and required service performed as per the Periodic Maintenance Schedule.
- b. Improper or wrong maintenance and in deviation with guidelines mentioned in this service booklet.
- c. Any modification, alterations made to the vehicle such as including but not restricted to adding lights, changing engine specifications to increase horsepower, or using wide tires, and or any other modification in the vehicle that may likely to have an effect on the performance of the vehicle. (e.g.: a defect caused by the installation of non homologated wheels and tires are not covered by the warranty.)
- d. Failure to use genuine parts, /fluids (oil, coolant, brake fluid) and / or other accessories / consumables recommended or approved by General Motors India Pvt. Ltd.
- e. Use of the vehicle for purposes or in a manner other than the one mentioned in the Owner's Manual. Exceeding specified capacities such as loading weight, passenger, speed, use as a commercial vehicle and rpm limitations.
- f. Damage caused by driving the vehicle under severe conditions such as un-pliable or water-logged roads, in races or rallies.
- g. Damage caused by natural disasters including but not restricted to earthquakes, storms, floods, fire and accidents.

The owners are recommended to keep their vehicle insurance valid at all times.

- h. Damage caused by smoke, chemicals, bird-droppings, salt, stone chipping, scratches, iron dust or any other extraneous circumstances like external mechanical or chemical influences (regarding paint or body damage, specially stone throw, air-borne rust, industrial fall out), damage to catalytic converter due to use of wrong/bad quality fuel acting on the vehicle.
- i. Damage caused by normal wear (for instance brake-pad, etc.) or exposure to the elements such as discoloring or deformation of any interior, plastic, chrome or painted part or surface.
- j. Sensory complaint by the owner against symptoms such as noise, vibration or oil stains which do not effect performance.
- k. Damage which should have been detected during normal usage but became serious when left unattended to and/or the owner of the vehicle having failed to claim and having rectified a defect which was already apparent during vehicle delivery, immediately after delivery or a defect which becomes apparent at a later date immediately after it became apparent.
- l. Failure of the owner to adhere to the requirements outlined in Clause 4.
- m. Fuel system damage caused by water or other foreign matter in the fuel system.

- n. Damage caused by the installation of non genuine accessories or equipment after the vehicle has been purchased from the CHEVROLET authorized retailer such as radio, car telephone, CD radio set, or cargo carrier and / or other activities of a similar nature.
- o. Consumptive parts and oil/grease and other fluids. (See the following tables of consumptive parts and oil/grease and other fluids.)
- p. Adjustments, cleaning, inspection, or required periodic maintenance.
- q. Parts designated as requiring periodic replacement.
- r. Warranty repair not performed by a CHEVROLET authorized retailer.
- s. Charges or fees for telephone, tow, transportation charges of the vehicle to the nearest CHEVROLET authorized retailer, rental car, and so forth; compensation for inconvenience or commercial losses; all other consequential costs relating to the owner being unable to use the vehicle.
- t. Any accident, damage, loss or destruction due to negligent, careless use of vehicle.
- u. Damage to the engine while driving in water logged conditions or entry of water in to the engine.
- v. Repair of the vehicle during warranty period by an unauthorized service center.
- w. Retrofitment of CNG/LPG Kit.

**WHAT IS NOT COVERED**

<b>Consumptive Parts</b>	<b>Oil/Grease and other fluids:</b>
Spark plug	Engine oil
Drive belts	Transmission oil
Air cleaner element	Power steering fluid*
Fuel filter	Brake fluid
Oil filter	Coolant
Clutch disc, clutch parts	Grease
Brush holders	Washer fluid
Brake shoe and pads	Battery fluid
Brake discs	Gasoline
Brake drums	Air conditioner refrigerant
Wiper blades	Other lubricants, etc.
Light bulbs	
Motor brushes	
Fuses, etc.	

No warranty repair shall be made if it is found that the Vehicle Identification Number like chassis / engine number, odometer or the warranty & service booklet, have been tampered with. This list is neither exclusive nor exhaustive and the decision of General Motors India Pvt. Ltd. shall be final and binding.

#### **4. WHAT THE OWNER MUST DO**

In order to keep this warranty valid you must:

- a. Use your vehicle as instructed in the Owner's Manual.
- b. Have your vehicle inspected according to this schedule.  
The cost of the service is borne by the owner. If the services are not performed within the specified time limits, the general and the rust through warranty as referred to under Clause 2 above, shall be rendered null and void and shall not be reinstated by a subsequent service.
- c. Keep the warranty & service booklet (Owner's Manual) and all receipts in a safe place to present to the CHEVROLET retailer at regular maintenance visits and when repair work is required.

#### **5. PARTS COVERED BY OTHER WARRANTY CONDITION**

- a. Battery : The coverage period is 1 year from the date of new vehicle registration regardless of the distance traveled.
- b. Tires : This warranty is covered by the tire manufacturer. The coverage period is one year. Please check with your CHEVROLET retailer for details.
- c. Audio/Radio/Acc. : This warranty is covered by the audio/radio/Acc. manufacturer. The coverage period is one year. Please check with your CHEVROLET retailer for details.

#### **6. MAKING THE WARRANTY EFFECTIVE**

The warranty goes into effect after CHEVROLET authorized retailer fills in the appropriate information about your vehicle and places the retailer's official seal and signature in the warranty & service booklet (Owner's Manual).

#### **7. REQUIREMENTS FOR WARRANTY WORK**

To have warranty work carried out, present the warranty & service booklet to the authorized CHEVROLET retailer as mentioned in this booklet. If the warranty & service booklet is lost or incomplete, work to be carried out with respect to the standard warranty shall be refused.

#### **8. CHANGE OF OWNERSHIP**

If the vehicle is sold during the warranty period, please deliver the warranty & service booklet to the new owner.

The new owner will need to complete the change of address or subsequent ownership notification card located elsewhere in this booklet in order for the coverage to be transferred.

#### **9. EXPENSES ASSOCIATED WITH WARRANTY WORK**

The expenses of repair work and parts of your Chevrolet will be covered by Chevrolet standard limited warranty in accordance with the WARRANTY & SERVICE BOOKLET (OWNER'S MANUAL). Other expenses that are not covered by the Chevrolet Standard Limited Warranty must be covered by the owner.

**10.** General Motors India Private Limited is launching the Chevrolet Spark in different cities in a phased manner. The CHEVROLET retailer responsible for delivering your Spark is qualified to provide all Spark related services within the city where he is located. As other CHEVROLET retailers become operational to handle the Spark, they will also be able to provide similar Spark related services. **IN ORDER FOR THE WARRANTY ON YOUR VEHICLE TO APPLY, IT IS IMPERATIVE THAT YOUR SPARK BE SERVICED, HANDLED AND ATTENDED TO ONLY BY CHEVROLET RETAILER AS SET FORTH IN THIS BOOKLET.**

**11.** The following requisite document should be presented to the CHEVROLET retailer at the time of making a claim under New Vehicle Warranty:

- Original invoice issued by CHEVROLET retailer.
- Warranty and service booklet / maintenance record.
- Any other document deemed to be necessary by CHEVROLET retailer and/or General Motors India Pvt. Ltd.

## **PREDELIVERY INSPECTION AND VEHICLE DELIVERY**

Before delivering the vehicle we carried out a thorough predelivery inspection in order to ensure that your Chevrolet vehicle is in a fault-free condition. Accompanying this appropriately filled out service booklet (Owner's Manual) are the tool kit and your vehicle documents.

You have been informed of the service intervals and necessary service checks, including under extreme operating conditions and in particular with regard to oil changing of petrol engines.

\_\_\_\_\_  
City, date :

\_\_\_\_\_  
CHEVROLET Retailer's / ASO's Stamp and Signature

## OWNER'S STATEMENT OF ACCEPTANCE

I hereby certify that the car has been delivered in an orderly and proper operating condition, including **Keys, Service Booklet (Owner's Manual) and Tool Kit. I have read and understood the terms and conditions pertaining to the New Vehicle Warranty and agree to abide by the same.**

I have been informed of the service intervals and necessary service checks, including under extreme operating conditions.

\_\_\_\_\_  
Date of delivery :

\_\_\_\_\_  
City, date :

\_\_\_\_\_  
Name and signature of customer :

This sheet must be detached prior to vehicle delivery and placed with the vehicle file **after it has been signed** by the customer.





**CHEVROLET**

Dear Customer,

We are confident that you and your family would be enjoying the safe and comfortable drive of the Chevrolet Spark.

We would like to undertake a thorough check-up of the vehicle at 1000 kms or 30 days, whichever occurs earlier. This will also allow us to re-emphasize the salient features of the Spark to you.

**In the unlikely event of an emergency assistance, please call your nearest CHEVROLET retailer as mentioned in this booklet or please feel free to call our 24 hr. helpline at 1800 3000 8080.**

**1st Free Inspection - 1 Month / 1000 km  
(whichever occurs earlier)**

VIN no. \_\_\_\_\_

PDI no. \_\_\_\_\_

Date of service \_\_\_\_\_

Date of delivery \_\_\_\_\_

Retailer code \_\_\_\_\_

Customer's name \_\_\_\_\_

Customer's tel. no. \_\_\_\_\_

I confirm that the vehicle has been inspected and delivered to my satisfaction.

Retailer's Signature    Customer's Signature



**1st Free Inspection - 1 Month / 1000 km (whichever occurs earlier)**

**ENGINE CONTROL SYSTEM**

Drive Belt <small>(Alternator, Power Steering and A/C Compressor)</small>	<input type="checkbox"/>	Engine Oil and Engine Oil Filter	<input type="checkbox"/>
Cooling System and Hose Connections	<input type="checkbox"/>	Engine Coolant	<input type="checkbox"/>
Fuel Filter	<input type="checkbox"/>	Air Cleaner Element	<input type="checkbox"/>
Spark Plugs	<input type="checkbox"/>	Ignition Cable	<input type="checkbox"/>
Valve Clearance	<input type="checkbox"/>	Charcoal Canister and Vapor Lines	<input type="checkbox"/>
PCV System	<input type="checkbox"/>	Timing Belt	<input type="checkbox"/>

**CHASSIS AND BODY**

Exhaust Pipe & Mountings	<input type="checkbox"/>	Brake /Clutch Fluid	<input type="checkbox"/>
Front Brake Discs & Pads	<input type="checkbox"/>	Rear Brake Drums and Linings	<input type="checkbox"/>
Parking Brake	<input type="checkbox"/>	Brake Line & Connections (Including Booster)	<input type="checkbox"/>
Rear Hub Bearing and Clearance	<input type="checkbox"/>	Manual Transaxle Fluid : Leak Check	<input type="checkbox"/>
Clutch and Brake Pedal Free Play	<input type="checkbox"/>	Tire Condition and Inflation Pressure	<input type="checkbox"/>
Wheel Alignment <small>(As and when required or as suggested by CHEVROLET retailer.)</small>	<input type="checkbox"/>	Wheel Balancing <small>(As and when required or as suggested by CHEVROLET retailer.)</small>	<input type="checkbox"/>
Steering Wheel and Linkage	<input type="checkbox"/>	Power Steering Fluid and Lines	<input type="checkbox"/>
Drive Shaft Boots	<input type="checkbox"/>	Safety Belts, Buckles and Anchorages	<input type="checkbox"/>
Lubricate Locks, Hinges & Hood Latch	<input type="checkbox"/>		<input type="checkbox"/>
Chassis and Underbody Bolts and Nuts Tight/Secure	<input type="checkbox"/>		

**Note** - Cost of materials and consumables to be borne by customer.  
For detailed information refer section 'Maintenance Schedule'.

**2nd Free Inspection - 6 Months / 5000 km (whichever occurs earlier)**

**ENGINE CONTROL SYSTEM**

- |                                                               |                          |                                   |                          |
|---------------------------------------------------------------|--------------------------|-----------------------------------|--------------------------|
| Drive Belt<br>(Alternator, Power Steering and A/C Compressor) | <input type="checkbox"/> | Engine Oil and Engine Oil Filter  | <input type="checkbox"/> |
| Cooling System and Hose Connections                           | <input type="checkbox"/> | Engine Coolant                    | <input type="checkbox"/> |
| Fuel Filter                                                   | <input type="checkbox"/> | Air Cleaner Element               | <input type="checkbox"/> |
| Spark Plugs                                                   | <input type="checkbox"/> | Ignition Cable                    | <input type="checkbox"/> |
| Valve Clearance                                               | <input type="checkbox"/> | Charcoal Canister and Vapor Lines | <input type="checkbox"/> |
| PCV System                                                    | <input type="checkbox"/> | Timing Belt                       | <input type="checkbox"/> |

**CHASSIS AND BODY**

- |                                                                                     |                          |                                                                                     |                          |
|-------------------------------------------------------------------------------------|--------------------------|-------------------------------------------------------------------------------------|--------------------------|
| Exhaust Pipe & Mountings                                                            | <input type="checkbox"/> | Brake /Clutch Fluid                                                                 | <input type="checkbox"/> |
| Front Brake Discs & Pads                                                            | <input type="checkbox"/> | Rear Brake Drums and Linings                                                        | <input type="checkbox"/> |
| Parking Brake                                                                       | <input type="checkbox"/> | Brake Line & Connections (Including Booster)                                        | <input type="checkbox"/> |
| Rear Hub Bearing and Clearance                                                      | <input type="checkbox"/> | Manual Transaxle Fluid : Leak Check                                                 | <input type="checkbox"/> |
| Clutch and Brake Pedal Free Play                                                    | <input type="checkbox"/> | Tire Condition and Inflation Pressure                                               | <input type="checkbox"/> |
| Wheel Alignment<br>(As and when required or as suggested by<br>CHEVROLET retailer.) | <input type="checkbox"/> | Wheel Balancing<br>(As and when required or as suggested by<br>CHEVROLET retailer.) | <input type="checkbox"/> |
| Steering Wheel and Linkage                                                          | <input type="checkbox"/> | Power Steering Fluid and Lines                                                      | <input type="checkbox"/> |
| Drive Shaft Boots                                                                   | <input type="checkbox"/> | Safety Belts, Buckles and Anchorages                                                | <input type="checkbox"/> |
| Lubricate Locks, Hinges & Hood Latch                                                | <input type="checkbox"/> |                                                                                     | <input type="checkbox"/> |
| Chassis and Underbody Bolts and Nuts Tight/Secure                                   | <input type="checkbox"/> |                                                                                     |                          |

**Note** - Cost of materials and consumables to be borne by customer.  
For detailed information refer section 'Maintenance Schedule'.

**CHEVROLET Inspection**

**2nd Free Inspection - 6 Months / 5000 km (whichever occurs earlier)**

VIN \_\_\_\_\_

Regn. No. \_\_\_\_\_

Delivery date \_\_\_\_\_

Date of service \_\_\_\_\_

Kms \_\_\_\_\_

I confirm that the job has been attended to my satisfaction.

Customer's Signature

Labour free & Parts are chargeable  
(Retain with job card)

\_\_\_\_\_  
Delivering Retailer's stamp & date

I hereby certify that the work has been carried out as per the schedule.

\_\_\_\_\_  
Servicing Retailer's / ASO stamp & date

**3rd Free Inspection - 1 Year / 10000 km (whichever occurs earlier)**

**ENGINE CONTROL SYSTEM**

- |                                                               |                          |                                               |                          |
|---------------------------------------------------------------|--------------------------|-----------------------------------------------|--------------------------|
| Drive Belt<br>(Alternator, Power Steering and A/C Compressor) | <input type="checkbox"/> | Engine Oil and Engine Oil Filter<br>(Replace) | <input type="checkbox"/> |
| Cooling System and Hose Connections                           | <input type="checkbox"/> | Engine Coolant                                | <input type="checkbox"/> |
| Fuel Filter                                                   | <input type="checkbox"/> | Air Cleaner Element                           | <input type="checkbox"/> |
| Spark Plugs                                                   | <input type="checkbox"/> | Ignition Cable                                | <input type="checkbox"/> |
| Valve Clearance                                               | <input type="checkbox"/> | Charcoal Canister and Vapor Lines             | <input type="checkbox"/> |
| PCV System                                                    | <input type="checkbox"/> | Timing Belt                                   | <input type="checkbox"/> |

**CHASSIS AND BODY**

- |                                                                                     |                          |                                                                                     |                          |
|-------------------------------------------------------------------------------------|--------------------------|-------------------------------------------------------------------------------------|--------------------------|
| Exhaust Pipe & Mountings                                                            | <input type="checkbox"/> | Brake /Clutch Fluid                                                                 | <input type="checkbox"/> |
| Front Brake Discs & Pads                                                            | <input type="checkbox"/> | Rear Brake Drums and Linings                                                        | <input type="checkbox"/> |
| Parking Brake                                                                       | <input type="checkbox"/> | Brake Line & Connections (Including Booster)                                        | <input type="checkbox"/> |
| Rear Hub Bearing and Clearance                                                      | <input type="checkbox"/> | Manual Transaxle Fluid : Leak Check                                                 | <input type="checkbox"/> |
| Clutch and Brake Pedal Free Play                                                    | <input type="checkbox"/> | Tire Condition and Inflation Pressure                                               | <input type="checkbox"/> |
| Wheel Alignment<br>(As and when required or as suggested by<br>CHEVROLET retailer.) | <input type="checkbox"/> | Wheel Balancing<br>(As and when required or as suggested by<br>CHEVROLET retailer.) | <input type="checkbox"/> |
| Steering Wheel and Linkage                                                          | <input type="checkbox"/> | Power Steering Fluid and Lines                                                      | <input type="checkbox"/> |
| Drive Shaft Boots                                                                   | <input type="checkbox"/> | Safety Belts, Buckles and Anchorages                                                | <input type="checkbox"/> |
| Lubricate Locks, Hinges & Hood Latch                                                | <input type="checkbox"/> |                                                                                     | <input type="checkbox"/> |
| Chassis and Underbody Bolts and Nuts Tight/Secure                                   | <input type="checkbox"/> |                                                                                     |                          |

**Note** - Cost of materials and consumables to be borne by customer.  
For detailed information refer section 'Maintenance Schedule'.

**CHEVROLET Inspection**

**3rd Free Inspection - 1 Year / 10000 km (whichever occurs earlier)**

VIN \_\_\_\_\_

Regn. No. \_\_\_\_\_

Delivery date \_\_\_\_\_

Date of service \_\_\_\_\_

Kms \_\_\_\_\_

I confirm that the job has been attended to my satisfaction.

Customer's Signature

Labour free & Parts are chargeable  
(Retain with job card)

\_\_\_\_\_  
Delivering Retailer's stamp & date

I hereby certify that the work has been carried out as per the schedule.

\_\_\_\_\_  
Servicing Retailer's / ASO stamp & date





## BATTERY

Battery type : \_\_\_\_\_

Battery make : \_\_\_\_\_

Battery number : \_\_\_\_\_

### IMPORTANT INSTRUCTIONS

- The battery must be fitted firmly in the cradle.
- Connecting cables and connectors must be fastened securely on to the battery.
- Connections must be made in the right polarity.
- Terminals must be kept coated with petroleum jelly/vaseline. **DO NOT USE GREASE.**
- Battery top & vent plugs must always be kept clean & dry.
- Electrolyte level must always be maintained in line with the bottom of the vent hole. In case of any drop in electrolyte level, add pure distilled water. **NEVER ADD ACID.**
- Battery is warranted for a period of one year only.
- Liability under this warranty is limited to defects arising out of faulty material or workmanship developing under proper use and **NOT** when the battery is merely discharged.

- Defects arising out of faulty vehicle electrical systems, negligent maintenance, incorrect charging or improper filling of the battery by unauthorized dealer/auto electricians are not covered by warranty.
- Consequent liabilities are not covered by this warranty policy.
- Get Battery checked every 3 months.

CHEVROLET Retailer's  
Stamp



## **SEPARATE CORROSION PROTECTION SERVICE**

### **Body/ Underbody Corrosion Protection Service**

General Motors India Pvt. Ltd. provides a three (3) years warranty that no rust-through of the body/underbody will occur, provided that the directives from General Motors India Pvt. Ltd. concerning the treatment, maintenance, and care of the vehicle (Owner's Manual) and especially the inspection and checks prescribed in the service booklet have been carried out.

Furthermore, the body paintwork and the corrosion protection must be visually inspected for damage as part of the regular annual inspection or 10,000 kms service. The customer is informed of any damage detected and measures to rectify this damage. Any damage discovered is also indicated in the following corrosion protection diagram.

Confirmation of the inspection is indicated by a stamp and dated signature, accompanied by indication of the vehicle mileage on the following verification documents.

Make use of this possibility in order to avoid problems during warranty claims regarding rust-through of the body / underbody.

The rust through warranty is not applicable if areas damaged by any reason remain unattended and become the cause of corrosion.

All repairs when required should be carried out promptly and by the CHEVROLET retailer.

## BODY INSPECTION RECORD

Vehicle identification number : \_\_\_\_\_

Registration number : \_\_\_\_\_

Name / address of owner : \_\_\_\_\_

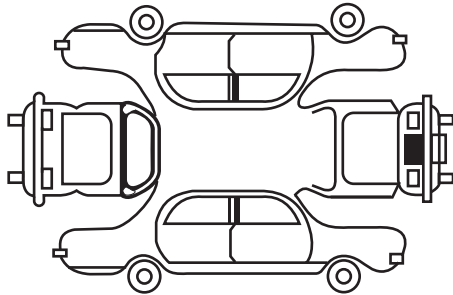

**Use the following symbols to indicate damage.**

- Chipping                      × Dent / Bumpy
- ▲ Scratch                        ■ Other damage
- ↑ Antirust re-treatment necessary

In order to maintain the Chevrolet rust-through warranty, the vehicle must be subjected to an inspection by CHEVROLET retailer once a year. Any resulting work is subject to a charge.

Check-up 1st year after initial registration.

Check-up date : \_\_\_\_\_

Odometer reading : \_\_\_\_\_

- Damage found :
- 1. Outer body                      Yes     No
  - 2. Under body                      Yes     No
  - 3. Engine compartment    Yes     No

Retailer stamp / signature : \_\_\_\_\_

Damage repaired :                      Yes                       No

Remarks : \_\_\_\_\_

\_\_\_\_\_

\_\_\_\_\_

## BODY INSPECTION RECORD

Vehicle identification number : \_\_\_\_\_

Registration number : \_\_\_\_\_

Name / address of owner : \_\_\_\_\_  
 \_\_\_\_\_

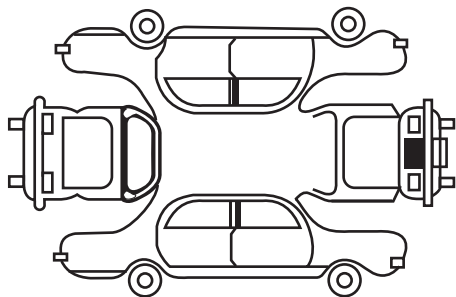

**Use the following symbols to indicate damage.**

- Chipping
- ▲ Scratch
- ↑ Antirust re-treatment necessary
- × Dent / Bumpy
- Other damage

In order to maintain the Chevrolet rust-through warranty, the vehicle must be subjected to an inspection by CHEVROLET retailer once a year. Any resulting work is subject to a charge.

Check-up 2nd year after initial registration.

Check-up date : \_\_\_\_\_

Odometer reading : \_\_\_\_\_

- Damage found :
- 1. Outer body            Yes     No
  - 2. Under body            Yes     No
  - 3. Engine compartment    Yes     No

Retailer stamp / signature : \_\_\_\_\_

Damage repaired :            Yes             No

Remarks : \_\_\_\_\_  
 \_\_\_\_\_  
 \_\_\_\_\_

## EMISSION WARRANTY

### (Applicable in NCR Delhi, Chennai, Kolkata and Mumbai)

Subject to other terms of the warranty policy and the conditions and obligations laid down hereunder, General Motors India Pvt. Ltd., certifies that the components liable to affect the emission of the gaseous pollutants in the vehicle in the normal use despite the use to which it may be subjected, comply with the provisions of Rule 115 (2) of the Central Motor Vehicle Rules, 1989, and further warrants that if on examination by a service center duly authorized by the General Motors India Pvt. Ltd., the vehicle is discovered to be failing to meet the emission standard as specified in the said rule, our authorized service center shall take such corrective measures as may be necessary and shall at its sole discretion either repair or replace free of charge such components of emission control system as are specified in Annexure II hereof.

The definitions of various terms used in Emission warranty proposal are given in

Annexure –I. These definitions shall be in line with the definition of the existing product Warranty definition.

#### Conditions :

1. This warranty will be in addition to and will run concurrently and parallel to the product warranty and will apply only in respect to components as mentioned in Annexure-II.
2. The period of the vehicle's warranty shall commence from the date of the vehicle sale.
- 2.1 Warranty period - **1,00,000 kms or 3 years** whichever occurs earlier, from date of the vehicle sale.
3. The warranty claim will be accepted only after examination carried out by CHEVROLET Retailers leading to a firm conclusion that none of the original settings /specifications have been tampered with and that the components (s) as mentioned in Annexure –II has / have a manufacturing defect, and / or, that the vehicle is unable to meet the In-use emission standard.
4. The methods of examination to determine the warrantable condition of the components will be at sole discretion of General Motors India Pvt. Ltd. and or its authorized service centers and results of such examination will be final and binding. If, on examination, the warrantable condition is not established, General Motors India Pvt. Ltd. will have the right to charge full, or part, of the cost of such examination and resulting repairs / rectification.
5. In case of acceptance of the warranty under Emission Warranty, General Motors India Pvt. Ltd. will replace, at CHEVROLET Retailers, free of charge, the components which are covered as mentioned in Annexure-II, but the consumables as mentioned in OM shall be charged as per actual applicable rates.
6. In case of a vehicle in which the components covered under Emission Warranty or the associated parts, are not independently replaceable, on

account of their being integral parts of a complete assembly, will have the sole discretion to replace either the entire assembly or by using some of the parts of the system through suitable repairs or modifications.

7. Any consequential repairs or replacement of parts which may be found necessary to establish compliance to In-use emission standards, in addition to the replacement of the components covered under Emission Warranty, will not be made free of cost unless such parts are also found to be in a warrantable condition within the scope and limit of the product Warranty (Chevrolet Spark-3 years / 1,00,000 kms, whichever is earlier). The consumables and labour shall be charged per actual during such repairs or replacement of parts.
8. All the parts removed for replacement under warranty will be the property of General Motors India Pvt. Ltd.
9. General Motors India Pvt. Ltd. will

not be responsible for the cost of transportation of the vehicle to the nearest Authorized Service Center or any loss due to non-availability of the vehicle during the period of a warranty claim and examination by CHEVROLET retailers.

10. General Motors India Pvt. Ltd. will not be responsible for any fines, penalties that may be charged by Statutory or Regulatory authorities on account of failure of the vehicle to comply with the in-use emission standards on the vehicle not meeting any such given legal / regulatory requirement, during inspection by such authorities.
11. Emission Warranty will be applicable irrespective of the change of ownership of the vehicle provided all the conditions as laid down in this document are met from the date of original sale of the vehicle.

**This Emission Warranty will be applicable only if the customer :**

- (i) Observes all the important instruc-

tions and any other precautions listed in the OM for use of the vehicle.

- (ii) Under all circumstances uses lubricants and fuel as recommended by General Motors India Pvt. Ltd.
- (iii) Regularly obtains and carries out maintenance at CHEVROLET retailers as per the list in this booklet only, in accordance with General Motors India Pvt. Ltd. guidelines and enters the details in the Service Booklet.
- (iv) Immediately approaches the nearest CHEVROLET retailers as per the list in this booklet upon discovery of failure to comply with the In-use emission standard inspite of having maintained and used the vehicle in accordance with the instructions in the OM and having carried out such repairs and adjustments as may be required with a view to establish such compliance.
- (v) Produces the 'Pollution Under Control (PUC)' certificate valid for the period immediately preceding the test during which the failure is

discovered, the test having been carried out either for obtaining a new certificate, or pursuant upon being directed by an officer as referred to in sub – rule (2) of Rule 116 of the Central Motor Vehicles Rules.

- (vi) Produces the Service Booklet (Owner’s Manual) and all relevant bills for verification of details.
- (vii) Produces receipts covering maintenance of the vehicle as specified in the OM from the date of original purchase of the vehicle.
- (viii) Produces valid certificate of insurance & RTO registration.

**Conditions under which warranty is NOT applicable:**

1. Non production/availability of a valid ‘Pollution under Control’ certificates as described in customer obligation (V).
2. In case the vehicle is not serviced by CHEVROLET retailers as per the list in this booklet as per the service schedule described in the

maintenance chart given in the Owner’s Manual.

3. A vehicle, which has been subjected to abnormal use, abuses, neglect and improper maintenance or has met with an accident.
4. Use of such replacement parts, which are not specified and approved by General Motors India Pvt. Ltd.
5. If the vehicle or parts thereof, have been altered, tampered with or modified or replaced in an unauthorized manner.
6. A vehicle on which the odometer is not functioning or the odometer has been changed or the reading of which has been changed / tampered with so that the actual mileage cannot be readily determined.
7. A vehicle, which has been used, for competitions, races, rallies or for the purpose of establishing records.
8. Examination by CHEVROLET retailers as per the list in this booklet of the vehicle shows that any of the conditions stipulated in the OM

with regard to use and maintenance have been violated.

9. A vehicle, which has been run on adulterated fuel or lubricant or fuels lubricants other than those, specified by General Motors India Pvt. Ltd.

**Scope and Limits:**

1. This emission warranty is in addition to the product warranty for the vehicle as per the scope and limit described in the OM and all conditions described therein will apply, in addition to those exclusively stipulated in this warranty.
2. The emission warranty covers only compliance with the emission standard as specified in sub rule (2) of Rule 115 of CMVR. It does not cover any other performance of these parts or routine test and consequent maintenance or adjustments to establish compliance to the in-use emission standard as applicable to the state, in which the vehicle is registered and is in use.

## ANNEXURE - I

### Definitions:

1. **Vehicle** : The Motor Vehicle approved for sale within India under the provisions of Central Motor Vehicle Rules, 1989 or any subsequent amendment or substitution thereof.
2. **Owner's Manual (OM)** : A document given to the customer at the time of sale of the vehicle giving guidelines on use and maintenance of the vehicle including the terms and conditions of Warranty.
3. **Maintenance** : Maintenance as per the schedule provided in the Owner's Manual by General Motors India Pvt. Ltd. including inspection, verification check, adjustment and replacement, if necessary.
4. **Service Booklet** : The scheduled service record book in Owner's Manual, which is required to be filled by CHEVROLET retailer at the time of service.
5. **Abnormal Use** : The situations when the vehicle is put to use other than that intended by General Motors India Pvt. Ltd. such as racing, overloading or use of adulterated fuel or fuel not recommended by General Motors India Pvt. Ltd.
6. **Manufacturing Defect** : Means deficiency or deviation from normal production tolerance in design, material, or workmanship in a device or system which affects any parameter, performance, or component belonging to emission control system.
7. **Product Warranty** : The manufacturer warranty as provided by General Motors India Pvt. Ltd., which covers failure of various parts and systems as per the Owner's Manual 3 years / 1,00,000 kms (Whichever is earlier).
8. **Emission Warranty** : Warranty for emission performance of the vehicle as determined by sub-rule (2) of rule no 115 of the Central Motor Vehicles Rules, 1989.
9. **Authorized Service Centers** : Any service facilities authorized by General Motors India Pvt. Ltd. to perform warranty repairs. This shall include all of CHEVROLET retailers that are recognised for service of subject vehicles or any other service center duly authorized by General Motors India Pvt. Ltd.
10. **Warrantable Condition** : Warrantable condition means any condition of a vehicle, which triggers the responsibility of General Motors India Pvt. Ltd. to take corrective action within the framework of emission Warranty. This however shall not include any statutory or regulatory fines or penalties.
11. **Warranted Parts** : Those components, listed as per Annexure-II.

---

## ANNEXURE - II

### List of Components Covered under Emission Warranty

S. No.	Part name
1	Catalytic Converter***
2	Exhaust Manifold Gasket
3	Electronic Control Module
4	MTIA
5	Manifold Absolute Pressure Sensor
6	Air Temp. Sensor
7	Oxygen Sensor
8	Coolant Temperature Sensor
9	Injectors
10	Knock Sensor
11	Exhaust Gas Re-circulation Valve

\*\*\* Catalytic Converter is covered only for emission related failures as provided under the warranty statement. Replacements if any shall not be applicable for breakage and noise problems.

**Note :** All the above mentioned parts are covered only if the car fails to meet the prescribed Emission norms. Any other performance problems shall be treated as not relevant to the Emission warranty.





# 2 SEATS AND OCCUPANT PROTECTION SYSTEMS

---

- ALWAYS WEAR YOUR SAFETY BELTS ..... 2-2
- FRONT SEAT OCCUPANTS ..... 2-6
- REAR SEAT OCCUPANTS ..... 2-6
- THREE-POINT SAFETY BELTS ..... 2-6
- CENTER REAR LAP BELT ..... 2-8
- PREGNANT WOMEN AND SAFETY BELTS ..... 2-9
- HEAD RESTRAINTS ..... 2-9
- CHILD RESTRAINTS ..... 2-10
- SECURING CHILD RESTRAINTS ..... 2-11
- FRONT SEATS ..... 2-12
- REAR SEATS ..... 2-13

## ALWAYS WEAR YOUR SAFETY BELTS!

Occupant protection has been the focus of much private and public research and development for many years. The seat belts are incorporated into the vehicle solely for the protection of the occupants. The safety belts can protect you and your passengers only if they are used.

The safety belt information included here is intended for vehicle occupants of adult size and for older children who have outgrown booster seats.

Be sure that if children are too small to be well restrained by the safety belt system, that they are secured in an appropriate child restraint.

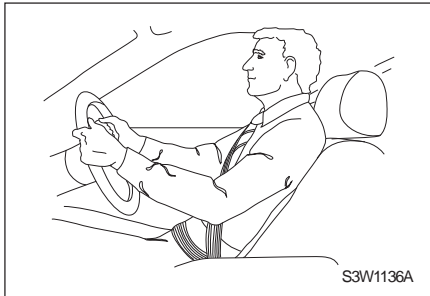

### WHY WEAR SAFETY BELTS?

Safety belts are helpful for several distinct reasons:

- 1) Safety belts attach the occupants to the vehicle so that they will not be ejected during an accident.
- 2) Safety belts attach the occupant to the vehicle so that they can use the space between their pre-crash seating position and the front of the vehicle to slow down to a stop more gradually, as their safety belts stretch and the front end of the vehicle absorbs the energy of the crash by crumpling.
- 3) Safety belts keep the driver in his seat, so that the driver might have a chance to regain control in certain accident situations.
- 4) Safety belts keep occupants from being catapulted into and injuring the driver and other occupants.

### ▲ WARNING

- **Safety belts have been shown to be the single most effective protection against injury or death in a vehicular accident!**
- **As the owner and driver of your vehicle, you must make certain that each occupant is properly wearing the safety belt provided at the seating position.**
- **Pregnant women, injured, and physically impaired persons should also wear safety belts. Like all other occupants, they are more likely to suffer serious injury or death, if they do not do so.**
- **The best way to protect the foetus is to protect the mother.**
- **Why safety belts work, how to wear them, and how to adjust your seat position properly, is explained in this section. Read all of the information provided and always observe these instructions and warnings in order to gain the full benefit of these safety systems.**

## HOW SAFETY BELTS WORK!

*Safety belts cannot work unless they are worn and worn properly.*

Vehicle occupants are injured if the forces applied to the body's structures are greater than the body can tolerate without being injured. If a person's body is stopped abruptly, the forces applied to the body will be high, whereas if the body is slowed down gradually over some distance, the forces will be much lower. Thus, in order to protect an occupant from injury in a crash, the idea is to give the person as much time and distance as possible in coming to a stop.

Imagine a person running at 15 miles per hour (25 km/h) head first into a concrete wall. Imagine a second person running at 15 miles per hour (25 km/h) into a wall covered by a 3-foot (90 cm) thick deformable cushion. In the first instance the person could be seriously injured or even killed. In the second, the runner could expect to walk away uninjured. Why? In the first instance, the body hit the non-yielding concrete surface and stopped immediately. All of the energy the sprinter built up was ab-

sorbed by the structures of the body, not by the non-yielding concrete surface. In the second example, the body had exactly the same amount of energy that had to be absorbed as in the first example, but it continued to move into the padding, giving the body additional time and distance to slow down to a complete stop as the padding absorbed the sprinter's energy by deforming.

If a car crashes into a concrete wall at 30 miles per hour (50 km/h), the front bumper of the car stops immediately, but the passenger compartment stops more gradually as the front structure of the vehicle crumples. The belted occupant is held to the seat and gains the advantage of the cushion provided by the crumpling of the front of the vehicle and the stretching of the safety belt webbing. That belted occupant's body slows down from 30 mph (50 km/h) to zero over a distance of 3-4 feet (90-120 cm). That belted occupant also remains properly positioned so that, if the air bag (if provided) deploys in a frontal collision, the occupant might never strike any rigid structures in the vehicle. The

unbelted occupant receives no such benefit. The unbelted person is not attached to the vehicle and so that person continues to travel at the vehicle's pre-crash speed of 30 miles per hour (50 km/h) until striking a hard object at approximately 30 miles per hour (50 km/h) and stopping abruptly. Even in a frontal collision in which the air bag (if provided) deploys, the unbelted front seat occupant remains at greater risk of serious injury or death than the properly restrained front seat occupant.

**▲ WARNING*****SAFETY BELTS PROTECT***

Accident statistics show that drivers and passengers properly wearing safety belts have a lower risk of being injured and a higher chance of surviving an accident. For this reason, wearing a safety belt is legally required in most countries.

***WEARING THE SAFETY BELT***

Each front seat and each outboard rear seat of your CHEVROLET vehicle is equipped with a three-point safety belt system that is anchored at three locations. All front and rear seat belts are stored and locked by a retractor mechanism. When set in its normal emergency locking mode, the three-point safety belt requires no length adjustment and allows freedom of movement when the vehicle moves at constant speeds.

(Continued)

**▲ WARNING**

However in a sudden or strong stop, or during heavy acceleration or deceleration, the safety belt will lock automatically to restrain the body.

In order to gain the full benefit of a safety belt, you must wear it correctly and position yourself correctly within your seat, as follows:

- Seatback upright (not reclined, to prevent you from “submarining” or slipping out from under the safety belt, and injuring vulnerable body parts in a crash.)
- Occupant sitting upright (not slouched, to properly position the lap and shoulder portions of the safety belt for maximum restraint and minimum injury to soft and vulnerable parts of your body in a crash)
- Safety belt latch plate and buckle securely fastened with a “click” (if the safety belt is not securely latched, it cannot provide any protection; pull on the belt to make sure it is secure)

(Continued)

**▲ WARNING**

- Lap portion of safety belt snug and low on hips and bony pelvis (not abdomen where the restraining belt could cause serious injury in a crash – **THIS IS PARTICULARLY IMPORTANT FOR PREGNANT WOMEN**)
- Shoulder portion of the safety belts over your outside shoulder and snug against the chest (not under an arm, around your neck, over an inside shoulder or behind your back, and not loose with slack allowing excessive forward movement and injury in a crash)
- Only one occupant per one safety belt (do not allow more than one person in a safety belt; multiple people in a single safety belt can exceed the capacity of the safety belts and people sharing a safety belt can cause crushing and other injuries to each other in a crash)

(Continued)

**▲ WARNING**

- Children in secure child seats (in a crash the forces are too great for an adult to hold onto a child and the adult will crush the child if they share the same safety belt)
- No unbelted occupants (occupants not wearing a safety belt are an injury threat to themselves and to other occupants in the vehicle because in a crash they become a free-flying body that will strike other persons in their path)
- No twisted safety belts (twisted safety belts will not move freely and restrain properly and can cut into the occupants rather than spread the force, thus increasing the risk of injury and death)
- Lock doors (unlocked doors increase the risk of injury and death from external impacts and ejection in a crash)

**▲ WARNING**

- Make periodic checks (while riding in the vehicle, check from time to time to be sure that the lap portion of the belt is snugly across the hips and has not ridden up around the waist and that the shoulder portion is midway over the shoulder and across the chest; properly positioned belts allow the stronger structures of the hips and shoulders to absorb the forces of the belt against the body, while improperly positioned belts may cause neck injury or injury to the vulnerable organs in the abdominal area).
- No hard or breakable objects, between safety belts and body parts (objects such as pens, glasses, etc. in the occupant's pocket or on the cloth can cause injury in the event of a collision)

(Continued)

**▲ WARNING**

- Improper use of a safety belt can cause serious injury. Do not modify the safety belt. Do not add any device which would affect the operation of the safety belt.
- Before you close the door, make sure the safety belt is out of the way. Otherwise, the belt and/or the vehicle body could be damaged.

**▲ WARNING**

If the safety belt goes over an armrest (if so equipped), lap portion of the safety belt could force the occupant's abdomen, not the bony pelvis, in a collision.

- Be sure that the safety belt goes under the armrests.

Failure to follow this can result in injuries or even death in case of a collision.

## FRONT SEAT OCCUPANTS

Each front seat is equipped with adjustable seat and seatback with height-adjustable head restraint and three point lap-and-shoulder safety belts.

## REAR SEAT OCCUPANTS

The rear seat is equipped with two outboard seating positions featuring three-point lap-and-shoulder safety belts and a center seat equipped with a lap safety belt.

## THREE-POINT SAFETY BELTS

To help reduce the risk of personal injury in collisions or sudden manoeuvres, your CHEVROLET vehicle is equipped with three-point safety belts. The two front seats and the two outboard rear seating positions are each equipped with three-point safety belts. These safety belts are each anchored in three locations to restrain passengers who are properly positioned and wearing the safety belt.

A three-point safety belt set in the ELR / WLR (Emergency Locking Retractor / Webbing Locking Retractor) mode requires no length adjustment and allows the freedom of body movement when the vehicle moves at a constant speed.

However, in the event of a sudden or strong stop, or during heavy acceleration or deceleration, the safety belt will lock automatically to restrain the body.

Always fasten your safety belts correctly:

1. Close and lock the doors.
2. Make sure seatback is upright.
3. Pick up the safety belt latch plate and use it to pull the belt across your body. Make sure the belt is not twisted. If the safety belt locks as you are pulling it out, allow it to rewind into the retractor. Pull the safety belt out again to a comfortable and secure length.
4. Position the shoulder belt midway over the shoulder and across the chest. Never place the shoulder belt across the neck. This assures that in the case

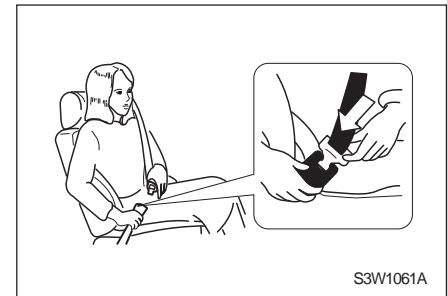
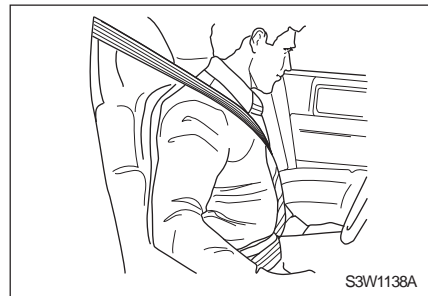

- of a collision, the belt applies force to the shoulder bones and keeps the impact away from ribs or neck, helping to avoid serious internal injuries.
5. Wear the lap belt low and snug on the hips, not the waist. This assures that in the case of a collision, the belt applies force to the pelvic bones and not the abdomen, helping to avoid serious injuries.
  6. Push the latch plate firmly into the buckle until the mechanism clicks. Make sure you are using the proper buckle. Be sure to position the release button on the buckle so you can unbuckle the safety belt quickly if necessary.
  7. Pull up on the latch plate to make sure it is secure.

To remove the safety belt, press the release button on the buckle. The belt will retract automatically. Guide the safety belt as it retracts to prevent the latch plate from damaging interior surfaces or injuring occupants.

### Maintain your safety belts:

1. Periodically inspect all safety belts, related parts, and assemblies. Have these replaced by your CHEVROLET retailer if any safety belts, assemblies or related parts are damaged.
2. You must replace any safety belt or related part that has been stretched or damaged in an accident, even if the stretching or damage is not obvious or visible. Stretched belts and damaged parts do not perform effectively. Replacement of safety belts must be with new belts only.
3. CHEVROLET recommends replacing the entire safety belt assembly after your vehicle has been in a collision. If your CHEVROLET retailer finds that no safety belt damage has occurred and that everything is in proper working order, you need not make any replacement.
4. It is dangerous to operate your vehicle with damaged safety belts or other parts.

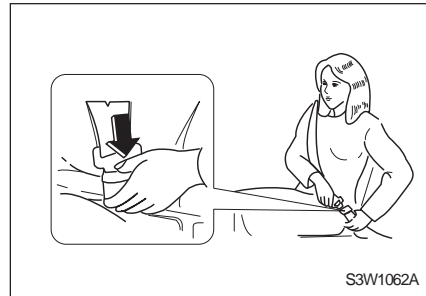
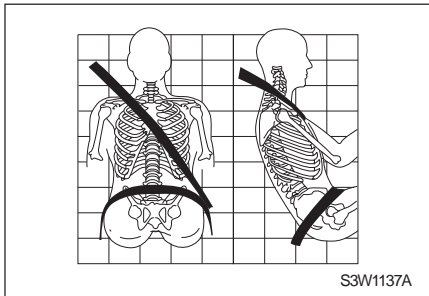



### CENTER REAR LAP BELT

To fasten the center rear lap belt:

1. Hold the metal latch plate 90-degrees to the belt and pull belt low across hips.
2. Insert the latch plate into the buckle.

3. Pull free end of belt away from latch plate to tighten belt.
4. Pull on belt clip to take up slack.

To remove the lap belt, press the release button on the buckle.

**▲ WARNING**

- After a collision, inspect all safety belts and related parts for fraying or other damage. Ask your CHEVROLET retailer to replace any damaged parts.
- It is dangerous to operate your vehicle with damaged safety belts or other parts.

Failure to make appropriate repairs may result in additional damage to your vehicle or personal injuries.

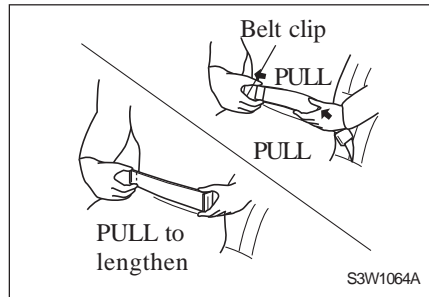
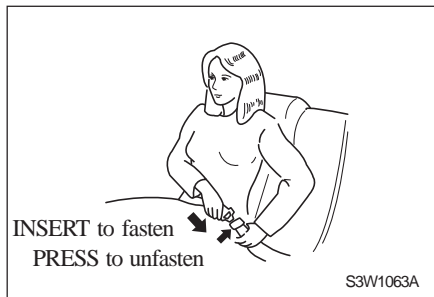

## PREGNANT WOMEN AND SAFETY BELTS

Safety belts work for everyone, including pregnant women.

Like all occupants, pregnant women are more likely to be seriously injured if they do not wear safety belts. In addition, when a safety belt is worn properly, it is more likely that the unborn child will be safe in a crash.

To provide maximum protection, a pregnant woman should wear a three-point safety belt. She should wear the lap portion of the belt as low as possible throughout her pregnancy.

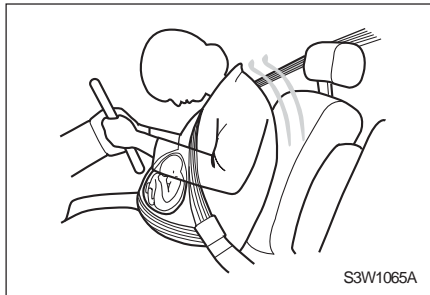

## HEAD RESTRAINTS

Head restraints are designed to reduce the risk of neck injuries in case of a collision.

For maximum protection, slide the head restraint up or down so the top of the restraint is level with the top of your ears.

### ▲ WARNING

**Removed or improperly adjusted head restraints can result in serious head and neck injuries in case of a collision.**

To adjust the front head restraints, raise the head restraint or push it down while pressing the release button.

If the head restraint must be removed for any reason,

1. Pull it up to the stop position.
2. While pushing the release button, lift the head restraint from the guide sleeve.

### ▲ WARNING

**Make sure that the head restraint has been put back into place and readjusted before driving.**

3. Replace head restraint and reset it in intended position before driving.

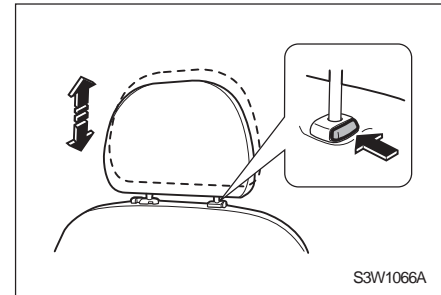

## CHILD RESTRAINTS\*

### CHILD RESTRAINT SYSTEMS

When a child restraint system is being used, pay attention to the following usage and installation instructions supplied with the child restraint system.

Always comply with local or national regulations. In some countries, the use of child restraint systems is forbidden on certain seats.



#### ▲ WARNING

**NEVER** use a rearward facing child restraint on a seat protected by an **ACTIVE AIRBAG** in front of it, **DEATH** or **SERIOUS INJURY** to the **CHILD** can occur.

### SELECTING THE RIGHT SYSTEM

Children should travel facing in the vehicle as long as possible. This makes sure that the child's backbone, which is still very weak, is under less strain in the event of an accident.

Children under 12 years or under 150 cm tall should only travel in an appropriate child safety seat.

Never carry a child whilst traveling in the vehicle. The child will become too heavy to hold in the event of a collision.

When transporting children, use the child restraint systems suitable for the child's weight.

Ensure that the child restraint system to be installed is compatible with the vehicle type.

#### ▲ WARNING

**If the vehicle is equipped with a lap belt on the rear center seat, no child restraint system is allowed on this seat.**

**It is advised to mount the child restraint system only on one of the rear outer seats.**

Ensure that the mounting location of the child restraint system within the vehicle is correct.

Allow children to enter and exit the vehicle only on the side facing away from the traffic.

When the child restraint system is not in use, secure the seat with a seat belt or remove it from the vehicle.

#### NOTE

**Do not stick anything on the child restraint systems and do not cover them with any other materials.**

**A child restraint system which has been subjected to stress in an accident must be replaced.**

**Please ensure that infants and children are seated in the rear seats using child restraints.**

**Until the children can use seat belts, please select a child restraint suitable for its age and make sure the child wears it. Please see the instructions on the relevant products for child restraints.**

## SECURING CHILD RESTRAINT USING SEAT BELT \*

This vehicle has the safety belt to secure the child restraint in rear outboard seating positions only. Be sure to follow the instructions that came with the child restraint. Secure the child in the child restraint when and as the instructions say.

1. Put the child restraint on the seat.
2. Pick up the latch plate, and run the lap and shoulder portions of the vehicle's safety belt through or around the restraint. The child restraint instructions will show you how.



3. Push the latch plate into the buckle until it clicks.

Position the release button on the buckle so that the safety belt could be quickly unbuckled if necessary.

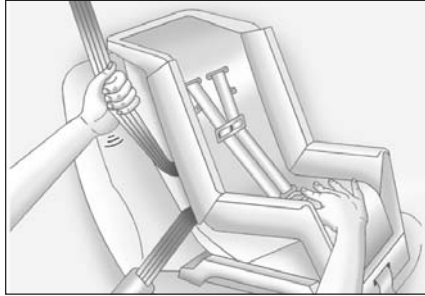

4. To tighten the belt, push down on the child restraint, pull the shoulder portion of the belt to tighten the lap portion of the belt and feed the shoulder belt back into the retractor. When installing a forward-facing child restraint, it may be helpful to use your knee to push down on the child restraint as you tighten the belt. If the child restraint system has a lock-off mechanism, use it to secure the vehicle safety belt.
5. If the child restraint has a top tether, follow the child restraint manufacturer's instructions regarding the use of the top tether.

6. Before placing a child in the child restraint, make sure it is securely held in place. To check, push and pull the child restraint in different directions to be sure it is secure.

To remove the child restraint, unbuckle the vehicle safety belt and let it return to the stowed position. If the top tether is attached to a top tether anchor, disconnect it.

### ▲ CAUTION

**Child safety restraints are available in a wide range of sizes and configurations. Due to the shape and dimensions of your vehicle's interior and seats, not all child safety restraints will fit in your vehicle.**

**It is your responsibility to ensure that the child safety restraint you install fits properly and can be adequately attached to the vehicle with the child safety restraint anchors. A child safety restraint that is not the correct size for the vehicle or the child, or a child safety restraint that is improperly attached to your vehicle can lead to serious personal injury to the child and other passengers in the vehicle in the event of a collision.**

## FRONT SEATS

### FRONT SEAT SLIDE ADJUSTMENT

To move the front seat forward or backward:

1. Pull up and hold the lever located under the front side of the front seat.
2. Slide the seat to the desired position.
3. Release the lever and make sure the seat is locked into place.

#### **▲ WARNING**

- Do not adjust the driver's seat while the vehicle is moving.

**Driver could lose control of the vehicle and injury or property damage could result.**

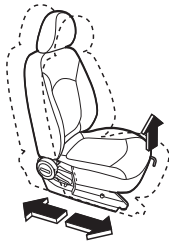

S3W1067A

### FRONT SEAT RECLINING ADJUSTMENT

To tilt seatback forward or backward, lift the lever up on the outside of the seat cushion until the seatback is adjusted to the desired position. Release the lever to lock the seatback in place.

#### **▲ WARNING**

- Do not adjust the driver's seatback while the vehicle is moving.

**Driver could lose control of the vehicle and injury or property damage could result.**

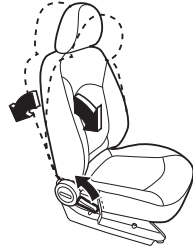

S3W1068A

#### **▲ WARNING**

**If a crash occurs, front occupants in reclined seats can lose restraining benefits of the seatback and safety belts by sliding out from under the safety belt or by being thrown into the seat belt in an awkward position.**

- Do not position either front seatback in the reclined position while the vehicle is being operated.

**Serious injuries, death and ejection from the vehicle can result.**

## REAR SEATS

### FOLDING REAR SEATBACK

The seatbacks can be folded down (Option) for additional cargo space.

1. To fold the seat cushion, pull the seat cushion up and fold it forward.

You may need to move the front seat forward or raise the front seatback to the upright position in order for the seat cushion to fold forward.

2. To fold down the seatback, lift the release knob on top of the seatback and fold the seatback forward.

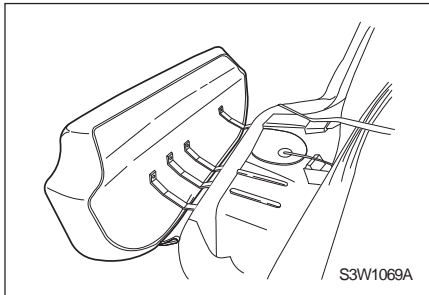

<b>▲ WARNING</b>
<b>Do not allow passengers to sit on the folded seatbacks while the vehicle is in motion.</b>
<b>Unrestrained luggage or passengers on a folded seatback can be thrown within or ejected from the vehicle in a sudden stop or accident.</b>

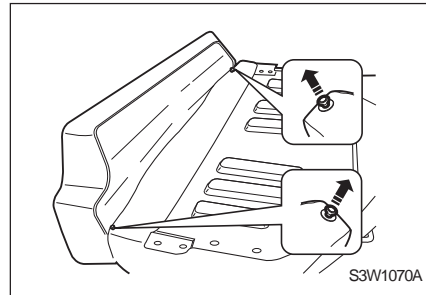

To return the seat to the passenger position, lift the seatback and push it rearward until it latches. Make sure the seat is locked in place.

To return the seat cushion to its original position, lift it up and push it back into place. Push the front part of the seat cushion down firmly until it latches.

Check to be sure that the safety belts are properly routed and are not twisted.

<b>▲ WARNING</b>
<b>Do not pull the release knobs on the top of the seatback while the vehicle is moving. This can cause damage or injuries to the occupants.</b>
<b>Make sure that the seatback and seat cushion, when returned to their original positions, are securely locked in place.</b>
<b>Make sure the rear seat safety belts and buckles are not pinched under the rear seat cushion.</b>

## 2-14 SEATS AND OCCUPANT PROTECTION SYSTEMS

---

# 3

## INSTRUMENTS AND CONTROLS

---

- QUICK VIEW - INSTRUMENTS AND CONTROLS .. 3-3
- INSTRUMENT CLUSTER ..... 3-4
- SPEEDO METER ..... 3-5
- DIGITAL TACHOMETER ..... 3-5
- ODOMETER ..... 3-5
- DISPLAY SELECTION THROUGH MODE  
& SET PUSH BUTTON ..... 3-6
- DIGITAL CLOCK (Option) ..... 3-7
- DIGITAL FUEL GAUGE ..... 3-8
- DIGITAL TEMPERATURE GAUGE ..... 3-8
- INDICATORS AND WARNING LAMPS ..... 3-8
- LIGHTS ..... 3-13
- WINDSHIELD WIPERS / WASHER LEVER ..... 3-17
- REAR WINDOW DEFROSTER (Option) ..... 3-18
- WINDOWS ..... 3-19
- KEYS ..... 3-20
- DOOR LOCKS ..... 3-21
- REAR CARGO AREA ..... 3-23

(Continued)



- 
- TAILGATE ..... 3-23
  - HOOD RELEASE ..... 3-24
  - DOME LAMP ..... 3-26
  - ASHTRAY (Option) ..... 3-26
  - CIGARETTE LIGHTER (Option) ..... 3-26
  - HORN ..... 3-27
  - STORAGE ..... 3-27
  - SUN VISORS (Option) ..... 3-28
  - ASSIST HANDLES ..... 3-29
  - LUGGAGE CARRIER (Option) ..... 3-29
  - ROOF RAIL (Option) ..... 3-30

## QUICK VIEW – INSTRUMENTS AND CONTROLS

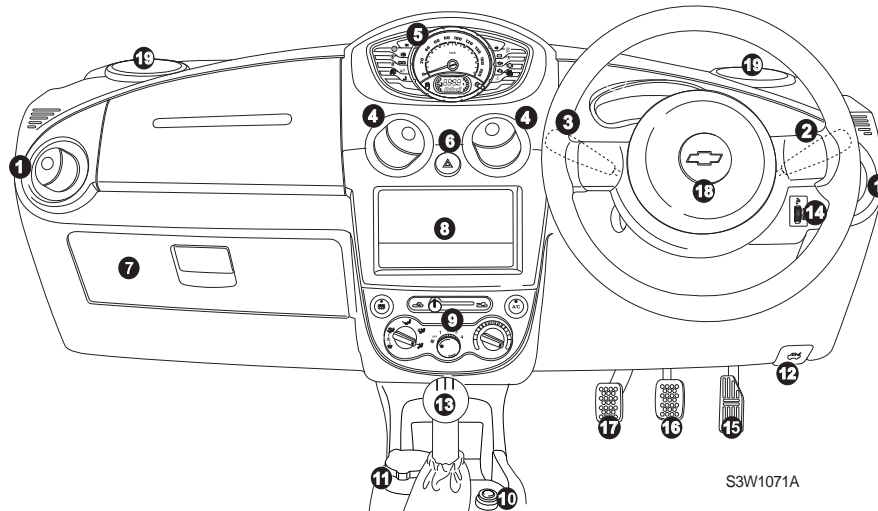

S3W1071A

- |                                                            |                                        |                              |
|------------------------------------------------------------|----------------------------------------|------------------------------|
| 1. Side Vent                                               | 7. Glove Box                           | 13. Gear Shift Lever         |
| 2. Wiper & Washer Control Lever                            | 8. Deposit Tray / Audio System*        | 14. Headlamp Leveling Switch |
| 3. Exterior Lights Control Lever                           | 9. Heating and Air Conditioning System | 15. Accelerator Pedal        |
| 4. Center Vents                                            | 10. Cigarette Lighter (Option)         | 16. Brake Pedal              |
| 5. Instrument Cluster, Indicator and Warning Lamps Display | 11. Ashtray (Option)                   | 17. Clutch Pedal             |
| 6. Hazard Warning Flasher Switch                           | 12. Hood Release                       | 18. Horn                     |
|                                                            |                                        | 19. Front Speaker Grill      |

## INSTRUMENT CLUSTER

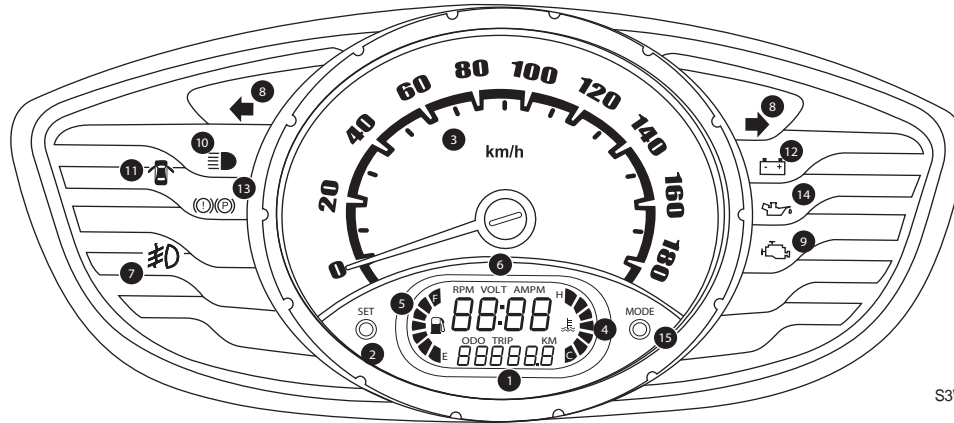

S3W1072A

- |                                     |                                         |                                                                       |
|-------------------------------------|-----------------------------------------|-----------------------------------------------------------------------|
| 1. Odometer / Tripmeter             | 7. Front Fog Lamp Indicator (Option)    | 13. Brake System Warning Lamp                                         |
| 2. Tripmeter / Clock Reset button   | 8. Turn Signal / Hazard Warning Flasher | 14. Engine Oil Pressure Warning Lamp                                  |
| 3. Speedometer                      | 9. Malfunction Indicator Lamp           | 15. Mode Change Button (Clock / Battery<br>Voltage / RPM / Tripmeter) |
| 4. Engine Coolant Temperature Gauge | 10. High Beam Indicator Lamp            |                                                                       |
| 5. Fuel Gauge                       | 11. Door Ajar Warning Lamp              |                                                                       |
| 6. Digital Clock                    | 12. Charging System Warning Lamp        |                                                                       |

## SPEEDOMETER

The speedometer displays the vehicle's speed.

The reading will be indicated in metric units of km/h (kilometers per hour).

## DIGITAL TACHOMETER

The tachometer indicates engine speed in revolutions per minute (RPM). Never operate the engine at higher rpm (above 4500 rpm).

### ⚠ CAUTION

**Excessive engine speed can damage the engine. This could result in costly repairs.**

## ODOMETER

The odometer displays the recorded distance.

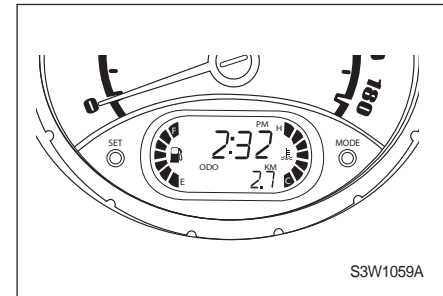
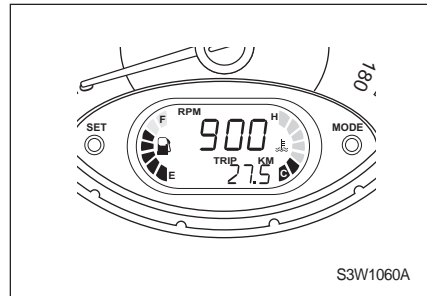
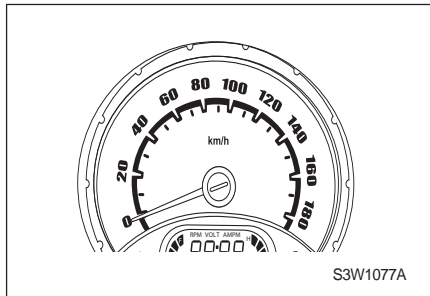

### DISPLAY SELECTION THROUGH MODE & SET PUSH BUTTON

Sl. No.	Current Display	Mode Push Button	Set Push Button
1	CLOCK, ODO	Display changes to Battery Voltage & ODO	Refer Clock mode setting
2	Battery Voltage, ODO	Display changes to RPM & TRIP	
3	RPM & TRIP	Display changes to Clock Mode & ODO	Refer TRIPMETER Setting

**Mode** button pressed once changes the current Clock & Odometer display to Battery Voltage and Odometer display.

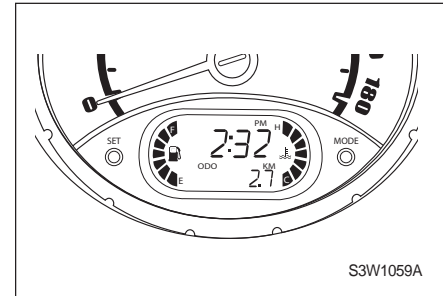

S3W1059A

Clock and Odometer Display

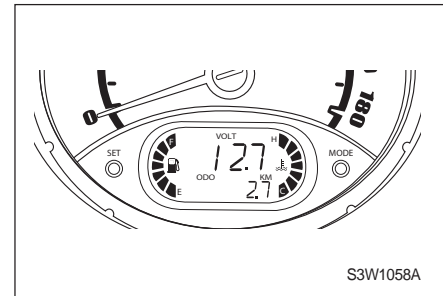

S3W1058A

Battery Voltage and Odometer Display

**Mode** button pressed once again changes the current Battery voltage and odometer display to RPM & Trip display.

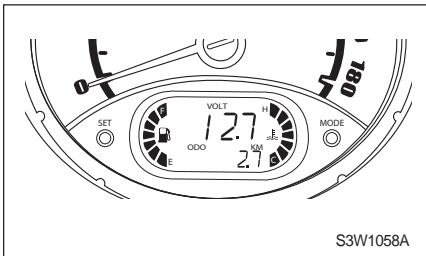

Battery Voltage and Odometer Display

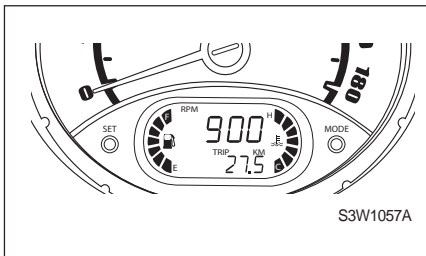

RPM and Trip Display

Again pressing **Mode** button will change to the initial Clock & Odometer display.

### TRIPMETER SETTING

By pressing **Mode** button, Tripmeter will be displayed.

Holding **Set** button for over 1 sec, the Trip meter can be reset to zero.

### DIGITAL CLOCK (Option)

When the ignition switch is turned to ON position, the digital clock displays the time.

Press **Set** button for 3 seconds. The clock will start flashing indicating that it has entered into “clock setting mode”. By pressing **Set** button within 1 second again, hours indication flashes. By pressing the **Set** button again minutes indication flashes.

Hours and minutes displayed can be adjusted by pressing the **Mode** button for 1 second or more.

While adjusting hours, the AM & PM automatically changes after every 12 hour display.

While the number is flashing, if no button is pressed for 5 seconds, current displayed value is stored & display stops flashing & it exits from clock setting mode.

Clock display start at 1:00 by default.

## DIGITAL FUEL GAUGE

Indicates how much fuel remains in the fuel tank when the ignition switch is turned ON.

- 1 Bar, E & Fuel symbol flashing with 1 Hz (Slow flash or 1 flash per second) - ----- **Fuel level 4.3L to 5.0L.**
- 1 Bar, E & Fuel symbol flashing with 2 Hz (Fast flash or 2 flash per second) - ----- **Fuel less than 3.2L** & will keep blinking with 2 Hz till empty tank.
- E & Fuel symbol flashing with 2Hz at empty tank.

After adding fuel and restarting the engine, the fuel gauge changes to show the new fuel level.

**Movement of the fuel within the fuel tank causes the fuel gauge to change when you brake, accelerate or turn.**

- Fuel tank capacity: 35 liters

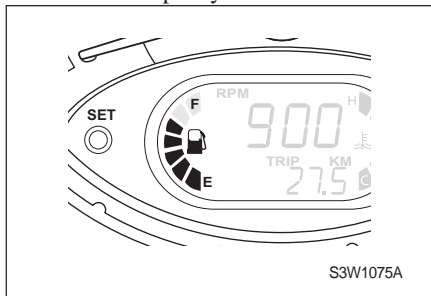

## DIGITAL TEMPERATURE GAUGE

Indicates engine coolant temperature when the ignition switch is turned ON.

**▲ CAUTION**

- **When temperature is high all the 7 bars on temperature gauge will be displayed and H & Temperature symbol will be flashing.**
- **Do not continue to drive your vehicle if the temperature gauge is in the hot zone. This means your engine is overheating.**

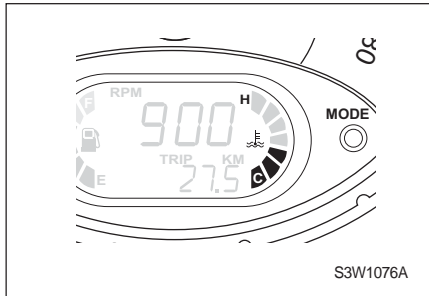

## INDICATORS AND WARNING LAMPS

Your vehicle is equipped with a number of warning lamps.

These warning lamps turn on when there may be or there is a problem with one of your vehicle's functions. Some warning lamps come on briefly when you turn the ignition key ON just to let you know they are working properly.

Location of the warning lamps and indicators is on the instrument panel.

## ENGINE OIL PRESSURE WARNING LIGHT

This lamp should come on when the ignition is ON but the engine is not running, as a check to show you it is working properly.

The lamp should go off after the engine starts.

If the engine oil pressure warning lamp comes on while driving, your engine oil pressure may be dangerously low. Stop the engine immediately and check the oil level.

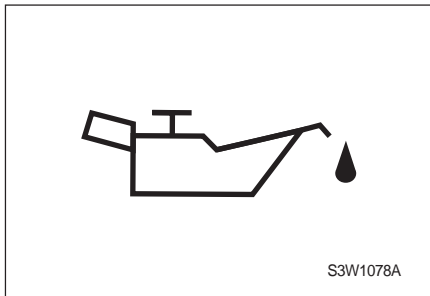

### ▲ CAUTION

- **Do not drive with the engine oil pressure warning lamp on.**

**Driving your vehicle with low oil pressure can result in costly damage to your vehicle.**

If the oil level is low, add the specified engine oil to the proper level.

If the oil level is normal, have your nearest CHEVROLET retailer check your vehicle's lubricating system.

## CHARGING SYSTEM WARNING LAMP

The lamp should come on when you turn the ignition ON. The lamp should go off when you start the engine.

### ▲ CAUTION

- **Do not drive your vehicle if the charging system warning lamp is always on.**

**Driving your vehicle while its charging system is malfunctioning can cause damage to the vehicle.**

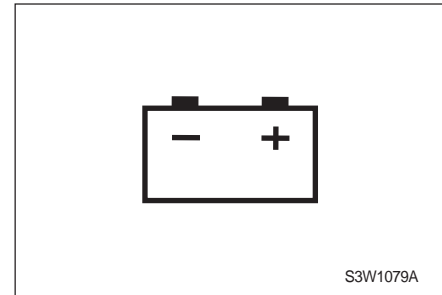



If the charging system warning lamp comes on while you are driving:

1. Pull safely off the road.
2. Stop your vehicle.
3. Make sure the drive belt is not loose or broken.
4. If the drive belt is in proper working order but the charging system warning lamp stays on, there may be a problem somewhere in the charging system.

Take your vehicle to your nearest CHEVROLET retailer for repairs as soon as possible.

### BRAKE SYSTEM WARNING LIGHT

This light should come on when the ignition is ON but the engine is not running, as a check to show you it is working properly.

The lamp should go off after the engine starts.

If the light comes on while you are driving, pull over and stop carefully.

If the light stays on, have the vehicle towed for service. The brake system should be inspected right away.

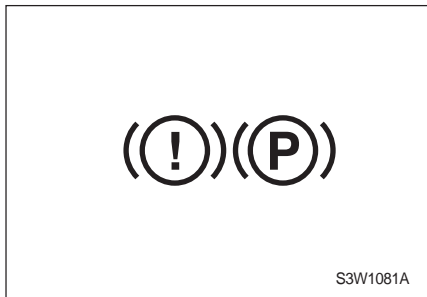

### ▲ CAUTION

**Driving with the brake warning light on can lead to an accident. Have the brakes checked immediately if the brake warning light stays on.**

This light also comes on when you set your parking brake while the ignition is ON.

The light stays on until the ignition is turned OFF or the parking brake is fully released.

Make sure the parking brake is fully released before driving the vehicle.

### ▲ WARNING

**Driving with the parking brake on can cause the brake system to overheat and may result in premature wear or damage to brake system components.**

**Always check that the parking brake is fully released before you begin to drive.**

If the warning light stays on after the parking brake is fully released, it means you may have a brake problem.

Check the brake fluid level.

**▲ CAUTION**

**Do not drive the vehicle if the brake warning light does not come on when the parking brake is engaged and the ignition is ON.**

If the light does not come on when the ignition is turned ON and the parking brake is engaged, you may have a problem.

See CHEVROLET retailer for service.

**MALFUNCTION INDICATOR LAMP (MIL)**

MIL illuminates as you turn the ignition ON, before you start the engine.

This means that the indicator bulb is operating properly.

The lamp should go off after the engine is started.

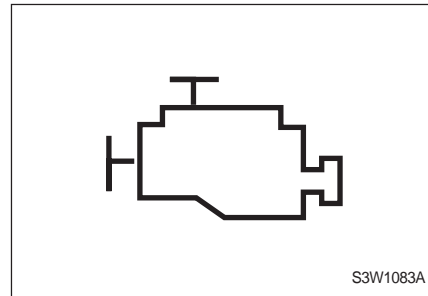

**▲ CAUTION**

- **Do not drive with the malfunction indicator lamp on.**

**The indicator lamp signals that your vehicle has a problem that requires attention. Driving with the malfunction indicator lamp on can damage the emissions control system and can affect the fuel economy and driveability of your vehicle.**

**Consult your CHEVROLET retailer to repair the problem as soon as possible.**

The Malfunction Indicator Lamp (MIL) will illuminate if a fault exists in the emission related components or related sub systems.

It will stay on as long as the Electronic Control Module (ECM) detects the fault. If a severe misfire level is detected, the MIL will blink continuously. Severe misfire can cause catalytic converter damage.

Your vehicle's electronic system will switch to an emergency running program so you may continue to drive.

### DIGITAL LOW FUEL LEVEL WARNING INDICATION

The low-fuel level warning indication will come on when there is approximately **4.3 to 5.0** liters of fuel remaining in the tank.

**▲ CAUTION**

- **Do not let your vehicle run out of fuel. This can damage the catalytic converter.**

Fill up the fuel tank as soon as possible when warning indication comes on.

### TURN SIGNAL INDICATORS/HAZARD WARNING FLASHER INDICATORS

Turn signal / hazard warning flasher indicators verify that the exterior turn signals or hazard warning flashers are working properly.

An arrow will flash in the direction of the turn or lane change when the turn signal is activated. Both arrows will flash when the hazard warning flasher is activated.

If the green arrows don't flash when you signal a turn or push the hazard warning button, check the fuse and the bulbs and replace any that are not operating properly.

### HIGH BEAM INDICATOR

The high beam indicator lamp turns on when the headlights are set to high beams.

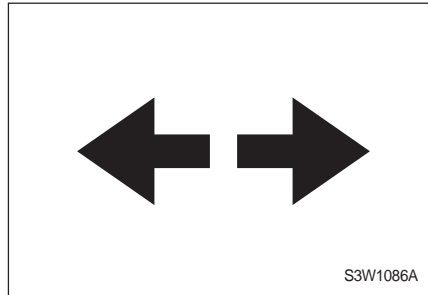
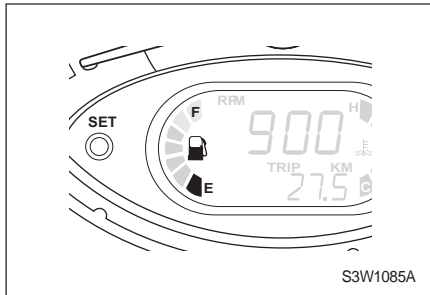

**FRONT FOG LIGHTS INDICATOR  
(Option)**

This light will come on when the fog lights are turned on.

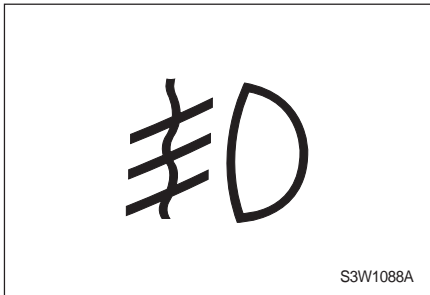
**DOOR AJAR WARNING LAMP**

This light illuminates when a door is open or not securely latched.

**LIGHTS****LIGHTS SWITCH**

The light controls are located on the exterior lights control lever. The light switch controls these light systems:



- Headlights
- Taillights
- Parking lights
- License lights
- Instrument panel lights

**▲ CAUTION**

**Make sure all exterior light bulbs, lamps, signaling systems, and warning indicators are clean and working properly to avoid accidents that could result in personal injury or damage to the vehicle.**

To turn the head, tail and parking lamps on or off, twist the end of the combination switch lever.

The light switch has three positions which activate various lamp functions as follows:

- **OFF:** All the lights are off.
-  : The parking lamps, tail lamps, license plate lamps, and instrument panel lamps are illuminated.
-  : The low-beam headlamps and all of the above lamps are illuminated.

The headlamps will turn off automatically when the ignition switch is turned to LOCK or ACC.

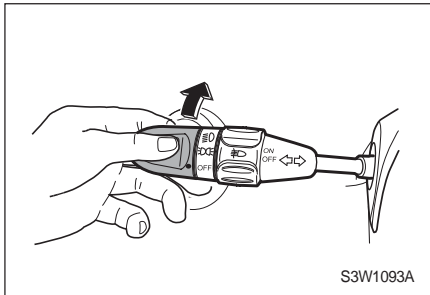

### TURN SIGNAL LEVER

**RIGHT turn:** Move the turn signal lever up.

**LEFT turn:** Move the turn signal lever down.

The turn signal will shut off automatically and the lever will return to its normal position (specific angle dependent) after you have completed the turn.

When changing lanes, move the turn signal lever part way and hold it there. When you release the lever, it will return to its normal position.

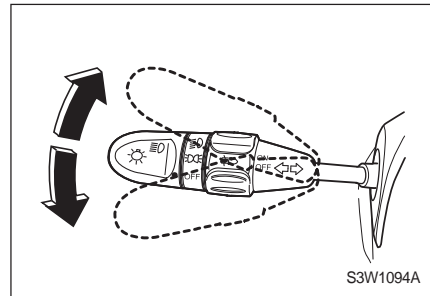

An arrow on the Indicator and Warning Lights Display will flash in the direction of the turn or lane change.

If the arrows don't flash, check for burned out indicator bulbs and check the fuse.

<p><b>▲ CAUTION</b></p> <p><b>These indicators are required for safe driving.</b></p> <p><b>Immediately replace any burned out indicator bulbs.</b></p> <p><b>Failure to keep the indicators in proper working condition can cause a collision resulting in personal injuries and damage to the vehicle or other property.</b></p>
------------------------------------------------------------------------------------------------------------------------------------------------------------------------------------------------------------------------------------------------------------------------------------------------------------------------------------

Shorter than usual flashes of the indicator lights mean that exterior turn signal bulbs may be burned out.

If a bulb is burned out, replace it to help avoid an accident.

## HIGH BEAM SWITCH

To turn the high-beam headlamps on:

- Make sure the low-beam headlamps are on.
- Push the combination switch lever towards the instrument panel.

The headlamp high-beam indicator illuminates when headlamps are on high beam.

To switch from high-beam headlamps to low-beam, pull the combination switch lever back towards you, to its normal position.

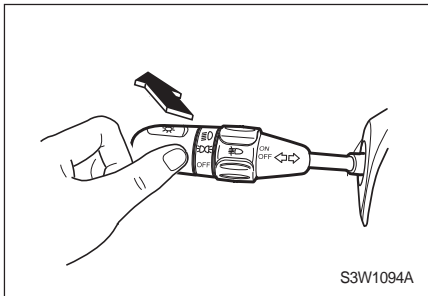

### ⚠ CAUTION

- **Always switch the high-beam headlamps to low-beam when you approach on coming vehicles or when other vehicles are ahead.**

**High-beam headlamps can temporarily blind other drivers, which could result in a collision.**

## PASSING LIGHT SWITCH

To flash the high-beam headlamps, pull the combination switch lever towards you and release it. The lever will return to its normal position when you release it.

The high-beam headlamps will stay on as long as you hold the combination switch lever towards you.

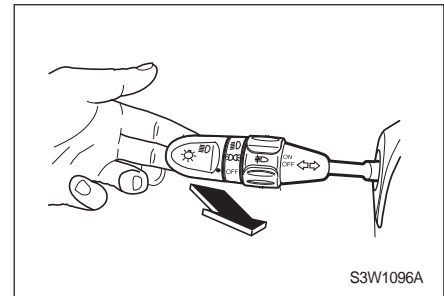

### FRONT FOG LAMP SWITCH (Option)

Fog lamps provide:

- Extra illumination to the sides of the road ahead.
- Improved visibility in fog or snow.

To turn the fog lamps on:

- Make sure that the parking lamp or headlamps are on.
- Turn the ring on the middle of the combination switch lever to ON.

The fog lamp indicator in the instrument panel illuminates when the fog lamps are turned on.

To turn the fog lamps off, turn the ring to the OFF position.

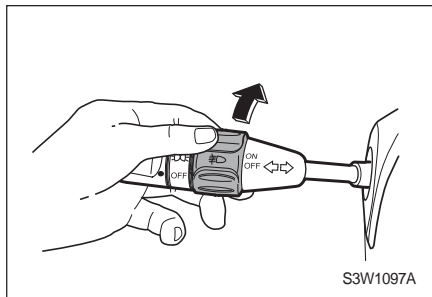

### HAZARD WARNING FLASHER SWITCH

Use hazard warning flashers in the following situations:

- To warn others of emergency conditions.
- When your vehicle is in a traffic hazard.

You can operate the hazard flash function with the ignition ON or OFF.

To activate the hazard warning flashers, push the hazard warning flasher switch.

To turn off the flashers, push the switch again.

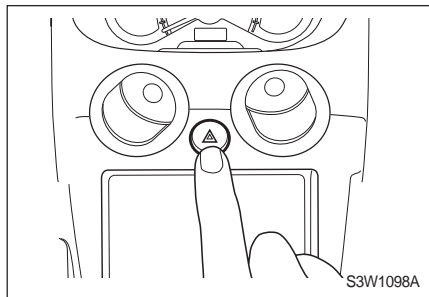

### HEADLAMP LEVELING SWITCH

Your headlights have a 4-position leveling dial located on the instrument panel near the steering column.

Adjust the dial position according to the vehicle load.

**0** : Front seats occupied

**1** : All seats occupied

**2** : Driver's seat occupied with a load in the luggage compartment.

**3** : All seats occupied with a load in the luggage compartment.

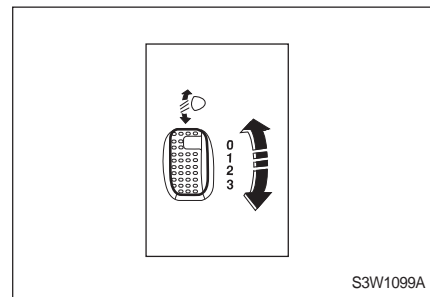

## WINDSHIELD WIPERS / WASHER LEVER

### WINDSHIELD WIPERS

#### ▲ CAUTION

- Less than clear vision for the driver can lead to an accident resulting in personal injury and damage to your vehicle or other property.
- Do not operate the windshield wipers when the windshield is dry or obstructed, as with snow or ice. Using the wipers on an obstructed windshield can damage the wiper blades, wiper motor, and glass.
- Check blades are not frozen to windshield before operating in cold weather. Wiper operation while blade is frozen can damage wiper motor.

To operate the windshield wipers, turn the ignition ON and move the windshield wiper/washer lever upward.

The windshield wipers operate in the following four positions:

- **OFF**: System off. Default position.
- **INT**: Intermittent operation. Lever up one level
- **LO**: Continuous wipe, slow speed. Lever up two levels.
- **HI**: Continuous wipe, fast speed. Lever up three levels.

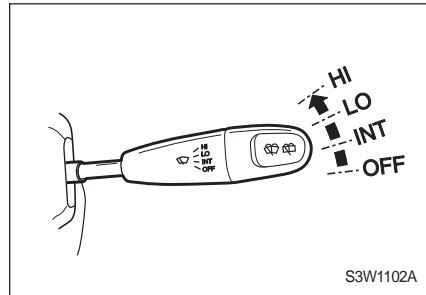

S3W1102A

#### NOTE

**Wiper blade will wear out and not wipe properly reducing forward vision.**

- **Replace worn wiper blades.**

#### Misting function

To operate the windshield wipers once in case of light rain or mist, lightly move the windshield wiper / washer lever towards the INT position and release it.

The lever will return automatically to its normal position when released.

The wipers will operate through one cycle.



### WINDSHIELD WASHER

**▲ CAUTION**

- **Less than clear vision for the driver can lead to an accident resulting in personal injury and damage to your vehicle or other property.**
- **Do not spray washer fluid on the windshield in freezing weather.**

**Washer fluid can form ice on a frozen windshield and obstruct your vision.**

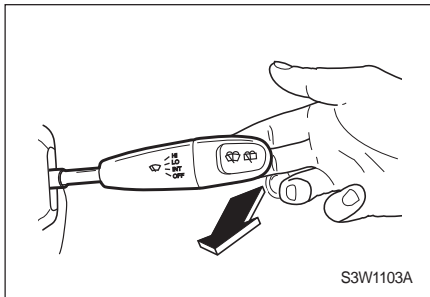

S3W1103A

To spray washer fluid on the windshield:

- Turn the ignition ON.
- Pull the windshield wiper/washer lever towards you.

When you pull the lever for less than 0.6 seconds, the following happens:

- Washer fluid sprays onto the windshield. (The windshield wipers do not operate)

When you pull the lever for more than 0.6 seconds:

- Washer fluid sprays onto the windshield.
- The windshield wipers operate for three cycles or until you release the lever.

**▲ CAUTION**

- **Do not operate the windshield washer continuously for more than 10 seconds, or when the washer fluid tank is empty.**

**This can cause the washer motor to overheat resulting in costly repairs.**

### REAR WINDOW DEFROSTER (Option)

**▲ CAUTION**

**Do not use the rear window defroster under the following conditions:**

- **Engine is not running.**
- **You are just starting your vehicle.**
- **There is a buildup of snow or ice on the rear window.**

**If you use your vehicle's rear window defroster under these conditions, you may discharge your vehicle's battery.**

**This can damage your vehicle, requiring the replacement of some parts.**

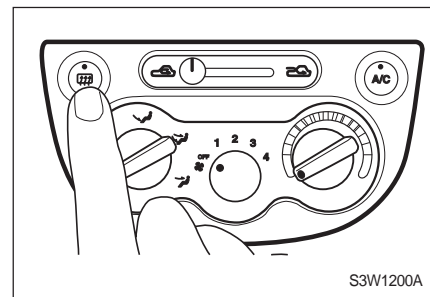

S3W1200A

## WINDOWS

### MANUAL WINDOWS

To turn the defroster on, start the engine and push the rear window defroster button. The indicator light in the button will illuminate.

To turn the defroster off, push the button again.

Make sure you turn the defroster off after achieving clear vision.

To raise or lower the windows, rotate the window regulator handle in the door panel.

The rear windows do not open fully.

Items can get trapped in windows. Ensure window opening is clear before closing windows.

#### ⚠ CAUTION

Lack of proper maintenance can damage your vehicle's defroster wires or scratch the glass.

- Do not use sharp instruments or abrasive window cleaners on your vehicle's rear window.
- Do not scratch or damage the defroster wires when you clean or work around the rear window.

Less than clear vision for the driver can lead to an accident resulting in personal injuries and damage to your vehicle or other property.

#### ⚠ WARNING

Unattended vehicle with open windows can assist car crime.

- Close all windows when leaving vehicle.

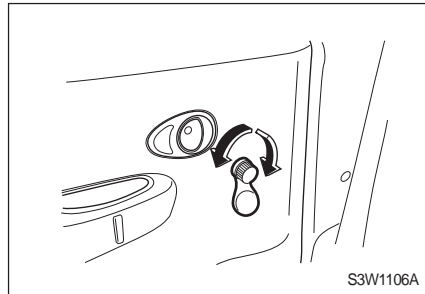

### POWER WINDOWS (Option)

You may operate the power windows when the ignition switch is ON by using the power window switches (if equipped) on each door panel.

#### ⚠ WARNING

Children can operate and become entrapped in power windows.

- Do not leave your keys or unattended children in your car.

Serious injury or death can occur from misuse of power windows.

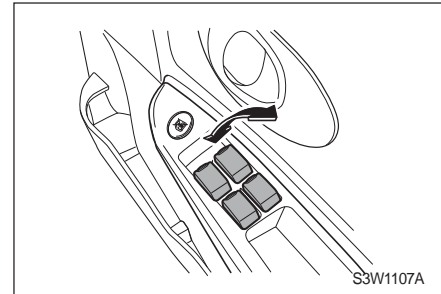

To raise the window, lift up on the switch.  
To lower the window, press down on the switch.  
Release the switch when the window reaches the desired position.

**▲ WARNING**

Body parts outside vehicle can be struck by passing objects.

- Keep all parts of body inside vehicle.

**NOTE**

The rear windows do not open fully. The rear power windows is not a standard fitment on all cars.

### POWER WINDOW LOCK BUTTON

The power window lock button allows you to lock the rear and passenger window buttons. With the lock on, the rear and passenger windows can only be operated from the driver's window control panel.

**▲ WARNING**

- Use power window lock when children are in back seat.

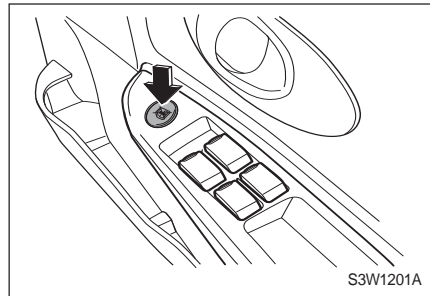

### KEYS

Two keys are provided with your new vehicle.

Keep one of the two keys as a spare. The key number is stamped on the key number plate. For vehicle security, keep the key number plate in a safe place, not in the vehicle. You should also record the key number in a safe place, not in the vehicle.

**▲ WARNING**

Do not leave the key in the vehicle.

- Lock the vehicle.
- Take the key with you.

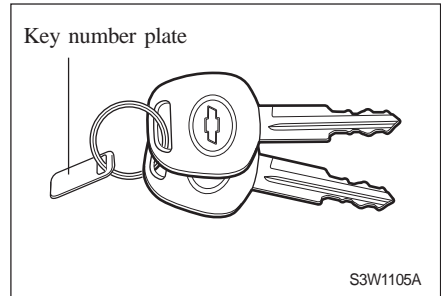

## DOOR LOCKS

### NOTE

In case of loss, replacement keys are available from CHEVROLET retailers.

### ▲ WARNING

The temperature inside vehicle can increase rapidly and reach much higher levels than temperature outside.

- Do not leave unattended children or pets in your vehicle.

Death or serious injury can occur.

Children can operate power windows, other controls, or move vehicle.

- Do not leave key in vehicle with children.

These actions can result in serious injury or death.

### ▲ CAUTION

- Lock all doors and take the key with you when you leave vehicle unattended.

Unlocked vehicles invite theft.

## MANUAL DOOR LOCKS

From the outside, use your key to lock or unlock the doors.

From the inside, use the manual door lock to lock and unlock each door individually.

If a front door is open and you use the manual door lock control to lock the door, you must keep the outside door handle raised as you close the door.

Driver door lock - Turn key clockwise to unlock and counter clockwise to lock the driver door.

Passenger door lock - Turn key clockwise to lock and counter clockwise to unlock the passenger door. This will lock or unlock passenger door only.

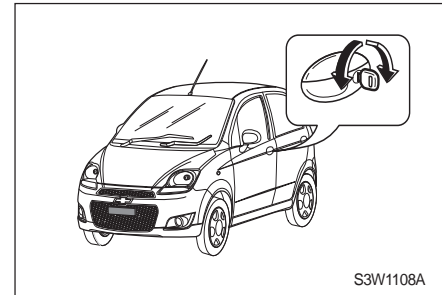

S3W1108A

### CENTRAL LOCKING SYSTEM (Option)

If your vehicle is equipped with the central locking system, you may lock or unlock all the doors at once.

To use this feature, do any of the following:

- From the outside, use your key to lock or unlock the driver's door.
- From the inside, use the manual door lock on the driver's door.

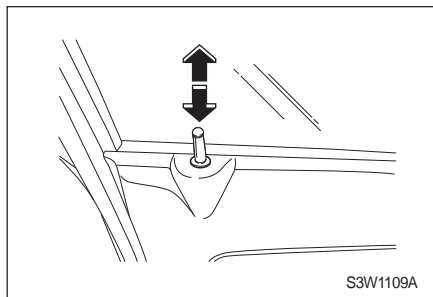

### REAR DOOR SECURITY LOCK

The rear doors are equipped with locks that help prevent passengers, especially children, from opening the rear doors from inside.

When the security lock is engaged, you can't unlock the door from the inside. But the door can only be opened from the outside.

The locks are located on the edge of each rear door. The door must be open to access the lock lever.

Move the lever on each rear door to the locked position to lock the doors.

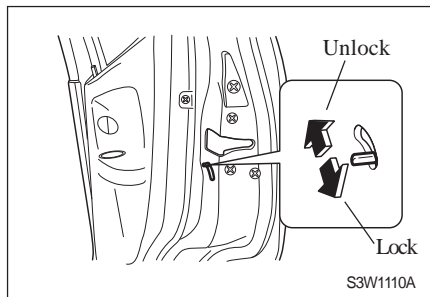

To unlock them, open each rear door from the outside and push the lever in the opposite direction.

#### ▲ NOTE

**Each rear door has its own lock.**

**Each rear door child security lock must be activated manually and separately, left and right.**

**Do not pull the inside door handle when the child security door lock is set to the lock position. This can damage the inside door handle.**

## REAR CARGO AREA

### ▲ CAUTION

**It can be very dangerous to drive with the tailgate open. Carbon monoxide (CO) gas can come into your vehicle. You cannot see or smell CO. It can cause unconsciousness and even death.**

**If you must drive with it open, make sure all other windows are closed and turn the fan on to the highest speed using any setting that brings in outside air. Doing this will force outside air into the vehicle.**

## TAILGATE

From the outside, use your key to unlock the Tailgate.

Turn key clockwise to unlock the tailgate.

To close tailgate, push it down so it latches securely. It locks automatically.

Make sure your hands and any other body parts, as well as those of other persons, are completely away from the trunk or tailgate closure area.

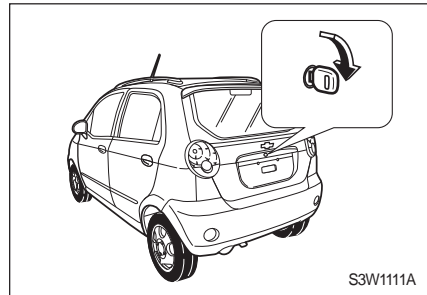

### ▲ CAUTION

**Be sure that tailgate doesn't hit any obstruction such as a standing person or wall, when you open the tailgate.**

### ▲ WARNING

**Driving vehicle with tailgate open can allow exhaust gases to enter passenger compartment.**

- **Do not drive with tailgate open. If you must drive this way then close windows and switch ON 'FRESH AIR MODE', and run blower at high speed.**

**Exhaust gases are usually poisonous and can cause injury or death.**

### TAILGATE RELEASE LEVER

You can also open the tailgate by pulling up the tailgate release lever located near the front right corner of the driver's seat.

#### **▲ WARNING**

- Do not operate the tailgate release lever while the vehicle is moving.
- Do not operate the vehicle with the tailgate open.

**An open tailgate obscures your rear view. Operating your vehicle with an obstructed rear view can result in a collision causing damage to your vehicle or other property, personal injury, or even death.**

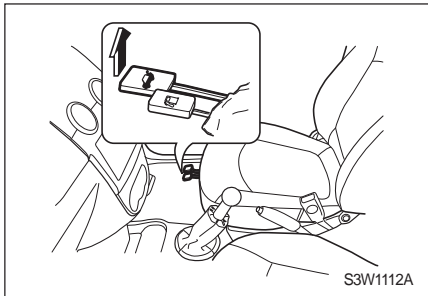

### HOOD RELEASE

To open the hood:

- Pull the handle inside the vehicle on the lower, driver's side of the instrument panel.

- Then pull up the secondary latch lever at the front of the vehicle and raise the hood.
- Disengage the hood support rod from the retaining clip.

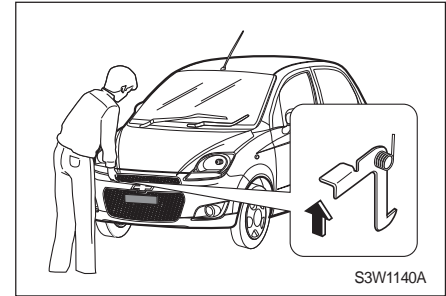
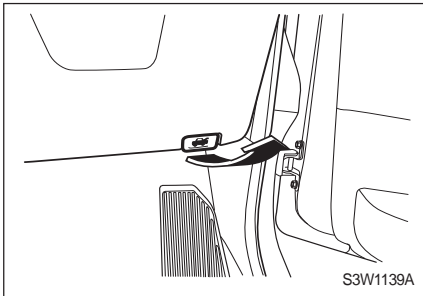

- Rotate the rod up and insert the free end securely into the socket on the underside of the hood.

To close the hood:

- While holding the hood to keep it from falling, remove the support rod from the socket and secure it firmly back into its retaining clip.
- Make sure hands and other body parts, as well as those of other persons, are completely away from the engine compartment and hood-to-body edges.
- Lower the hood, allowing it to drop from a height of about 30cm.
- Make sure that the hood is securely locked in place.

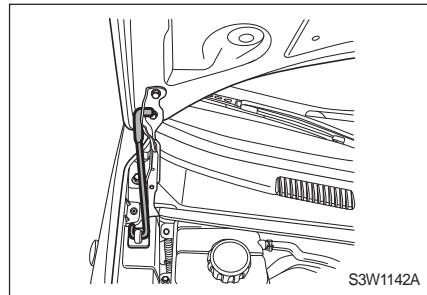
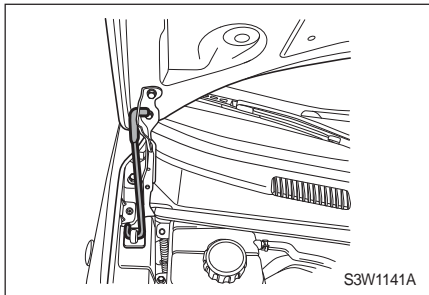

### ▲ CAUTION

**Pull on the front edge of the hood to make sure it is latched securely before you drive your vehicle.**

**Do not pull the hood release handle while your vehicle is moving.**

**Do not drive the vehicle with the hood open. An open hood will obscure the driver's vision.**

**Operating your vehicle with an obstructed view can lead to a collision resulting in damage to your vehicle or other property, personal injury, or even death.**

**Be careful not to drop or spill things that will burn onto a hot engine. They could start a fire and you or others could be burned.**

**Fans or other moving engine parts can injure you badly. Keep your hands, hair and loose clothing away from moving parts.**



## DOME LAMP

The dome lamp operates in three positions:

- **ON:** The lamp comes on and stays on until shut off manually.
- **CENTER:** The lamp comes on when you open a door and off after doors are closed.
- **OFF:** The lamp remains off, even when doors are open.

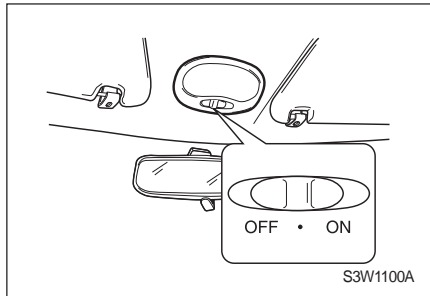

## ASHTRAY (Option)

The ashtray is removable and fits in the front cupholder. To open the ashtray, lift the cover.

To remove the ashtray, rotate the upper part of the ashtray and then pull the ashtray out.

**▲ CAUTION**

**Do not put papers and other things that burn into the ashtrays. If you do, cigarettes placed in the ashtrays could start them on fire.**

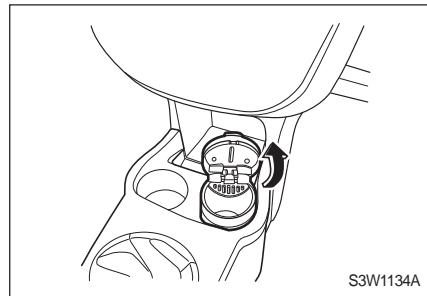

## CIGARETTE LIGHTER (Option)

To operate the cigarette lighter:

- Turn the ignition switch to ACC or ON.
- Push the lighter in all the way.

The cigarette lighter will pop out automatically when it is ready to use.

**▲ CAUTION**

**The barrel of an operating cigarette lighter can become very hot.**

**Do not touch the barrel as hot metal can cause personal injuries and damage to your vehicle or other property.**

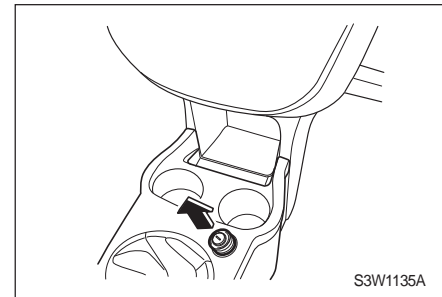

## HORN

### ▲ CAUTION

Overheating the cigarette lighter can damage the heating element and the lighter itself.

- Do not hold the lighter in while it is heating.

This can cause the lighter to overheat.

### ▲ CAUTION

Trying to operate a malfunctioning cigarette lighter can be dangerous.

- If the heated cigarette lighter does not pop out within 30 seconds, pull it out and ask your CHEVROLET retailer to repair it.

It can cause injuries and damage to your vehicle.

To operate the horn, press the center pad of steering wheel of the vehicle.

The horn will sound regardless of ignition switch position.

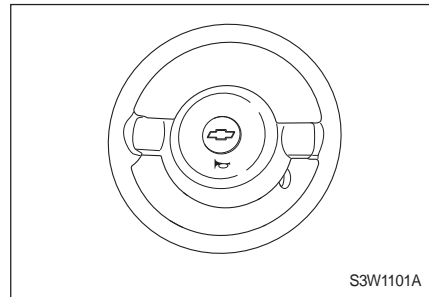

S3W1101A

## STORAGE

### GLOVE BOX

The glove box can be used to store small items.

To open the glove box, pull upward on the bottom of the handle on the glove box door.

To close the glove box, firmly push the glove box door.

### ▲ CAUTION

In the case of a collision or a sudden stop, an open glove box can cause personal injuries or damage to your vehicle.

Do not drive with the glove box open.

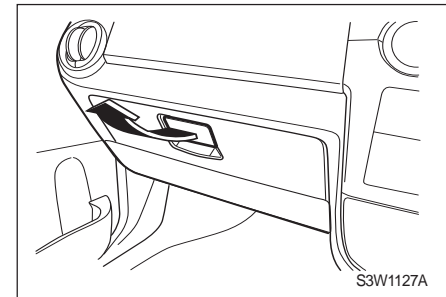

S3W1127A

### CUP HOLDERS

There are two cupholders at the front of the center console.

There is also a cupholder for the rear seat passengers located on the rear of the center console.

**▲ CAUTION**

**Do not use a cup holder while the vehicle is in motion. Liquid may spill out and damage the vehicle or cause burns if it is hot.**

### SHOPPING HOOKS

Your vehicle is equipped with seatback shopping hooks on each front seatback. Plastic grocery bags or other suitable objects can be attached to the hooks.

### SUN VISORS (Option)

Your vehicle has padded sun visors to protect the driver and passengers from glare.

You can swing the sun visors up and down, and to the side.

The vanity mirror\* has been provided on the back of passenger sun visor.

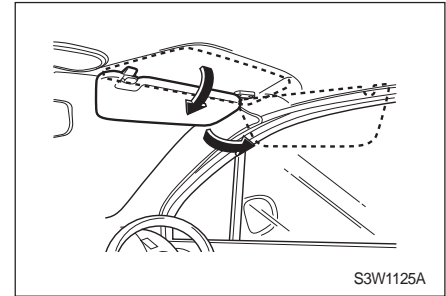
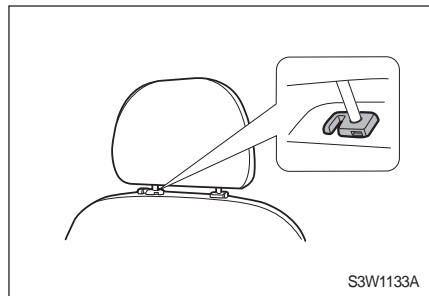
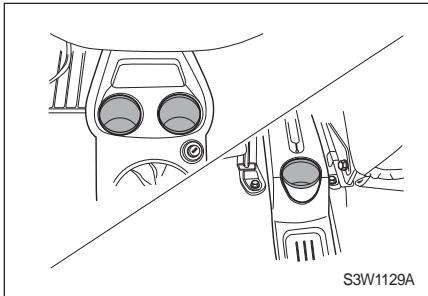

## ASSIST HANDLES

Your vehicle has assist handles above the front seat passenger door and the rear doors.

### ▲ CAUTION

**Hanging items on assist handles can obstruct the driver's view. Do not hang anything on an assist handle unless the handle is equipped with a coat hook.**

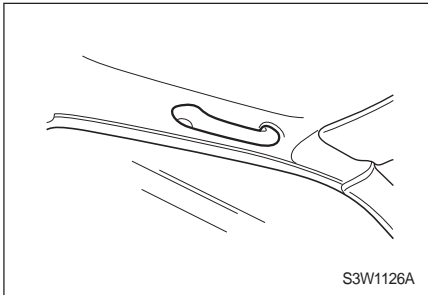

## LUGGAGE CARRIER (Option)

Use the luggage carrier to load things on top of your vehicle.

There are side rails attached to the roof. The luggage carrier may also be equipped with crossrails.

The carrying capacity of the luggage carrier is 50 kg (110 lbs.) when the vehicle is loaded with up to four occupants. When you carry cargo on the luggage carrier, distribute the weight evenly.

Do not load cargo directly onto the roof of your vehicle.

Do not exceed the maximum vehicle capacity when loading your vehicle.

A loaded luggage carrier changes the center of gravity of the vehicle. Do not drive at high speeds. Also, be careful when driving in crosswinds.

To prevent damage or loss of cargo while driving, check periodically to make sure that the luggage carrier and cargo are still securely fastened.

For more information on the luggage carrier or regulations on driving with a loaded

luggage carrier, see your CHEVROLET retailer.

### ▲ CAUTION

**If you try to carry something on top of your vehicle that is longer or wider than the luggage carrier - like paneling, plywood, a mattress, and so forth - the wind can catch it as you drive along. What you are carrying could be violently torn off, and this could cause you or other drivers to have a collision, and of course damage your vehicle. Never carry something longer or wider than your luggage carrier on top of your vehicle.**

### **ROOF RAIL (Option)**

It is an accessory design with a dynamic and a sporty appearance.

# 4 HEATING & AIR CONDITIONING

---

- AIR VENTS ..... 4-2
- CONTROL PANEL ..... 4-3
- AIR CONDITIONING ..... 4-7
- HEATING ..... 4-8
- VENTILATION ..... 4-9
- AIR OUTLET ..... 4-10
- OPERATING TIPS ..... 4-10
- REAR WINDOW DEFOGGER (Option) ..... 4-11

## AIR VENTS

### Side vents

You can direct air through both adjustable side vents towards either side of the front passenger area, or towards the side windows.

### Windshield defroster vents

The windshield defroster vents direct air onto the windshield.

### Center vents

You can control the direction of airflow through both adjustable center vents.

### Floor vents

The floor vents direct air into the front foot area.

### Front door window defroster vents

The front door window defroster vents direct air onto the side windows, mainly in the area near the outside mirror.

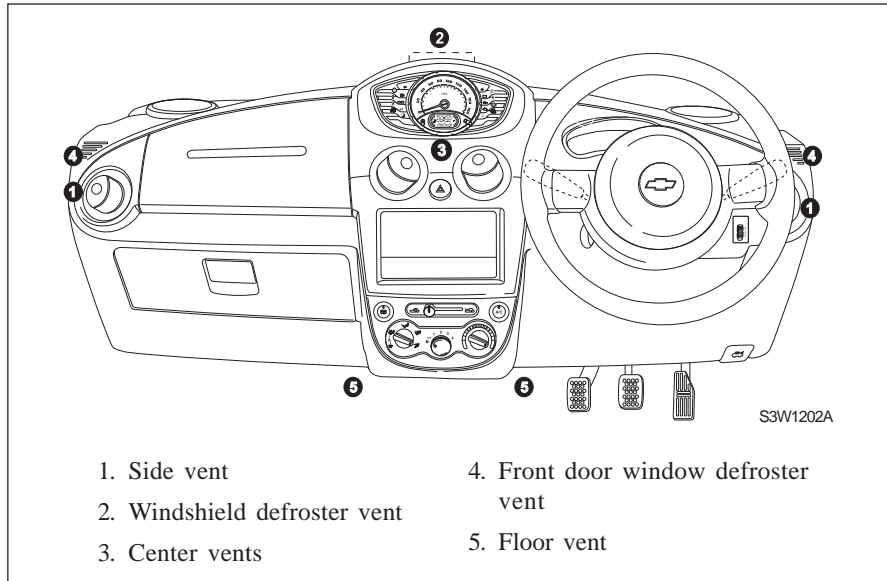

## CONTROL PANEL

1. Temperature control knob.
2. Fan speed control knob.
3. Air distribution mode knob.
4. Air conditioning (A/C) button.
5. Recirculation mode lever.
6. Rear window defroster button (Option).

## TEMPERATURE CONTROL KNOB

The temperature control knob controls the temperature of the air that comes through the air vents.

Turn the knob to the blue area to get cool air and to the red area to get warm air.

(Heater + A/C)

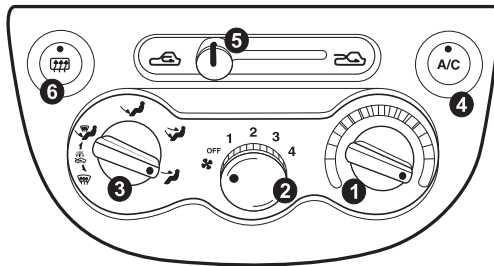

S3W1113A

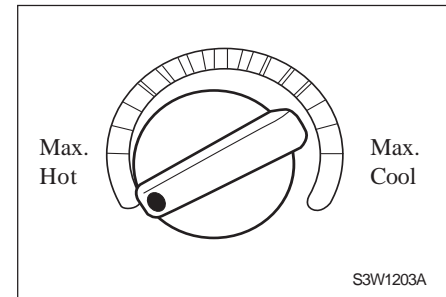

S3W1203A



### FAN SPEED CONTROL KNOB

You may control the rate of airflow coming from the system by turning the fan speed control knob. Turn the knob clockwise to increase the fan speed and counterclockwise to decrease the fan speed.

Adjust the fan control knob from step 1 to step 4 as you wish.

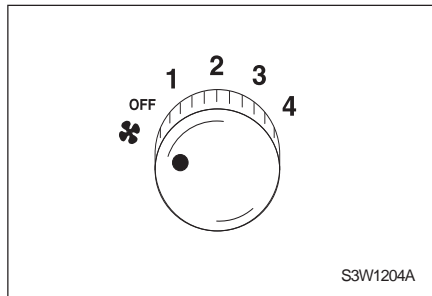

### AIR DISTRIBUTION MODE KNOB

Adjust the air distribution knob to the desired mode which you want to direct the air flow.

The air distribution knob can be set in one of five positions:

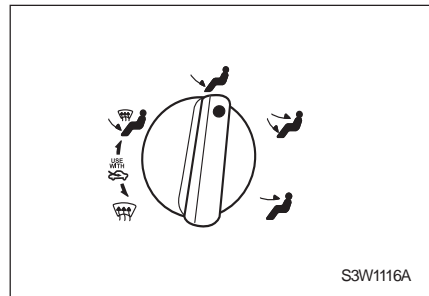

### Front ( → )

This setting directs air through center and side vents.

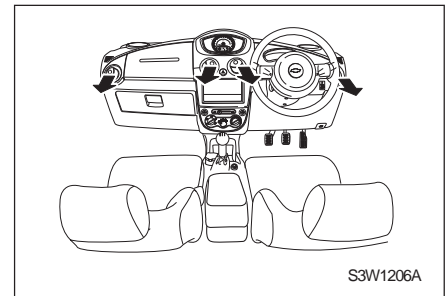

**Bi-level (↕)**

Directs air in two ways. Half of the air through the floor vents and the remaining through the center and side vents.

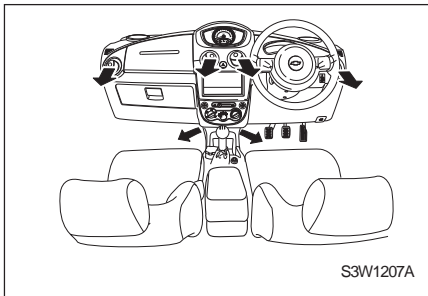
**Floor (↕)**

Directs most of air through the floor vents. Keep the area under the front seats clear in order not to block the airflow.

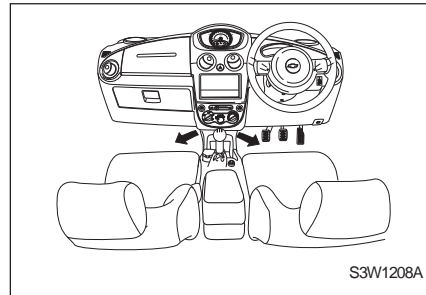
**Floor/Defrost (↕)**

This mode directs air through windshield defroster vents, front door window defroster vents and the floor vents.

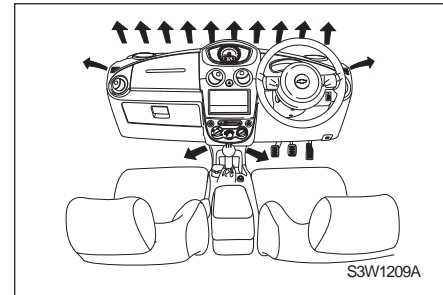

**Defrost (  )**

Directs air through the windshield and front door window defroster vents.

**RECIRCULATION MODE LEVER**

Slide the lever to  to recirculate the air in your vehicle. This is useful for keeping the dust out or when quick heating or cooling is desired.

**Your windows may fog if you use the recirculation mode for extended periods. If this happens, slide the recirculation mode lever to the outside air mode.**

Slide the lever to  to circulate outside air into your vehicle.

**▲ CAUTION**

**The exchange of fresh air is reduced in air recirculation mode. In operation without cooling the air humidity increases, so the windows may mist up. The quality of the passenger compartment air deteriorates, which may cause the vehicle occupants to feel drowsy.**

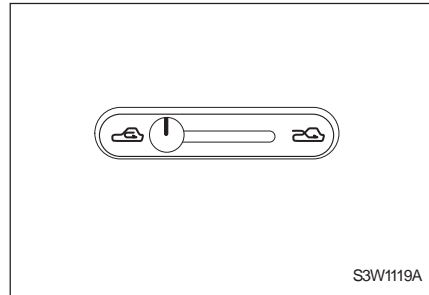
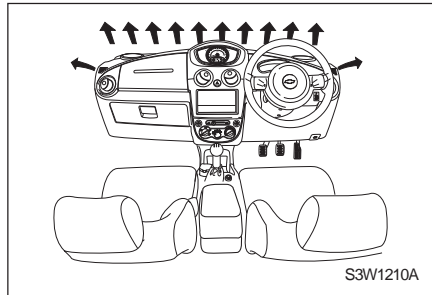

## AIR CONDITIONING

The refrigeration unit of the air conditioning (A/C) system cools and removes moisture and dust from the air inside your vehicle.

Even with the A/C on, your vehicle will produce warm air if you set the temperature control knob to warm.

### NOTE

You may notice water drip under engine room sometimes after driving with A/C on. This is normal because your cooling system removes the moisture from the air.

### NOTE

Because the compressor of the cooling system shares the engine power, you may notice slight change in engine power and performance when the compressor operates.

### A/C BUTTON

#### ▲ CAUTION

Using your air conditioning (A/C) system while driving up long hills or in heavy traffic can cause the engine overheating.

- Watch temperature gauge.
- Turn OFF the A/C if the gauge indicates engine overheating.

Vehicle can be damaged.

### NOTE

The air conditioning will not operate when the fan speed control knob is in the off position.

### To turn on the Air Conditioning (A/C):

1. Start the engine.
2. Press A/C button. (Indicator light will come on to confirm the A/C is running.)
3. Adjust fan speed.

### To turn off the A/C:

Press A/C button again. (Indicator light will go off to confirm the A/C is not running.)

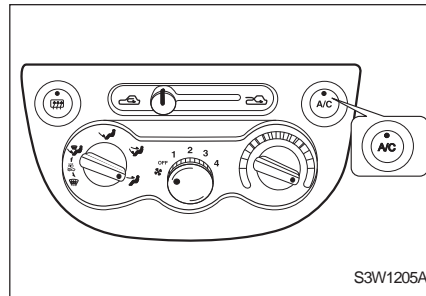



## COOLING

### Maximum cooling

To achieve maximum cooling during hot weather and when your vehicle has been exposed to the sun for a long time:

1. Open windows slightly to let warm air escape.
2. Turn air conditioning (A/C) on. (Indicator illuminates)
3. Slide the recirculation lever to recirculation mode.
4. Turn air distribution knob to FRONT mode (  ).
5. Turn temperature control knob all the way to the blue area for cooling.
6. Turn fan speed control knob to highest speed.

### Normal cooling



1. Turn on the air conditioning (A/C) button. (Indicator illuminates)
2. Slide the recirculation lever to recirculation mode.
3. Turn the air distribution knob to FRONT (  ) or BI-LEVEL (  ).
4. Turn temperature control knob to blue area for cooling.
5. Adjust the fan speed control knob to the desired speed.

## HEATING

### Maximum heating

Use the maximum heating mode for quick heating of the passenger area. Do not use it for lengthy periods because the interior air may become stale and the windows may fog. To clear the windows, slide the recirculation mode lever to outside air mode to allow fresh air into the vehicle.



For maximum heating:

1. Turn off air conditioning (A/C). (Indicator goes off)
2. Slide the recirculation lever to recirculation mode.
3. Turn air distribution knob to BI-LEVEL (  ) or FLOOR (  ).
4. Turn temperature control knob all the way to the red area for heating
5. Turn fan speed control knob to maximum speed.

---

## VENTILATION

### Normal heating

1. Turn off air conditioning (A/C). (Indicator goes off)
2. Slide the recirculation lever to outside air mode.
3. Turn air distribution knob to FLOOR () or BI-LEVEL () .
4. Turn temperature control knob to red area for heating.
5. Turn fan speed control knob to desired speed.

### Bi-level



Use this setting on cool, but sunny days. Warmer air will flow into the floor area and cool outside air will flow towards your upper body.

To use this setting:

1. Slide the recirculation lever to outside air mode.
2. Turn air distribution knob to BI-LEVEL () .
3. Adjust temperature control knob to the desired temperature.
4. Turn fan speed control knob to the desired speed.

### Ventilation

To direct air through the center and side vents:

1. Turn off air conditioning (A/C). (Indicator goes off)
2. Slide the recirculation lever to outside air mode.
3. Turn the air distribution knob to FRONT () or BI-LEVEL () .
4. Turn temperature control knob to blue area for cooling.
5. Turn fan speed control knob to desired speed.

## AIR OUTLETS

To open an outlet, press on its cover. Rotate the cover to direct airflow as desired.

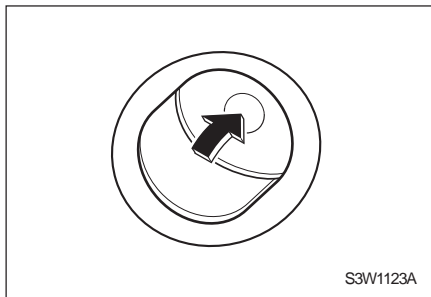

## OPERATING TIPS

- Before using the air conditioning system, open the windows for a few minutes to permit hot air to escape if the vehicle has been parked in direct sunlight.
- For maximum cooling, select the ventilation mode and the highest fan speed. Make sure that the air conditioning compressor is turned on. Then rotate the temperature control knob to select the coolest temperature and select the recirculation mode.
- To defog the windows on rainy days or in high humidity, turn on the air conditioning compressor.
- Turn on the air conditioning for a few minutes at least once a week, even in the winter or when the air conditioning system is not being used regularly. This maintains proper lubrication of the compressor and seals, prolonging the service life of the system.
- Driving in stop-and-go traffic may reduce the effectiveness of the air conditioning system.
- To quickly defog or defrost the front windshield, use the defrosting mode, set the temperature to warm, and set the fan at the highest speed.
- Defroster mode will operate with the air conditioner on or off.
- Turn the air conditioner on to improve the efficiency of the defroster.
- Do not use the heating/defogging mode or the defrosting mode in extremely humid weather when the temperature control is set to cold.

## REAR WINDOW DEFOGGER (Option)

The ignition must be ON for this feature to work.

Press this button to defog your rear window. To turn it off, press the button again.

The indicator light in the button will glow when the system is on. Be sure to turn the defogger off after the window is clear.

### ▲ CAUTION

Less than clear vision for the driver can lead to an accident resulting in personal injury and damage to your vehicle or other property.

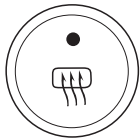

S3W1124A

### NOTE

**Do not use the rear window defogger under the following conditions:**

- Engine is not running.
- You are just starting your vehicle.
- There is a buildup of snow or ice on the rear window.

Operating the rear window defogger under these conditions could drain the battery. This can damage your vehicle, requiring the replacement of some parts.

Don't use a razor blade or anything else that is sharp on the inside of the rear window. Do not use abrasive window cleaners on the rear window. You could cut, scratch or damage the warming grid.





# 5

## DRIVING YOUR VEHICLE

---

- BREAKING-IN ..... 5-2
- DRIVING PRECAUTIONS ..... 5-2
- FUEL ..... 5-4
- ADJUSTING THE MIRRORS ..... 5-6
- IGNITION SWITCH ..... 5-8
- STARTING THE ENGINE ..... 5-9
- DRIVING YOUR VEHICLE ..... 5-10
- BRAKES ..... 5-11
- DRIVING TIPS ..... 5-13
- ENGINE EXHAUST ..... 5-15

## BREAKING-IN

Use the following precautions for the first few hundred kilometers to improve the performance and economy of your vehicle and add to its long life:

- Avoid full-throttle starts.
- Allow the engine to warm up before driving.
- Do not race the engine.
- Avoid hard stops except in emergencies. This will allow your brakes to break-in properly.
- Avoid quick starts, sudden accelerations, and prolonged high-speed driving in order to avoid damage to the engine and to conserve fuel.
- Avoid full-throttle acceleration in low gear.
- Do not tow any other vehicle.

## DRIVING PRECAUTIONS

### BEFORE ENTERING THE VEHICLE

#### ▲ WARNING

- **Make sure all exterior light bulbs, lamps, signaling systems, and warning indicators are clean and working properly.**

**These precautions help to avoid accidents that could result in personal injury or damage to the vehicle.**

- Be sure all windows, inside and outside rearview mirrors, light bulbs, and lamps are clean and working properly.
- Check under the vehicle for leaks.
- Check the levels of engine oil and other fluids in the engine compartment.
- Visually check the tires for damage or improper inflation pressures and for foreign objects imbedded in the tread.
- Take corrective actions as required.

### BEFORE DRIVING

#### ▲ WARNING

**Loose objects on the instrument panel can obstruct your vision.**

- **Remove any loose objects on the instrument panel .**

**These objects can also be thrown around and strike passengers during hard braking or a collision, causing personal injury or damage to your vehicle.**

- Be sure you understand your vehicle, its equipment and its safe operation.
- Adjust your seat to a comfortable position.
- Adjust the inside and outside mirrors.
- Be sure all occupants of the vehicle have fastened their safety belts.
- Check the operation of the warning lights as the ignition key is turned ON.
- Check all the gauges.
- Release the parking brake, making sure the warning lamp goes out.

## WHILE DRIVING

As the driver of your vehicle, you are responsible for the safety of yourself, your passengers and others sharing the road with you. To discharge that responsibility, you must keep your full attention on operating the vehicle. Most vehicular collisions are caused when a driver's concentration is either impaired or distracted. At all times, the driver's concentration should be upon the road and nearby vehicles and other objects.

One significant distraction in today's driving environment is the use of hand-held phones while driving. Studies have found that the use of hand-held phones while driving increases the risk of being involved in an accident. At least one scientific study found that use of any phone system— either hand-held or hands-free— increases the risk of a collision by 400%.

Using phones, two-way radios or other electronic devices such as computers, organizers, games, video, or GPS and other navigational aids similarly increases the risk of collision. We discourage your use

of equipment while you are operating your vehicle.

### ▲ WARNING

**Driving safely requires all of your concentration as well as the application of good judgment and common sense. Avoid or minimize distractions while operating your vehicle. Distractions you may encounter could include:**

- responding to calls on your cell or car phone;
- initiating calls on your cell or car phone;
- making adjustments to your seat, steering wheel or mirrors;
- using other electronic devices;
- referring to maps or other written materials;

(Continued)

### ▲ WARNING

(Continued)

- removing or connecting your safety belt;
- searching for change approaching toll booths; or
- other activities that divert your attention from the task of safe vehicular operation.

**Engaging in such activities will greatly increase the risk of a collision that may cause personal injury or death.**

**Anticipate the need for such activities and perform them before you start your trip when possible, or while your vehicle is safely at a stop.**

## FUEL

### FUEL RECOMMENDATIONS

Fuel quality and additives contained in fuel have a significant effect on power output, driveability, and life of the engine.

Fuel with too low an Octane number can cause engine knock. Use of 87 or higher Octane rating fuel is recommended.

The use of gasoline with an Octane rating lower than 87 may cause engine to knock. Continued use may cause engine damage and manufacturer warranty stands void. Contact your CHEVROLET retailer to fix your car, incase of usage of lower or higher Octane rating fuel other than General Motors India recommendation.

#### ▲ CAUTION

- Use of fuel with low quality or too low octane number may damage the engine.
- Use of leaded fuel in our unleaded vehicles will damage exhaust system and invalidate the warranty.

### FUEL DOOR RELEASE

The remote fuel filler door release allows you to open the fuel filler door from inside the vehicle. Pull up the release lever located near the front corner of the driver's seat.

#### NOTE

**If the fuel filler door does not open in cold weather, tap the door lightly. Then try to open it again.**

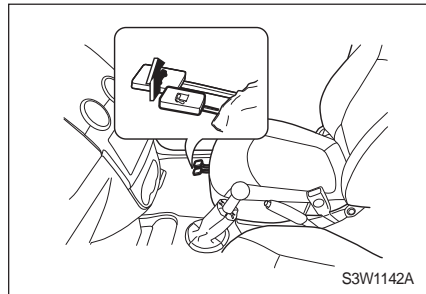

### FILLING THE FUEL TANK

1. Stop the engine.
2. Pull up on fuel filler door release lever located on the floor, front right side of driver's seat.
3. Turn the fuel filler cap counterclockwise slowly. If a hissing sound is heard, wait for it to stop before completely unscrewing the cap. The fuel filler door is in the right rear quarter panel.
4. Remove the cap. The cap is tethered to the vehicle.

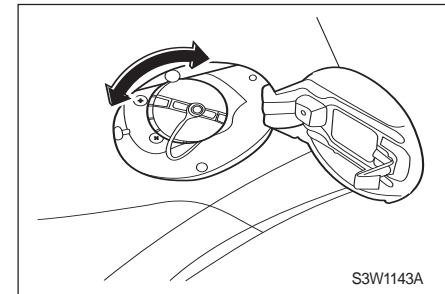

5. After refueling, refit cap. Turn it clockwise until you hear several clicks.
6. Push the fuel filler door closed until it latches.

**NOTE**

If, in cold weather, the fuel filler door does not open, tap the door lightly. Then try to open it again.

**▲ WARNING**

Fuel vapor is highly flammable.

- Keep flames, sparks and other smoking materials away from gasoline.
- Turn off your engine.

You can be seriously burned and your vehicle damaged when gasoline vapor catches fire.

**▲ CAUTION**

Avoid spilling gasoline on the painted surfaces of your car.

- If you spill gasoline on your vehicle, rinse the area with clean, cold water as soon as possible.
- Gasoline can damage the paint.

**Fuel filling from drums or portable containers****▲ WARNING**

For safety reasons, fuel containers, pumps and hoses must be properly earthed. Static electricity build up can ignite the gasoline vapor. You can be burned and your vehicle damaged.

Always observe the following precautions:

- Use earthed pumps with integrally earthed hoses and containers when filling the fuel tank.
- Do not fill your container when it is inside your vehicle other than on the ground.
- Make the filling nozzle in contact with the inside of the container opening before operating the nozzle. Keep the contact be maintained until you finish filling the container.
- Keep flames, sparks and smoking materials away from gasoline.

## ADJUSTING THE MIRRORS

### OUTSIDE REARVIEW MIRRORS

Adjust the outside rearview mirrors so you can see each side of your vehicle, as well as each side of the road behind you.

You may adjust the outside rearview mirrors up or down and left or right using the adjusting levers on each door trim.

Both outside mirrors (if equipped) are convex and is labeled with a notice that reads as follows:

**OBJECTS IN MIRROR ARE  
CLOSER THAN THEY APPEAR.**

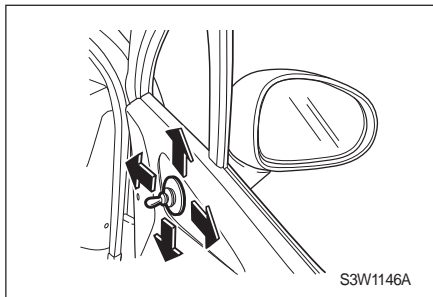

Use the outside mirrors to get a wider view of the road behind your vehicle.

Use the inside mirror to determine the size and the distance of objects reflected in the side mirror.

Using only outside mirrors can cause you to misjudge size and distance behind you.

#### **▲ WARNING**

- **Always keep your mirrors properly adjusted, and use them while driving to increase your visibility of objects and other vehicles around you.**

**Failure to properly judge distances between your vehicle and other objects may result in a collision causing damage to your vehicle or other property, or injuries.**

#### **▲ CAUTION**

**Improper care of your mirrors can damage them.**

- **Do not scrape ice from the face of the mirror.**
- **If ice or other material restricts movement of the mirror, do not force the adjustment.**
- **Use a deicer spray or a hot air blower to remove the ice.**

**Damaged mirrors can restrict your vision, resulting in a possible collision.**

You may fold the outside rearview mirrors flat against the sides of the vehicle by pushing the mirrors backward against your vehicle.

**▲ WARNING**

- **Do not drive while either outside rearview mirror is folded back.**

**Doing so will cause reduced visibility, which could result in a collision.**

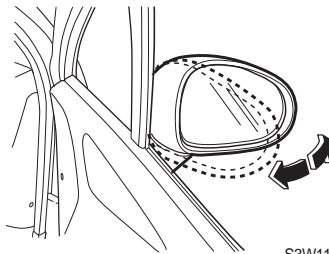

S3W1145A

### INSIDE REARVIEW MIRROR

The inside rearview mirror can be adjusted manually up or down and left or right.

#### Day/ Night Tilt Function (Option)

Use the inside rearview mirror adjusting lever to modify the mirror for day / night vision. This reduces glare from headlights on vehicles behind you.

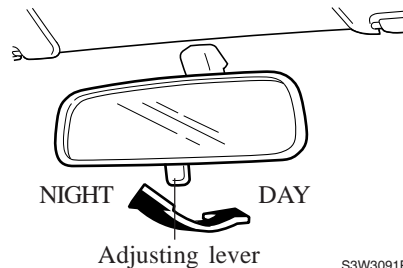

S3W3091P

**▲ WARNING**

**Your view through the mirror may lose some clarity when it is adjusted for night vision.**

- **Take special care with using your inside rearview mirror when it is adjusted for night vision.**

**Failure to ensure a clear rear view while driving may result in a collision causing damage to your vehicle or other property, and/or personal injury.**



## IGNITION SWITCH

The ignition switch, located on the right side of the steering column, has the following positions: LOCK, ACC, ON and START.

### • LOCK

To lock the steering wheel, remove the key and rotate the steering wheel until it locks.

For easier key operation when unlocking the steering wheel, move the steering wheel gently from right to left and turn the key to the ACC position.

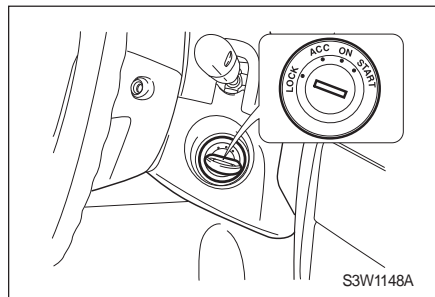

### • ACC

The engine can be turned off without locking the steering wheel by turning the key to the ACC position.

Some electrical accessories, such as the radio (if equipped) and the cigarette lighter, can be operated in the ACC position.

#### ▲ CAUTION

- Do not leave the key in the ACC for extended periods.

**This will discharge the battery.**

### • ON

Activates the ignition system and the electrical accessories.

#### ▲ CAUTION

- Do not leave the key in the ON for extended periods while the engine is not running.

**This will discharge the battery.**

### • START

Starts the engine. When the engine starts, release the key, and it will automatically return to ON.

Make sure that the engine is not running before turning the key to START.

#### ▲ WARNING

- Do not turn the key to OFF while driving.

**Driver could lose control of vehicle and brake power assistance would be cancelled, causing vehicle damage, personal injury or possibly death.**

#### ▲ WARNING

- Do not reach for the key through the steering wheel.

**Steering wheel can suddenly turn causing driver to lose control of vehicle and causing injury to fingers, hands or arms.**

## STARTING THE ENGINE

### BEFORE STARTING THE ENGINE

- Make sure the area around vehicle is clear.
- Make sure all windows and lights are clear.
- Inspect tires for condition, proper inflation pressure and foreign objects.
- Adjust seat positions and head restraints.
- Adjust inside and outside mirrors.
- Fasten safety belt and ask all passengers to do the same.
- Check the operation of warning lights and indicators in the instrument panel when the key is turned to ON position.
- Periodically, such as when refueling, check maintenance items noted in this Manual.

#### ▲ CAUTION

- **Do not operate starter motor for more than 15 seconds at a time.**
  - **If the engine does not start, wait 10 seconds before trying again.**
- This will prevent starter motor damage.**

#### ▲ CAUTION

- **Do not idle the engine at high rpm for more than 3 minutes.**
- Excessive temperature can damage the exhaust system/catalytic converter.**

#### NOTE

**If the engine has become flooded during starting, slowly press the accelerator pedal all the way down, hold it in that position, and start the engine.**

### MANUAL TRANSAXLE

1. Make sure the driver and passengers are wearing their safety belts properly.
2. Apply parking brake if it is not engaged.
3. Make sure the seats, head restraints, and mirrors are in their proper positions and adjust them if it is required.
4. Make sure the gearshift lever is in NEUTRAL position and press the clutch pedal all the way down.

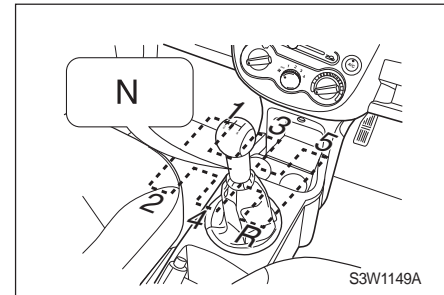

## DRIVING YOUR VEHICLE

### MANUAL TRANSAXLE

- Without touching the accelerator pedal, turn the ignition to **START** and release it when the engine starts. If the engine starts momentarily but fails to run, wait for 10 seconds, then try again.
- Allow the engine to idle at least 30 seconds.
- Release the parking brake.
- Drive at a moderate speed for a short distance, especially in cold weather until normal engine operating temperature is reached.

To change gears, fully depress the clutch pedal, move the gearshift lever into gear, and slowly release the clutch pedal.

#### ▲ CAUTION

- **Before shifting between a forward and reverse, bring the vehicle to a complete stop.**

**Shifting between forward and reverse gear while the vehicle is moving can damage the transaxle.**

#### ▲ CAUTION

- **Do not rest your foot on the clutch pedal while driving.**

**This will cause accelerated wear on clutch components.**

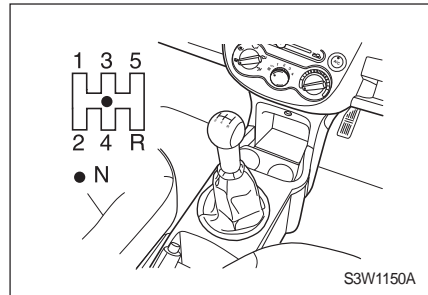

## BRAKES

The braking system is designed for braking performance under a wide range of driving conditions.

Your vehicle is equipped with front disc and rear drum brakes and a dual circuit braking system.

If one brake circuit fails, the vehicle can still be stopped with the remaining circuit, however, stopping distance will be increased and more brake pedal pressure will be required.

### ▲ WARNING

**If one of circuit fails, the brake pedal must be pressed with greater pedal pressure and the braking distance is increased.**

- **Have the brake system checked and repaired by a CHEVROLET retailer immediately.**

### ▲ WARNING

**If the brake pedal can be pressed further than normal, the brakes may be in need of repair.**

- **Consult your CHEVROLET retailer immediately.**

### ▲ CAUTION

- **Do not drive with your foot resting on the brake pedal.**

**Doing so will accelerate wear of brake components. The brakes may also become overheated, resulting in longer braking distance and an unsafe condition.**

## WET BRAKES

Driving through water or washing your car can get the brake components wet.

To restore normal braking:

1. Check behind you for other vehicles.
2. Keep a safe forward speed with plenty of space to your rear and sides.
3. Gently apply brakes until normal performance is restored.

## OVERHEATED BRAKES

Braking excessively when going down a long, steep hill can temporarily overheat the brakes. Shift to a lower gear when going down hills. Do not continuously apply the brakes.

**▲ WARNING**

After driving through deep water, washing the vehicle, or using the brakes excessively when going down a steep hill, the brakes can temporarily lose their stopping power. This may be due to wet brake components or overheating.

If your brakes temporarily lose their stopping power because of overheating:

- Shift to a lower gear when going down hills. Do not continuously apply the brakes.

If your brakes temporarily lose their power because of wet brake components, the following procedure will help restore their normal performance:

1. Check behind you for other vehicles.
2. Keep a safe forward speed with plenty of space to your rear and sides.
3. Gently apply the brakes until normal performance is restored.

**PARKING BRAKE**

The parking brake acts on the rear wheels.

The parking brake lever is located between the front seats.

To set the parking brake, stop the vehicle, press the brake pedal and pull the lever up firmly.

To release the parking brake, press the brake pedal and;

1. Pull the lever up slightly.
2. Push the button on the tip of the lever.
3. Lower the lever while holding the button in.

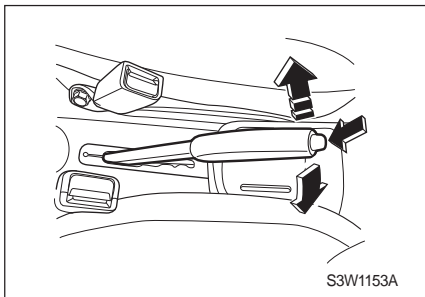
**▲ WARNING**

If the parking brake is not set properly, the vehicle may move suddenly. See your CHEVROLET retailer if an adjustment is required.

**▲ CAUTION**

- Do not drive with the parking brake on.

This can cause your rear brakes to overheat or wear out prematurely. You may have to replace them, and you could damage other parts of your vehicle.

**▲ CAUTION**

- Do not park or operate your vehicle over combustible materials.

They could touch hot exhaust parts under your vehicle and ignite.

## DRIVING TIPS

### ENGINE BRAKING

#### Parking under wet / cold weather

Under cold weather conditions, the parking brake can freeze in the engaged position. This is most likely to happen if the brakes are wet.

If there is a risk that parking brake may freeze after driving through water deep enough to wet brake components or having the vehicle washed:

1. Apply the parking brake only temporarily while you put the gear selector lever in first or reverse gear.
2. Block the rear wheels with wedge blocks.
3. Then release the parking brake.

#### ▲ WARNING

- Do not use parking brake while the vehicle is in motion, or as a substitute for the brake pedal.

Doing so may cause you to lose control of the vehicle, resulting in a collision, property damage and personal injury.

To help use of braking effect of the engine compression when driving on a long downhill:

For manual transaxle, downshift to a lower gear in a sequential order.

#### ▲ WARNING

**Do not downshift your manual transaxle by two or more gear positions at a time.**

**This prevents damage to your transaxle or loss of control and personal injuries.**

#### NOTE

Use of engine compression during long mountainous descents may prolong the life of your brakes.

### PARKING THE VEHICLE

Hold the brake pedal down and firmly apply the parking brake.

For vehicles with a manual transaxle:

1. Parking on level ground, place the gearshift lever in neutral.
2. On a downhill grade, place the gearshift lever in reverse.
3. On an uphill grade, place the gearshift lever in first gear.

#### ▲ WARNING

**To prevent your parked vehicle from moving accidentally, do not leave the front wheels in a straight ahead position when parking on a hill.**

- Turn the wheels away from the road and apply the parking brake if parking facing downhill.
- Turn the wheels towards the road and apply the parking brake if parking facing uphill.

### **SUGGESTIONS FOR MORE ECONOMIC OPERATION**

Fuel economy is dependent largely on your style of driving.

How you drive, where you drive and when you drive affect how many kilometers you can get from a liter of fuel.

To obtain maximum fuel economy:

- Accelerate slowly
- Avoid unnecessary idling.
- Keep the engine properly tuned.
- Do not race the engine.
- Use the air conditioning only when necessary.
- Slow down when driving on rough roads.
- Keep the tires inflated to the recommended pressure.
- Maintain a safe distance from other vehicles to avoid a collision in case of sudden stops. This will also reduce wear on the brake pads and linings.
- Do not carry unnecessary weight.

- Do not rest your foot on the brake pedal while driving.
- Adhere to the vehicle maintenance schedule and specifications in this Manual.

### **HAZARDOUS DRIVING**

When hazardous driving is encountered due to water, snow, ice, mud, sand, or similar conditions:

- Slow down your vehicle and drive cautiously allowing extra distance for braking.
- Avoid sudden manoeuvres when braking, steering or accelerating.
- When braking, press the brake pedal with a light, up-and-down motion until the vehicle is stopped.
- If stuck in snow, mud or sand, use second gear to avoid spinning of front wheels.

## HYDROPLANING

If your vehicle hydroplanes on a wet road, you cannot control your vehicle because there is little or no traction between road and your tires.

Hydroplaning may occur depending on the road conditions, tread and inflation of your tires and the speed of your vehicle. It is very dangerous.

The best way to prevent hydroplaning is to lower the speed of your vehicle and be cautious whenever you feel the road is wet enough.

## DRIVING THROUGH DEEP WATER

When you are about to drive through deep water, you must check the puddle or standing water is not too deep. If you drive too quickly through deep water, water can enter your engine through the air intake causing severe damage.

### ▲ CAUTION

**Before attempting to drive through deep water, always observe the following precautions:**

- **Do not drive through water if the depth is slightly lower than the underbody of your vehicle.**
- **Drive as slow as you can at speed limit less than 10 km/h.**

## ENGINE EXHAUST

Engine exhaust gases contain carbon monoxide (CO) which is colorless and odorless. Prolonged exposure to CO can lead to unconsciousness and death.

Whenever you suspect that exhaust gases are entering the vehicle, immediately take your vehicle to your CHEVROLET retailer.

### ▲ WARNING

**To protect against CO entering the vehicle, inspect the exhaust system and body according to the following recommendations:**

- **At each oil change.**
- **Whenever you notice a change in sound of exhaust system.**
- **If exhaust system, underbody or rear of vehicle is damaged or becomes corroded.**
- **Do not run the engine in confined or closed areas, such as garages. Move vehicle to an open area.**

**(Continued)**



**▲ WARNING**

(Continued)

- **Do not sit in parked vehicle with the engine running for extended periods of time.**
- **When vehicle is stopped in an unconfined area for any amount of time, put your ventilation in fresh air mode to draw outside air inside.**
- **Do not drive with trunk lid or tailgate open. If driving this way is unavoidable, close windows, put your ventilation system in fresh air mode and run the blower at high speed.**

# 6 EMERGENCIES

---

- SPARE TIRE, JACK AND VEHICLE TOOLS ..... 6-2
- HOW TO CHANGE A FLAT TIRE ..... 6-3
- STARTING THE ENGINE WITH JUMPER CABLES .... 6-6
- TOWING THE VEHICLE ..... 6-8
- ROCKING YOUR VEHICLE ..... 6-10
- OVERHEATING ..... 6-11

## SPARE TIRE, JACK AND VEHICLE TOOLS

Your spare tire, jack and tools are secured in the luggage compartment.

### ▲ WARNING

**Always store jack, spare tire, other tools and equipment securely in their proper location.**

- **Do not store jack, spare tire, or other equipment in passenger compartment.**

**In sudden stop or collision, loose equipment can be thrown around inside your vehicle and cause personal injuries.**

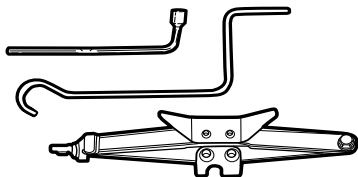

S3W1211A

Secure the spare tire under the floor cover.

Store the jack and the tools in the storage of the luggage compartment. Be sure to secure these tools and equipments, as you found them.

### NOTE

**To eliminate the possibility of the jack, jack handle and tools rattling while the car is moving, secure them properly at the designated place.**

### Jack specification

Maximum Working Load	(600 kg)
Grease Type	Lithium
Grease Class	1 National Lubricating Grease Institute (NLGI)

### ▲ WARNING

**We designed the jack for use on your vehicle only.**

- **Do not use jack provided with your vehicle on other vehicles.**
- **Never exceed the jack's maximum permissible load.**

**Use of this jack on other vehicles may damage the other vehicles or your jack and lead to personal injury.**

## HOW TO CHANGE A FLAT TIRE

If a tire goes flat, observe following safety instruction before you change the tire.

### Tire change safety precautions

1. Turn on the hazard flashers.
2. Pull off the road to a safe place away from traffic.
3. Park on a firm and level surface.
4. Turn off engine and remove key.
5. Set parking brake.
6. Have all passengers get out of vehicle and stand in a safe place.
7. Use a wedge, block of wood, or rocks in front of and behind the tire that is diagonal from the tire you plan to change.

Failure to follow these safety precautions can cause your vehicle to slip off the jack possibly causing serious injury.

### How to change a flat tire

1. Remove the jack, tire changing tools and spare tire from the storage in the luggage compartment.
2. Use the flat head screwdriver to pry off the wheel cover (if so equipped).

If your vehicle is equipped with bolt-on type of wheel covers, loosen 4 plastic caps by a hand with the aid of the wheel wrench and remove the wheel cover.

3. Use the wheel wrench to loosen the wheel nuts or bolts by one turn each.

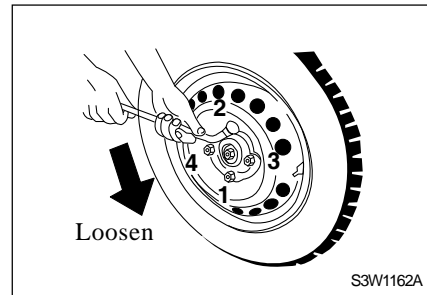

<b>▲ CAUTION</b>
<b>Do not remove any of the nuts or bolts until you have raised the wheel off the ground.</b>

4. Insert the jack handle into the jack.
5. Rotate the jack handle clockwise to raise the lift head slightly.
6. Locate the jack according to the fig. below. There is a notch at the front and rear of the vehicle under the doors.

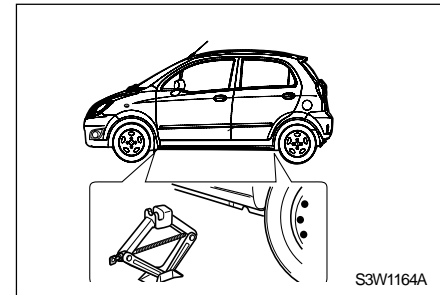

**▲ CAUTION**

**Do not attempt to raise vehicle until the jack is in the proper position, and secure both to the vehicle and the ground.**

7. Place the jack vertically at the front or the rear jacking notch next to the wheel you plan to change.
8. Raise vehicle by rotating jack handle clockwise until lifting head fits firmly into appropriate notch and tire is off the ground about 1 inch (3 cm).

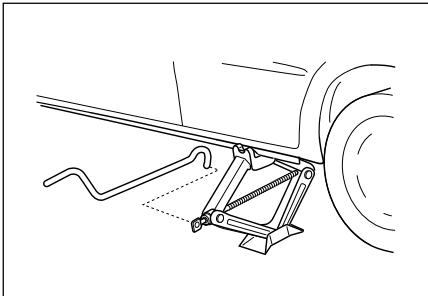

**▲ CAUTION**

- **As the jack begins to raise the vehicle, make sure jack is properly placed so it will not slip.**

**NOTE**

**Do not raise vehicle more than is necessary to change wheel.**

**▲ WARNING**

- **Never get under car or start or run the engine while car is supported by a jack.**

**Vehicle may slip off the jack resulting in serious injury or death.**

9. Remove wheel nuts or bolts completely by turning counterclockwise.
10. Remove tire and wheel.
11. Mount spare tire on the wheel hub.

**▲ CAUTION**

- **Never use oil or grease on studs or nuts. If you do, the nuts might come loose. Your wheel could fall off, causing a serious accident.**
- **Always use correct wheel nuts or bolts.**
- **Using the wheel lug wrench, tighten the lug nuts or bolts down firmly. If tightened incorrectly, the nuts or bolts might come loose.**

12. Replace and lightly seat the wheel nuts or bolts by turning clockwise.
13. Turn jack handle counterclockwise and lower vehicle to the ground.
14. Tighten wheel nuts with the wrench firmly to 100 Nm torque in a “X” pattern; 1→2→3→4 (See fig. below)

**▲ WARNING**

**Make sure to use the proper nuts or bolts tightened to the proper torque.**

**Using incorrect parts or improperly tightened wheel nuts or bolts can cause or come off the vehicle.**

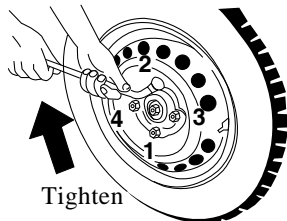

S3W1165A

**▲ CAUTION**

**Improperly tightened wheel nuts can lead to brake pulsation and rotor damage. To avoid expensive brake repairs, evenly tighten the wheel nuts in the proper sequence and to the proper torque specification.**

15. Install wheel cover if required.

When installing the bolt-on type of wheel covers, do the following:

- Put a wheel cover on the tire.
- Fasten 4 plastic caps by a hand snug.
- Tighten them by turning 90° additionally to the maximum 5.9 lb-ft (8 N•m) with the wheel wrench.

**NOTE**

**Have the flat tire fixed for future use as soon as possible.**

16. Secure the jack, tools, and the flat tire in their proper locations.

**▲ CAUTION**

**When using the jack, the vehicle could become unstable and move, damaging the vehicle and causing personal injury.**

- Use jack at correct jacking position.
- When installing the jack for lifting the vehicle, it should be perpendicular to the ground.
- Do not go under a jacked-up vehicle.
- Do not start vehicle while jacked-up.
- Before jacking, get all passengers out of the vehicle and clear of vehicle and other traffic.
- Use jack for changing wheels only.
- Do not jack vehicle on an inclined or slippery surface.
- Use jacking position nearest to the wheel requiring changing.
- Block wheel diagonally opposite the wheel to be changed.

(Continued)

## STARTING THE ENGINE WITH JUMPER CABLES

### ▲ CAUTION

- Before jacking, ensure parking brake is on and the transaxle is set in 1st or reverse gear (M/T).
- Do not jack the vehicle and change the wheel where traffic is close.

### ▲ CAUTION

Call a garage or motoring service for assistance where conditions are not satisfactory for jacking the car or if you are not confident of completing the task safely.

### ▲ CAUTION

- Do not try to start vehicle by pushing or pulling it.
- This can damage catalytic converter and may cause personal injury.

You can start vehicle that has a discharged battery by transferring electrical power to it from a battery in another vehicle.

### ▲ WARNING

Batteries can explode. You could be burned by battery acid and electrical short could injure you or damage the vehicles.

- Do not expose battery to flames or sparks.
- Do not lean over battery while jump starting vehicle.

(Continued)

### ▲ WARNING

- Do not allow cable terminals to touch each other.
- Wear eye protection when working near any battery.
- Do not allow battery fluid to contact eyes, skin, fabric, or painted surfaces.
- Make sure battery providing jump start has the same voltage as the battery receiving the jump.
- Do not disconnect discharged battery from vehicle.

Failure to follow these precautions or the following instructions for starting an engine with jumper cables can cause battery to explode, resulting in burns from battery acid, or electrical short circuit.

This can create damage to electrical systems in both vehicles, and cause serious personal injury.

**Before jump starting**

1. Apply parking brake.
2. For a vehicle with manual transaxle, shift to NEUTRAL.
3. Switch off all electrical accessories.

**▲ CAUTION**

- **Turn audio system off before jump starting your vehicle. Otherwise you may damage audio system.**

**▲ WARNING**

- **Always route jumper cables so they cannot catch on rotating parts in the engine compartment.**

**Otherwise you may damage vehicle and cause serious injury.**

**Attaching jumper cables**

To jump start your vehicle, connect the jumper cables in the following order:

1. Connect one clamp of the first lead of the jumper cable to the positive terminal of the charged battery. (Identified by a “+” sign on the battery case or terminal)
2. Connect the other end of this same jumper cable lead to the positive terminal of the discharged battery. (the “+” terminal)
3. Connect one end of the second lead on jumper cable to the negative terminal of the charged battery. (Identified by a “-” sign on the battery case or terminal)

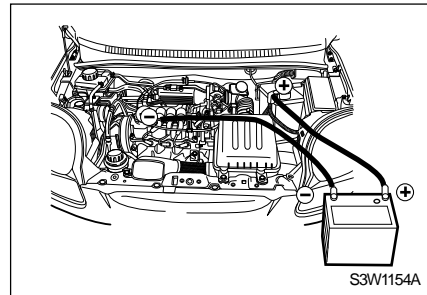

4. Make the last connection to a suitable ground, such as a steel bracket bolted to the engine block.
5. The engine of the vehicle providing the jump start can be allowed to run during the jump start.

**NOTE**

**Attempts to start the engine of the vehicle with the discharged battery should be made at intervals of about one minute and should not last longer than 15 seconds each.**



## TOWING THE VEHICLE

Once the previously discharged vehicle is running:

1. Carefully disconnect the ground connection (-). Begin with the vehicle with the discharged battery. Leave the discharged vehicle running.
2. Disconnect the negative lead from vehicle providing the jump.
3. Disconnect the "+" lead from both batteries.
4. Operate the discharged vehicle for approximately 20 minutes. This will allow the charging system to recharge your battery.
5. If this discharge condition recurs, consult your CHEVROLET retailer.

If it is necessary to tow your vehicle, contact a CHEVROLET retailer or a professional tow truck service.

### ▲ WARNING

- **Never let passengers ride in a vehicle that is being towed.**
- **Never tow a vehicle faster than safe or posted speeds.**
- **Never tow a vehicle with damaged parts that are not fully secured on the vehicle.**

**Failure to observe these precautions can result in personal injury.**

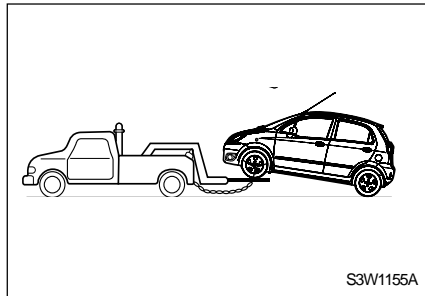

### Towing your vehicle with a wheel lift

1. Turn hazard flashers on.
2. Turn ignition switch to ACC.
3. Shift manual transaxle to NEUTRAL.
4. Release parking brake.

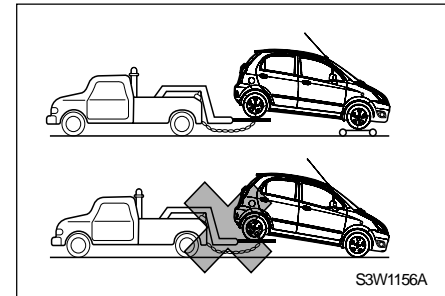

5. Tow the vehicle with the front wheels off the road.

**▲ CAUTION**

- Do not use sling-type equipment to tow the vehicle.
- Use flat bed or wheel lift equipment.

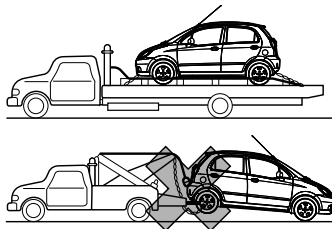

S3W1157A

## EMERGENCY TOWING

If towing service is not available in an emergency, your vehicle may be temporarily towed by a cable secured to one of the emergency towing eyes under the vehicle.

### Front Towing Eyes

The front towing eyes are provided under the front bumper. A driver must be in the vehicle to steer it and operate the brakes.

Towing in this manner may be done only on hard-surfaced road for a short distance and at low speeds.

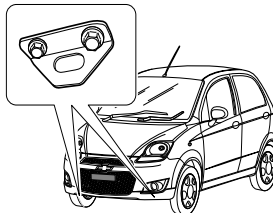

S3W1158A

Also the wheels, axles, drive train, steering and brakes must be all in a good condition.

**▲ CAUTION**

**When towing the vehicle with a tow rope, the vehicle can be damaged.**

**To reduce damage:**

- Use towing eyes only if no other towing equipment is available.
- Only tow the vehicle from the front.
- Keep tow rope clear of bumper.
- Ensure tow rope is securely fixed to towing eyes, at both ends. Check by pulling on tow rope.
- Drive off slowly and avoid jerky movements.

**▲ WARNING**

**When towing with a tow rope, control of towed vehicle can be lost.**

- **Do not tow if the wheels, transaxle, axles, steering or brakes are damaged.**
- **Do not remove the key from the ignition switch as this will lock the steering and this will make the vehicle undriveable.**

**Rear Towing Hook**

When towing another vehicle, use the rear towing hook. It should be used only in an emergency situation. (for example, to pull the vehicle out of a ditch, a snow bank, or mud.).

When the rear towing hook is used, always pull the cable or chain in a straight direction with respect to the hook. Do not apply force to the hook from any side direction. To prevent damage, do not take up slack in the cable too quickly.

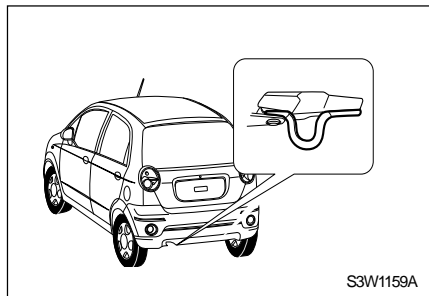
**ROCKING YOUR VEHICLE**

If stuck in snow, mud or other loose surfaces, the procedure below may allow you to free your vehicle.

1. Turn the steering wheel fully left then right. This will clear the area around your front tires.
2. Shift back and forth between R and a forward gear.
3. Spin the wheels as little as possible.
4. Release the accelerator pedal while you shift.
5. Press lightly on the accelerator pedal when the transaxle is in gear.

If that doesn't release your vehicle after a few tries, your vehicle may need to be towed.

**▲ WARNING**

If you rock your vehicle to make it out when it becomes stuck in snow, mud or sand etc.;

- First check that there is no physical object or people around the vehicle.

During operation, the vehicle may suddenly move forward or backward, causing injury or damage to nearby people or objects.

**NOTE**

If you rock your vehicle, observe the following precautions to prevent damage to the transaxle and other parts;

- Do not depress the accelerator pedal while shifting or before the transaxle is completely shifted to forward or reverse.
- Do not race the engine and avoid spinning the wheels.

**OVERHEATING**

If the engine coolant temperature gauge indicates the engine is overheating, or if you have any other reason to suspect the engine may be overheating:

1. Stop the vehicle.
2. Turn off the air conditioning.
3. Let the engine idle for a few minutes.
4. Be sure the cooling fan is operating.

**▲ WARNING**

If steam is visible, move away from vehicle until engine is cool. Steam can cause serious burns.

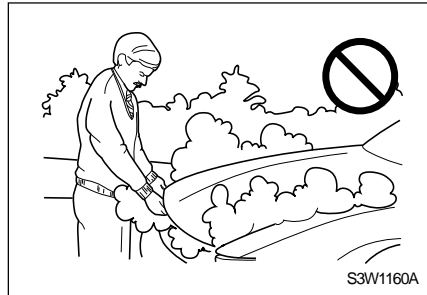
**NOTE**

Using A/C while driving up long hills or in heavy traffic can cause the engine overheating.

If the fan is not operating and steam is visible, perform the following:

1. Turn off engine.
2. Move away from vehicle without opening the hood.
3. Allow engine to cool.
4. When steam is no longer visible, carefully open hood.
5. Consult your CHEVROLET retailer as soon as possible.

If the fan is operating and steam is not visible, perform the following:

1. Carefully open the hood.
2. Idle engine until cool.
3. Check coolant level.

If the fan is operating, but engine temperature does not fall, perform the following:

1. Stop the engine.
2. Carefully open the hood.
3. Allow the engine to cool.
4. Check the coolant level.

If the coolant level is low, check for leaks from following components:

1. Radiator.
2. Radiator hoses.
3. Radiator connections.
4. Heater hoses.
5. Heater hose connections.
6. Water pump.

If you find a leak or other damage, or if the coolant is still leaking, consult CHEVROLET retailer immediately. Do not drive the vehicle until these problems have been solved.

**▲ WARNING**

**Scalding hot coolant steam could be blown out under pressure, which could cause serious injury.**

- **Never remove the coolant reservoir cap when engine and radiator are hot.**

# 7

## SERVICE AND VEHICLE CARE

---

- SAFETY PRECAUTIONS ..... 7-2
- RADIO FREQUENCY IDENTIFICATION (RFID) TAG\* ..... 7-3
- DRIVER'S CHECK LIST ..... 7-3
- ENGINE COMPARTMENT ..... 7-5
- ENGINE OIL ..... 7-6
- COOLANT ..... 7-9
- BRAKE FLUID ..... 7-11
- MANUAL TRANSAXLE FLUID ..... 7-12
- POWER STEERING FLUID (Option) ..... 7-14
- WINDSHIELD WASHER FLUID ..... 7-15
- AIR CLEANER ..... 7-17
- SPARK PLUGS ..... 7-18
- DRIVE BELT ..... 7-19
- BATTERY ..... 7-20
- BRAKE PEDAL ..... 7-22
- CLUTCH PEDAL ..... 7-23
- CATALYTIC CONVERTER ..... 7-23
- WHEELS AND TIRES ..... 7-24
- FUSES AND CIRCUIT BREAKERS ..... 7-27
- BULB REPLACEMENT ..... 7-30
- VEHICLE CARE ..... 7-34

## SAFETY PRECAUTIONS

When performing any inspection or maintenance work on your vehicle, take precautions to reduce the risk of personal injury or damage.

General precautions to observe when performing vehicle service:

- Do not work on the engine while it is hot.

### ▲ WARNING

**The catalytic converter and other exhaust components while engine is running can get very hot.**

**Touching the related parts while engine is running can result in severe burns.**

- Never get under the vehicle while it is supported by a jack. If it is necessary to work under the vehicle, use safety stands.
- Keep smoking materials, flames, and sparks away from the battery, all fuel, and fuel-related parts.

- **Never connect or disconnect the battery or any transistorized components while the ignition switch is ON.**
- When connecting the battery cables, pay special attention to their polarities. Never connect a positive cable to a negative terminal, or a negative cable to a positive terminal.
- Remember that the battery, ignition cables, and your vehicle wiring carry high current or voltage. Be careful not to cause a short circuit.
- Make sure there is proper ventilation whenever you have the engine running in an enclosed space such as a garage.
- Keep used oil, coolant, and other fluids out of reach of children and pets.
- Do not dispose of empty oil and fluid containers, or those containing used oil or fluid, with your household waste. Use only locally authorized automotive waste disposal facilities.
- If it is necessary to check under the hood while the engine is running, take care to avoid unexpected and sudden movements of your vehicle. For a manual transaxle, place the shift lever in neutral and apply the parking brake firmly.
- To avoid the possibility of personal injury, always turn the ignition OFF and remove the key before working under the hood, unless the procedure specifically requires to do so. If the procedure requires you to work under the hood while the engine is running, remove loose clothing and jewelry that can be caught in moving parts and cause personal injury.

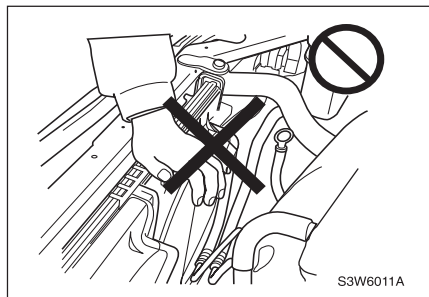

**Engine compartment cooling fan****▲ CAUTION**

**The electric cooling fans (in the engine compartment) are controlled by sensors. These fans may come on at any time.**

- **It is important to keep hands, fingers, and any loose articles clear of the fan blades.**

To avoid possible injury from the cooling fan, switch off the engine so the fan is not operating before you perform any engine checks.

Also, be aware that the electronic ignition system has a higher voltage than conventional systems. Therefore, it is highly dangerous to touch live parts when your vehicle's ignition is ON.

**RADIO FREQUENCY IDENTIFICATION (RFID) TAG \***

This vehicle is equipped with Radio Frequency Identification (RFID) tag\*, which can be used for Electronic Toll Collection (ETC) or any other applications as decided by the Regulatory authority. The RFID tag is located on inside the windshield. Data for necessary applications will be added by the agency authorized by the Regulatory authority, from time to time. Take proper care during washing or cleaning of windshield so as to avoid any damage to the RFID tag. In case of any damage or malfunction of RFID tag, or in case of windshield replacement, contact your CHEVROLET retailer or agency authorized by the Regulatory authority for the installation of new RFID tag.

**▲ CAUTION**

**Do not touch or peel off. Do not place any sticker or other metallic components over the RFID tag neither from inside nor from outside of the windshield. Avoid exposure to chemicals or liquid solvents. This will impair the function of RFID tag. The RFID tag is tamperproof and will not function once removed from windshield.**

**DRIVER'S CHECK LIST**

To maintain safe and dependable operation of your vehicle, periodically check the exterior, interior, and engine compartment.

**EXTERIOR****Tires**

- Properly inflated.
- No cracks on sidewall or tread.
- No foreign objects in tread.

**Wheels**

- Nuts and bolts are torqued to proper setting. (See "HOW TO CHANGE A FLAT TIRE" on page 6-3).

**Lamps**

- Operation of all running, head, tail, side markers, turn signals, brake and fog lamps.

**Fluids**

- Check proper fill level of all fluid reservoirs under hood.

**Windshield wipers**

- Inspect condition of arms and rubber inserts.



## **INTERIOR**

### **Steering**

- Check for excessive looseness (free play) in steering wheel.

### **Parking brake**

- Make sure parking brake lever travel is appropriate.

### **Instrument panel**

- Check proper operations of all instrument panel gauges, controls, and warning lamps.

### **Mirrors**

- Be sure the reflective surface of all three mirrors is in good condition and clean.
- Check for ability to easily re-adjust all mirrors.

### **Controls**

- Check for proper play on brake and clutch pedals.

## ENGINE COMPARTMENT

### 1.0 SOHC MODEL

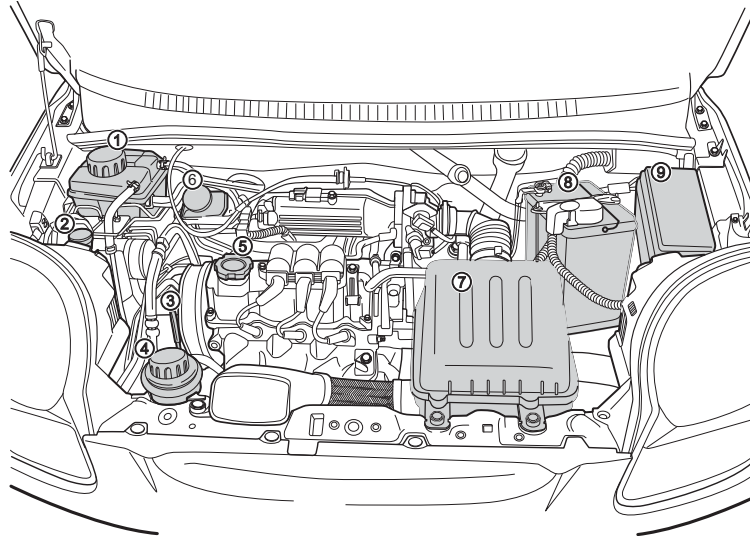

S3W1166A

1. Engine Coolant Reservoir
2. Washer Fluid Reservoir
3. Engine Oil Dipstick

4. Power Steering Fluid Reservoir\*
5. Oil Fill Cap
6. Brake Fluid Reservoir

7. Air Cleaner
8. Battery
9. Underhood Fuse and Relay Center

## ENGINE OIL

Keep your engine properly lubricated by keeping the engine oil at the proper level.

It is normal for an engine to consume some engine oil.

Check the oil level at regular intervals.

If the engine oil pressure warning lamp (🚗) on the instrument panel comes on, you need to check your engine oil level right away.

### CHECKING ENGINE OIL LEVEL

1. Park vehicle on level ground.
2. After stopping engine, wait a few minutes to allow oil to drain back into oil pan. If engine is cold, oil will take longer to drain into the pan.
3. Pull out the dipstick and wipe it clean.
4. Re-insert dipstick completely.
5. Pull the dipstick out again.
6. Check the oil on the dipstick to make sure it is not contaminated.
7. Check oil level, as shown on the dipstick. Oil should be between MIN and MAX.

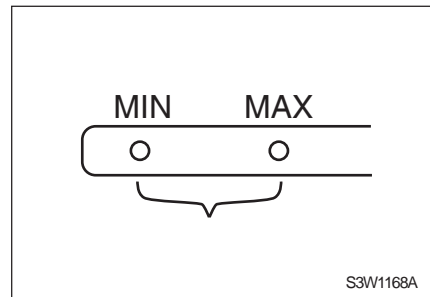
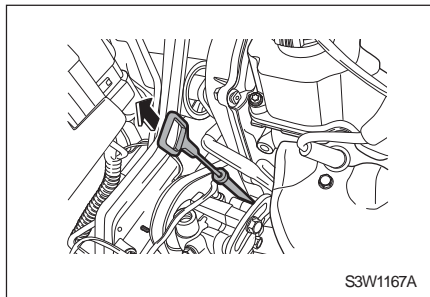

8. If the oil level is below MIN, add enough oil of the same grade as is currently in the engine to raise the oil level to MAX. Do not fill over MAX mark.

The engine oil filler cap is located on the cylinder head cover as shown in the illustration below.

See “FLUID CHART” on page 9-3 for oil specification.

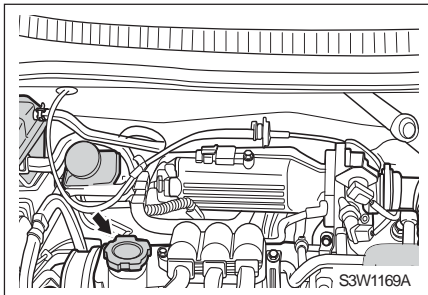

**▲ WARNING**

**Engine oil is an irritant and, if ingested, can cause illness or death.**

- **Keep out of reach of children.**
- **Avoid repeated or prolonged contact with skin.**
- **Wash exposed areas with soap and water or hand cleaner.**

**▲ WARNING**

**Adding too much oil can affect engine operation.**

- **Do not allow oil to go above MAX mark on dipstick.**

**Overfilling can damage your vehicle by:**

- **Increasing oil consumption.**
- **Fouling spark plugs.**
- **Building excessive carbon deposits in the engine.**

### CHANGING ENGINE OIL AND FILTER

Engine oil loses its ability to lubricate when contaminated. Be sure to change your engine oil according to maintenance schedule.

Be sure to replace the engine oil filter each time you change engine oil.

Under severe conditions, change oil and oil filter more frequently than is recommended in the standard maintenance schedule.

Severe conditions include, but are not limited to:

- Frequent cold starts.
- Considerable travel in stop-and-go traffic.
- Frequent short trips.
- Frequent driving when outside temperature remains below freezing.
- Prolonged idling.
- Frequent low-speed driving.
- Driving in dusty areas.

**▲ WARNING**

**Engine oil and its containers can be hazardous to your health.**

- **Avoid repeated or prolonged contact with engine oil.**
- **Clean your skin and nails with soap and water, or hand cleaner after handling engine oil. Also keep this and other toxic materials out of the reach of children.**

**Engine oil can irritate the skin and can cause illness and even death if swallowed.**

**▲ CAUTION**

**Use of unauthorized or low quality engine oil or chemical engine treatments (additives) can damage the engine.**

- **Consult your CHEVROLET retailer before attempting to use additives.**

**▲ CAUTION**

- **Do not dispose of used engine oil and filter with your household waste.**
- **Use your local, authorized waste management facility.**

**Used engine oil and filter contain harmful elements that may be unhealthy to you and threat to the environment.**

## COOLANT

### RECOMMENDED ENGINE OIL AND MAINTENANCE SCHEDULE

#### Recommended engine oil

See “FLUID CHART” on page 9-3. For recommended engine oil and capacity.

#### Maintenance schedule

See “SCHEDULED MAINTENANCE SERVICES” on page 8-4.

Your vehicle cooling system is filled with silicate based coolant.

In the correct mixture, this coolant provides the cooling and heating system with excellent protection against corrosion and freezing.

When the engine is cool, the coolant level should be between the MIN and MAX mark on the coolant reservoir. The level of coolant rises as the engine warms and drops back as the engine cools.

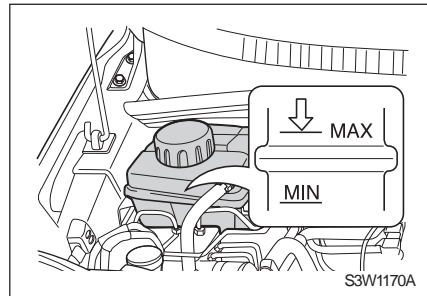

### CAUTION

**Plain water or the wrong mixture can damage the cooling system.**

- **Do not use plain water, alcohol or methanol antifreeze in coolant system.**

**The engine may overheat or even catch fire.**

If the coolant level falls below the MIN mark, add the proper coolant mixture at the coolant reservoir, but only when the engine is cool.

In order to protect your vehicle in extremely cold weather, use GMI approved coolant.

 **WARNING**

Scalding hot coolant and steam could be blown out under pressure, which could cause serious injury.

- Never remove the coolant reservoir cap when the engine and radiator are hot.

 **CAUTION**

Coolant can be hazardous material.

- Avoid repeated or prolonged contact with coolant.
- Clean your skin and nails with soap and water after coming in contact with coolant.
- Keep out of reach of children.
- Coolant can irritate the skin and can cause illness or death if swallowed.

**COOLANT SPECIFICATION AND MAINTENANCE SCHEDULE**

**Coolant specification**

See “FLUID CHART” on page 9-3. For recommended coolant and capacity.

**Maintenance schedule**

See “SCHEDULED MAINTENANCE SERVICES” on page 8-4.

 **CAUTION**

It is not needed to add coolant more frequently than the recommended interval. If you are adding coolant often, this may be a sign that your engine needs maintenance.

Contact your CHEVROLET retailer for a check of the cooling system.

## BRAKE FLUID

Brake fluid can absorb moisture. Excessive moisture in the fluid may reduce the effectiveness of the hydraulic brake system. Change the fluid according to this Manual to prevent hydraulic system corrosion.

Use only recommended Brake fluid. Keep reservoir filled to the proper level. Do not allow the level to fall below MIN mark or to rise beyond the MAX mark.

A low fluid level in the brake fluid reservoir can be either an indication of a leak in the brake system or a normal indication caused by usual brake pad/lining wear. Consult your CHEVROLET retailer to determine if the system needs repair and add fluid after work is done on your hydraulic brake system if it is required.

When your brake fluid drops to low level, the brake system warning lamp (ⓄⓄ) will come on.

### ADDING BRAKE FLUID

1. Thoroughly wipe away dirt from around the fluid reservoir cap.

#### ▲ CAUTION

- **Make sure you thoroughly clean around the brake fluid reservoir cap before removing the cap.**

**Contamination of the brake fluid can affect system performance, leading to costly repairs.**

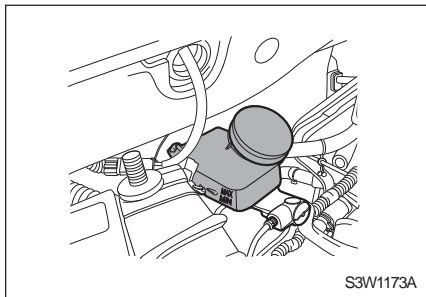

2. Unscrew the filler cap.
3. Use the proper recommended brake fluid to fill the reservoir to the MAX mark. Be careful not to spill the fluid on painted surfaces. If this happens, use cold water to wash the affected area immediately.
4. Reinstall the reservoir cap.

#### ▲ CAUTION

**An overflow of brake fluid on the engine may cause the fluid to burn.**

- **Do not overfill the reservoir.**

**An engine fire can cause personal injuries and damage your vehicle and other property.**



**▲ CAUTION**

- Do not dispose of used brake fluid with your household waste.
- Use your local, authorized waste management facility.

Used brake fluid and their containers are hazardous. They can damage your health and the environment.

**▲ CAUTION**

Brake fluid is harsh and can irritate skin and eyes.

- Do not allow the brake fluid to contact your skin or eyes. If it does, immediately wash the affected area thoroughly with soap and water, or hand cleaner.

**RECOMMENDED BRAKE FLUID AND MAINTENANCE SCHEDULE**

**Recommended brake fluid**

See “FLUID CHART” on page 9-3. For recommended brake fluid and capacity.

**Maintenance schedule**

See “SCHEDULED MAINTENANCE SERVICES” on page 8-4.

**MANUAL TRANSAXLE FLUID CHECKING MANUAL TRANSAXLE FLUID LEVEL**

**▲ WARNING**

**This work requires special skill and equipments to be completed.**

**Before attempting to do the work, be sure you are fully acquainted with doing this job.**

- Have your CHEVROLET retailer do this work if you are not confident of completing the task safely.

**Otherwise, you could be injured or damage the vehicle.**

1. Turn the engine off.
2. Allow the transaxle to cool. It must be cool enough for you to rest your fingers on the transaxle case.

**▲ CAUTION**

**Heat from engine, transaxle or fluid can cause severe burns.**

- **Make sure the transaxle is cool to the touch before you attempt this procedure.**

**Working on the engine before it has cooled properly can result in personal injuries.**

3. Remove filler plug.
4. Make sure the fluid reaches the bottom edge of the filler plug hole.

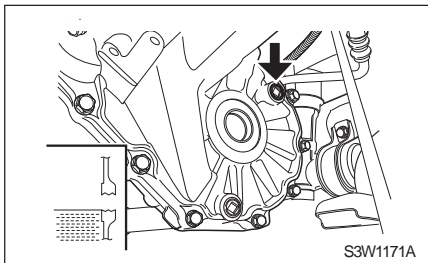

5. If the level is low, add fluid until it begins to run out the filler hole.
6. After filling to the correct level, reinstall the plug securely.

**▲ CAUTION**

**Too much fluid will decrease vehicle performance.**

- **Do not overfill the manual transaxle fluid.**

**This can damage the transaxle.**

7. Visually check the transaxle case for leaks or damage.

## RECOMMENDED MANUAL TRANSAXLE FLUID AND MAINTENANCE SCHEDULE

### Recommended manual transaxle fluid

See “FLUID CHART” on page 9-3. For recommended manual transaxle fluid and capacity.

### Maintenance schedule

See “SCHEDULED MAINTENANCE SERVICES” on page 8-4.

## POWER STEERING FLUID (Option)

### CHECKING POWER STEERING FLUID LEVEL

Regularly check power steering fluid level.

The power steering fluid reservoir is located in front/right of the engine compartment.

#### ▲ CAUTION

- **Do not operate vehicle without the required amount of power steering fluid.**

**Doing so can damage power steering system of your vehicle, leading to costly repairs.**

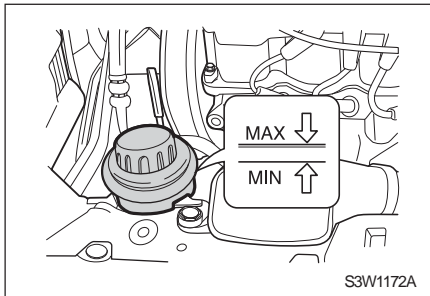

1. Turn the engine off.
2. Check the fluid level. It should be between MIN and MAX on the reservoir.

If level drops to or below MIN, add fluid as specified in this Manual.

### ADDING POWER STEERING FLUID

1. Wipe the cap and the top of the reservoir clean.
2. Unscrew the cap.
3. Add the power steering fluid. Be sure to maintain the level between MIN and MAX mark.
4. Replace the cap.

#### ▲ CAUTION

**An overflow of the fluid may cause the fluid to burn or discolor paintwork.**

- **Do not overfill the reservoir.**

**An engine fire can cause personal injuries and damage your vehicle and other property.**

## WINDSHIELD WASHER FLUID

### RECOMMENDED POWER STEERING FLUID AND MAINTENANCE SCHEDULE

#### Recommended power steering fluid

See “FLUID CHART” on page 9-3. For recommended power steering fluid and capacity.

#### Maintenance schedule

See “SCHEDULED MAINTENANCE SERVICES” on page 8-4.

Before you drive, make sure the windshield washer fluid reservoir is at the appropriate level and filled with the correct solution.

In cold weather, do not fill the windshield washer fluid reservoir more than three quarters full.

Washer fluid can freeze to expand in cold temperatures. Filling the reservoir too much does not allow enough expansion room to prevent possible damage to the reservoir.

#### NOTE

To refill windshield washer fluid reservoir:

- Use only commercially available ready-to-use washer fluid for that purpose.
- Do not use tap water. Minerals present in tap water may plug the windshield washer lines.

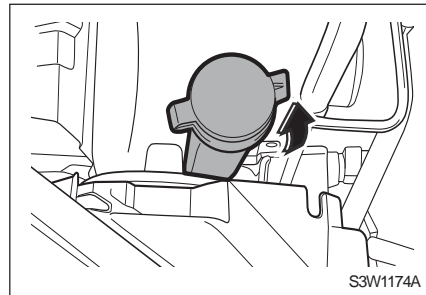

## WIPER BLADES

Check the condition of the wiper blades regularly.

If the wiper blades are not wiping properly, clean the windshield glass and the blades with a mild detergent and rinse with water.

### NOTE

**Do not use any of the following as a cleaner:**

- Solvents
- Gasoline
- Kerosene
- Paint thinner
- Silicone-based polish

**Otherwise, the vehicle could be damaged.**

### NOTE

**Do not use a silicone-based polish on the windshield glass. Silicone will permanently streak the glass.**

### ▲ CAUTION

**Less than clear vision for the driver can lead to an accident resulting in personal injury and damage to your vehicle or other property.**

Wiper blades will eventually wear out and not wipe properly, reducing forward vision.

Replacement is necessary if:

- The wiper blade is hard, brittle or cracked.
- The wiper blade no longer effectively clears the windshield.

To replace a wiper blade, do the following:

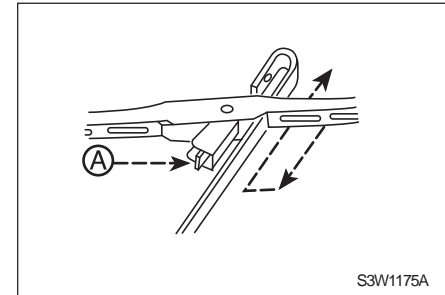

1. Press and hold the retaining clip (A).
2. Take the worn wiper blade off the wiper arm.
3. Install a new wiper blade onto the wiper arm.

## AIR CLEANER

Regularly inspect and change the air cleaner element according to the service schedule in this Manual.

### ▲ CAUTION

The engine needs clean air to operate properly.

- Do not operate your vehicle without the air cleaner element installed.

Driving without the air cleaner element properly installed can damage your engine.

### CLEANING THE AIR CLEANER

If the air cleaner element is dirty, you may try to clean it as follows:

1. Open the hood and remove the cover (A).

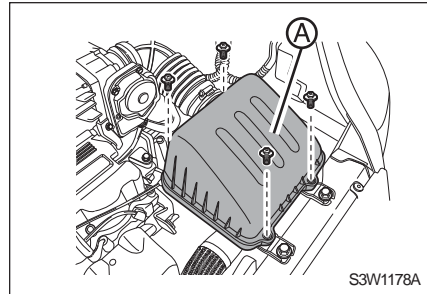

2. Remove the filter. Take care to dislodge as little dirt as possible.
3. Clean the inside of the housing.
4. Cover the housing with a damp cloth while cleaning the filter.
5. Away from the vehicle's engine compartment, lightly shake the filter to release loose dust and dirt.

6. Clean the filter by blowing compressed air through it in direction (A) opposite of normal airflow (B).

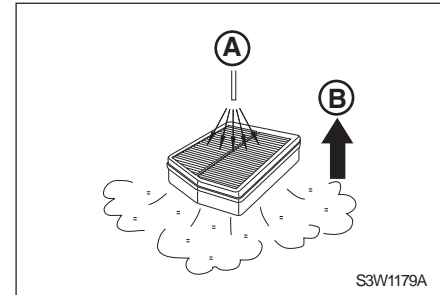

7. Change the filter if it remains choked with dirt.

Reinstall the cover when you are done.

### MAINTENANCE SCHEDULE

See "SCHEDULED MAINTENANCE SERVICES" on page 8-4.

## SPARK PLUGS

### IGNITION SYSTEM

#### ▲ WARNING

Electric ignition systems have greater voltage than conventional systems.

- Do not touch components of ignition system. Touching ignition system components could cause shock or electrocution, resulting in serious injuries.

If you experience reduced performance or fuel economy, follow the procedure to inspect and clean spark plugs.

#### ▲ CAUTION

Spark plugs can become extremely hot and could cause serious injury.

- Do not handle hot spark plugs.

### INSPECTING AND REPLACING SPARK PLUGS

1. Once the engine has cooled to the touch, disconnect the spark plug wire by pulling on the boot, not the cable.
2. Use a 21 mm spark plug socket and remove the spark plugs from the engine. Be sure contaminants not to enter the spark plug hole.
3. Inspect the spark plugs for broken insulator. Replace the plug if the insulator is cracked or broken. Otherwise, wipe the insulator clean.
4. Using a very fine wire brush, clean the upper contact tip and electrode. After cleaning, adjust the gap to the specification.

See “VEHICLE SPECIFICATIONS” on page 9-6 for the spark plug specification.

5. Install each spark plug by hand as far as it will go.

#### NOTE

When replacing new spark plugs, the entire set should be replaced at a time.

6. Torque each spark plug.
7. Fasten the spark plug wire terminal squarely and firmly over the end of each spark plug until you feel it snap into place. Make sure the spark plug wires are in the correct order.

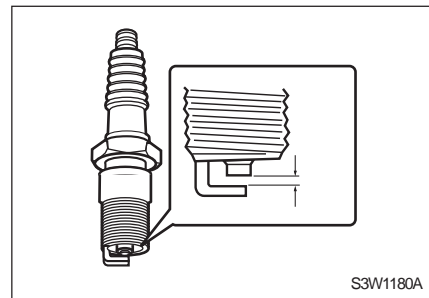

S3W1180A

**▲ CAUTION**

- **Over-tightened spark plugs can damage the threads in the cylinder head.**
- **Under-tightened spark plugs can cause the spark plug to become very hot.**

**Over-tightening or under-tightening of spark plugs can damage the engine.**

**SPARK PLUG SPECIFICATION AND MAINTENANCE SCHEDULE****Spark plug specification**

See “VEHICLE SPECIFICATIONS” on page 9-6 for the type and the gap of the spark plugs.

**Maintenance schedule**

See “SCHEDULED MAINTENANCE SERVICES” on page 8-4.

**DRIVE BELT**

In order for the generator, power steering pump and air conditioning compressor to function properly, the drive belt should be in good condition and should be adjusted properly.

Replace the drive belt if it is worn, cracked, or frayed.

**▲ CAUTION**

**Do not leave the key in the ignition while checking the drive belt.**

**Otherwise, the engine could be started unexpectedly.**

**Fans or other moving engine parts can injure you badly.**



## BATTERY

To check the drive belt tension, do the following:

1. Apply moderate thumb pressure (approximately 10 kgf) midway along the longest, unsupported span of the drive belt.

The deflection of the drive belt (caused by your thumb pressure) should be about 10 mm.

2. If the belt is too loose, see your CHEVROLET retailer for service.

See the Maintenance Schedule for more information.

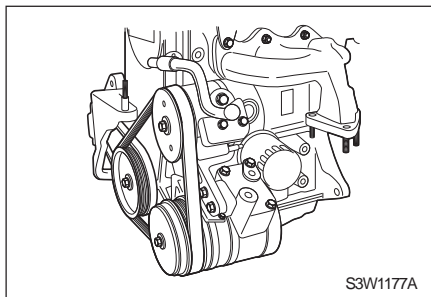

Your vehicle is equipped with a maintenance-free battery.

### ▲ WARNING

**Battery acid can cause severe burns, explode, and damage paint.**

- **Avoid skin and clothing contact with battery acid.**
- **Keep flames, sparks and smoking materials away from battery.**

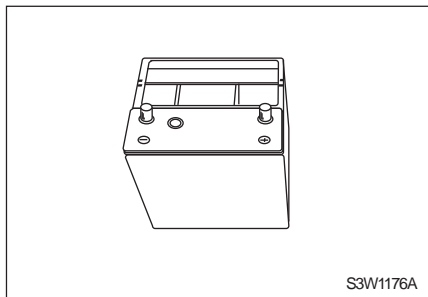

## CLEANING THE BATTERY TERMINALS

1. Turn the ignition OFF and remove the key from the ignition key slot.
2. Use a wrench to loosen and remove the battery cable clamps from the terminals. Always disconnect the negative (-) terminal first.
3. Use a wire brush or a terminal cleaning tool to clean the terminals.
4. Check the battery terminals for white or bluish powder, which are signs of corrosion.
5. Remove any corrosion with a solution of baking soda and water. The baking soda-and-water solution will bubble and turn brown.
6. When the bubbling stops, wash the solution off with plain water and dry the battery with a cloth or paper towel.
7. Reconnect and tighten the positive (+) terminal, then the negative (-) terminal. Always reconnect the negative terminal (-) last.

**▲ CAUTION**

- **When reconnecting the cable to the battery, be careful to ensure the clamps are fully seated, then tighten the retaining bolts so the clamps will not vibrate loose.**
- **Be sure to attach the red cable to the positive (+) battery terminal and the black cable to the negative (-) battery terminal.**

**Connecting the vehicle's battery cables to the wrong terminals can result in personal injuries and damage to your vehicle and other property.**

8. Coat the terminals with petroleum jelly or terminal grease to help prevent future corrosion.

**BATTERY MAINTENANCE**

To extend the life of your vehicle's battery, be sure to do the following:

- Keep the battery mounted securely.
- Keep the top of the battery clean and dry.
- Keep the terminals and connections clean, tight and coated with petroleum jelly or terminal grease.
- Immediately rinse off any spilled electrolyte using a solution of water and baking soda.
- If your vehicle will not be used for an extended time, disconnect the cable from the negative (-) terminal.
- Charge a disconnected battery every six weeks.

**NOTE**

**Batteries contain toxic material. Used batteries can be hazardous to health and environment.**

- **Do not dispose of battery with household waste. Use locally authorized automotive waste disposal facilities only.**

## BRAKE PEDAL

### BRAKE PEDAL FREE PLAY

Brake pedal free play must be 6-10 mm.

To check the brake pedal free play, turn the engine off and press the brake pedal several times to deplete the vacuum in the brake system.

Then, when you press the brake pedal by hand, measure the distance the pedal moves until there is a slight resistance.

See your CHEVROLET retailer, if the brake pedal free play differs from the norm. The brakes need to be adjusted.

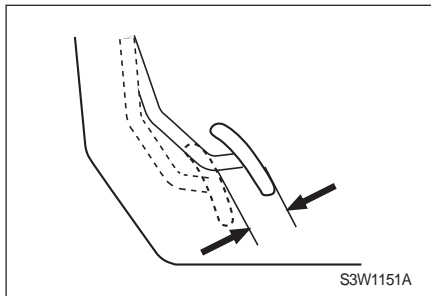

### PARKING BRAKE LEVER TRAVEL

The parking brake lever travel must be 5-7 notches, with a force of approximately 20 kgf.

To check the parking brake lever travel, turn the engine off. Apply the parking brake and count the notch clicks.

See your CHEVROLET retailer, if the parking brake travel differs from the norm. The parking brake needs to be adjusted.

#### ▲ CAUTION

**If the parking brake is not set properly, the vehicle may move suddenly and/or cause an accident. See a CHEVROLET retailer for service if brake adjustment is required.**

#### ▲ CAUTION

**Do not use the parking brake while the vehicle is in motion, or as a substitute for the brake pedal.**

**You could lose control of the vehicle and you or others may be injured.**

#### NOTE

**Do not drive with the parking brake set.**

**Driving with the parking brake on can cause the rear brakes to overheat.**

**The rear brakes, and even other parts of the vehicle, may be damaged. Always check that the parking brake is fully released before you begin to drive. Make sure the brake system warning light is off.**

## CLUTCH PEDAL

### CHECKING CLUTCH PEDAL FREE PLAY

Clutch pedal free play must be: **0 mm**

To check the clutch pedal free play, do the following:

1. Turn engine off.
2. Press clutch pedal by hand measuring distance the pedal moves until you feel resistance.
3. If free play differs from that specified above, have your CHEVROLET retailer, adjust the clutch pedal or linkage.

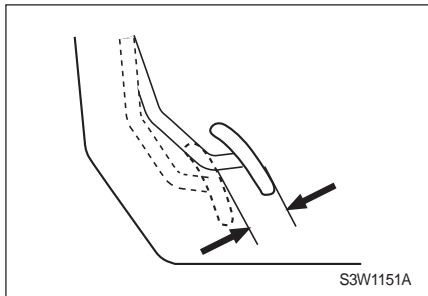

## CATALYTIC CONVERTER

### ▲ CAUTION

Your vehicle is equipped with a catalytic converter.

- **Do not use leaded fuel in this vehicle.**

On vehicles with a catalytic converter, the fuel tank has a narrow filler neck which makes it impossible to insert a nozzle for leaded fuel.

### ▲ CAUTION

**The catalytic converter can be damaged by imperfect combustion if you keep starting the engine with the accelerator pedal pressed when having difficulty in starting the engine.**

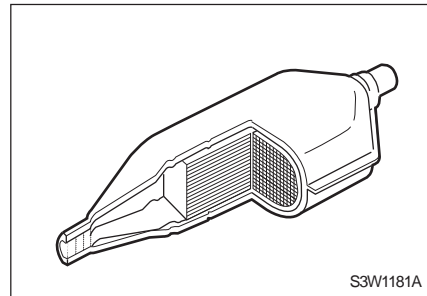

### ▲ CAUTION

- **Do not drive your vehicle if the engine is running roughly or lacks power. These symptoms can point to serious mechanical problems.**

**Operating your vehicle under these conditions can cause serious damage to the catalytic converter and other parts of the vehicle.**

Consult your CHEVROLET retailer as soon as possible if any of the following occur:

- Engine misfires.
- Engine runs rough following a cold start.
- Engine loses power.
- Vehicle exhibits unusual operating conditions which may indicate a fault in the ignition system.

**▲ CAUTION**

- **Avoid frequent repeated cold starts.**
- **Do not hold the key in START for more than 15 seconds while trying to start your vehicle.**
- **Do not let the fuel tank run dry.**
- **Do not start the engine by pushing or towing your vehicle. Use jump starting.**

**Failure to follow these instructions may damage your vehicle engine, fuel, and/or emission systems.**

Make sure to have all your vehicle maintenance done by a CHEVROLET retailer.

This will insure that:

- All vehicle components operate correctly.
- Your vehicle will have minimal exhaust emissions.
- Your vehicle's catalytic converter system will have a long life.

**WHEELS AND TIRES**

Factory-fitted tires are matched to your vehicle, offering the most effective combination of ride comfort, tread life and performance.

**▲ CAUTION**

**Use of unsuitable tires and/or wheels may lead to a collision.**

- **Consult your CHEVROLET retailer before you change your original tires or wheels.**

**This can result in personal injuries and damage to your vehicle or other property.**

**MAINTENANCE****▲ WARNING**

- **Never overload your vehicle.**
- **Always drive with properly inflated tires.**
- **Always check tire inflation pressure when the tires are cold (ambient temperature).**

Maintaining tires at pressure specified in this Manual will ensure the most effective combination of driving comfort, safety and performance.

Use an accurate tire pressure gauge to check the pressure of tires when they are cold. Securely retighten the valve caps after checking tire inflation pressure.

**NOTE**

**Check inflation pressure when tires are cold. Warm tires produce inaccurate readings. Tires become warm after you have driven more than 1.5 kms and stay warm for three hours after vehicle has been stopped.**



S3W6401A

See “VEHICLE SPECIFICATIONS” on page 9-6 for proper tire inflation pressure.

Tire condition should be inspected before driving and tire pressure should be checked each time you fill your fuel tank or at least once a month using a tire pressure gauge.

Incorrect tire inflation pressures will:

- Increase tire wear.
- Impair vehicle handling and safe operation.
- Affect ride comfort.
- Reduce fuel economy.

**If tire pressure is too low, tires can overheat and suffer internal damage, tread separation, and even a blowout at high speeds. Even if you later adjust the inflation pressure of your tires, previous driving with low pressure may have damaged the tires.**

### Caring for your tires and wheels

Driving over sharp objects can damage the tires and wheels. If some objects are unavoidable, drive over them slowly and at a right angle, if possible.

When parking, avoid making contact with the curb.

### Periodic tire inspection

- Visual damage.
- Foreign objects
- Punctures.
- Cuts.
- Cracks.
- Bulges in the sidewalls.

Check the wheels for damage.

Tire defects including those above can cause loss of control of your vehicle, resulting in a possible collision.

If your tires or wheels are damaged or show abnormal wear, consult your CHEVROLET retailer.

### ▲ CAUTION

**Use of tires of a size other than originally fitted to your vehicle may cause interference between tires and vehicle components, and may result in tire and vehicle damage.**

### BUILT-IN TREAD WEAR INDICATOR

Regularly check the tread depth of your tires using the tire’s built-in tread wear indicators. Markings on the sidewalls indicate the locations of the tread wear indicators.

### ▲ CAUTION

- **Do not drive on worn or damaged tires. Such tires can cause you to lose control of the vehicle and a collision, resulting in injuries or damage to your vehicle or other property.**

Replace tires when the tread wear indicators become visible. The wear indicators appear between the tread grooves when the tread depth is 1.6 mm (0.06 in) or less.

**NOTE**

**Always dispose of worn tires according to local environmental regulation.**

**TIRE ROTATION**

Front and rear tires perform different jobs and can wear differently.

Normally, the front tires will wear faster than rear tires. To prolong the life of your tires and avoid uneven tread wear:

1. Rotate tires every 7,500 kms.
2. Maintain proper tire pressure.
3. Check tightening of the lug nuts/bolts.

See “HOW TO CHANGE A FLAT TIRE” on page 6-3.

**▲ WARNING**

- **Use the recommended wheels and wheel lug nuts/bolts only.**
- Otherwise, you can lose control of your vehicle and cause a collision that can result in injuries or damage to your vehicle or other property.**

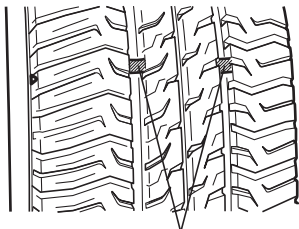

Tread wear indicator S3W6411A

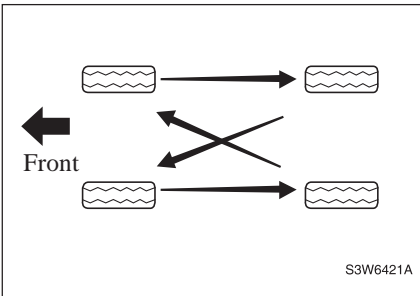

S3W6421A

## FUSES AND CIRCUIT BREAKERS

The wiring circuits in your vehicle are protected from short circuits by a combination of fuses, circuit breakers and fusible thermal links. This greatly reduces the chance of fires caused by electrical problems.

The fuse block is on the lower driver's side of the instrument panel.

- To remove the fuse block cover, press the tabs on the cover, then lift the cover off.
- To reinstall the cover, press it back into place.

Additional fuses are located in the engine compartment.

The engine compartment fuse block is located next to the battery.

- To remove the fuse block cover, press the tab at the bottom of the cover, then lift the cover off.
- To reinstall the cover, first insert the two tabs at the top, and then press it back into place.

Spare fuses and a fuse extractor are located in the engine compartment fuse block.

Identify a defective fuse by its melted wire.

Look at the silver-colored band inside the fuse. If the band is broken or melted (A), replace the fuse. Be sure you replace a bad fuse with a new one of the correct size.

Use a fuse extractor to remove the blown fuse.

If a fuse is blown, try to determine and repair the cause of the problem.

Be sure you replace a bad fuse with a new one of the correct size and rating.

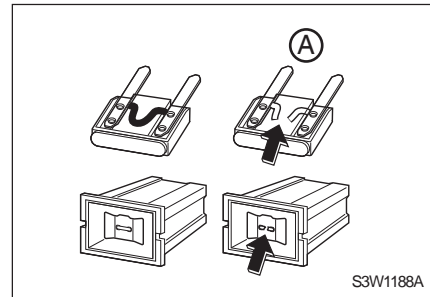
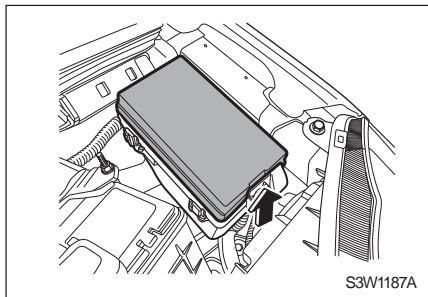
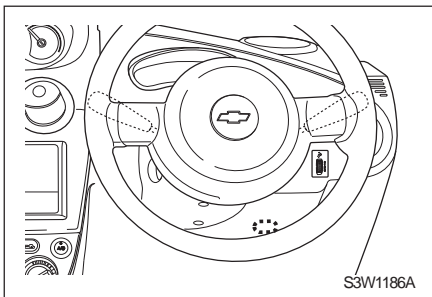



**▲ CAUTION**

**Do not use a tool that can conduct electricity when removing a blown fuse. Only use the provided fuse extractor. Using a conductor such as metal can cause a short circuit, damage the electrical system or start a fire. Serious injury could occur.**

**▲ CAUTION**

**Using a fuse substitute or a fuse of the wrong type or rating can damage the electrical system or even start a fire. Be sure you replace a bad fuse with a new one of the correct size and rating. Otherwise, you could be injured or your vehicle could be damaged.**

**INSTRUMENT PANEL FUSE BLOCK**

1. Daytime Running Lights\*
2. Indicator/Warning Lights Display
3. Room Light
4. Door Lock
5. Stoplight
6. Rear Wiper\*
7. Front Wiper
8. Backup Light
9. Blower Motor
10. Cluster
11. Air Bag\*
12. Power Window
13. Turn Signal
14. Engine Management System
15. Blank
16. Blank
17. Cigarette Lighter
18. Audio

**I.P FUSE BOX**

15A	1	DRL	10A	10	CLUSTER
10A	2	T/T BOX	10A	11	AIR BAG
10A	3	ROOM LAMP	30A	12	P/WINDOW
15A	4	DOOR LOCK	10A	13	T/SIGNAL
10A	5	STOP LAMP	15A	14	EMS
10A	6	REAR WIPER* (WIPER2)		15	
20A	7	FRONT WIPER (WIPER1)		16	
10A	8	BACKUP LAMP	15A	17	CIGAR
20A	9	BLOW MOTOR	10A	18	AUDIO
 <b>USE SPECIFIED FUSES ONLY.</b>					

## ENGINE COMPARTMENT FUSE BLOCK

1. Air Conditioning Compressor
2. Fan Low
3. Fan Hi
4. Antilock Brake System\*
5. Front Fog Lights\*
6. Horn
7. Illumination (Right)
8. Illumination (Left)
9. Spare
10. Spare
11. Spare
12. Left Low Beam Headlight
13. Right Low Beam Headlight
14. Main Power (Battery)
15. Ignition 2
16. Engine Management System
17. Spare
18. High Beam Headlight
19. Fuel Pump
20. Hazard

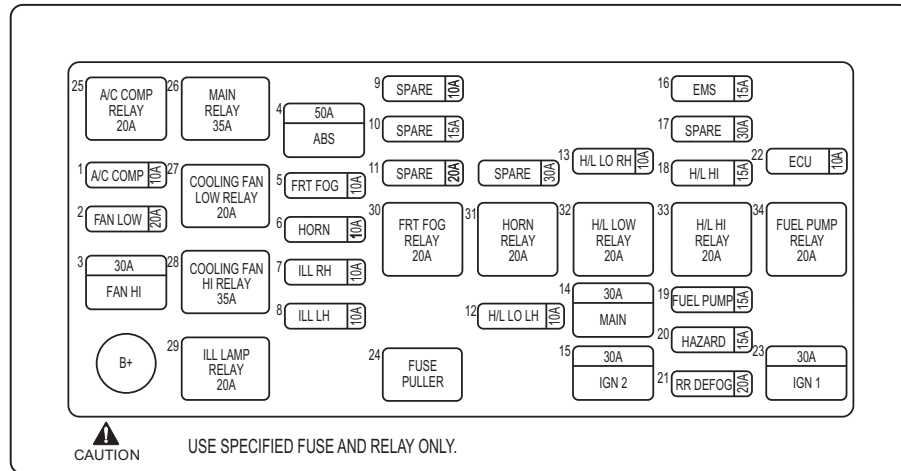

21. Rear Defogger\*
22. Engine Control Unit
23. Ignition 1
24. Fuse Puller
25. Air Conditioning Compressor
26. Main Power (Battery)
27. Low Cooling Fan

28. High Cooling Fan
29. Interior and Exterior Lights
30. Front Fog Lights\*
31. Horn
32. Low Beam Headlight
33. High Beam Headlight
34. Fuel Pump

## BULB REPLACEMENT

### ▲ CAUTION

Halogen bulbs contain pressurized gas and may burst if dropped or scratched. You or others may be injured. Follow all instructions on the bulb package.

- Wear eye protection during handling of bulb.
- Protect the bulb to avoid abrasion and scratches.
- When the bulb is illuminated and not in a sealed installation, protect it from contact with liquids.
- Only illuminate the bulb when it is installed in a lamp.
- Replace any headlamp that is cracked or damaged.
- Do not touch the glass shell of replaced bulb with your fingers or hands.
- Keep the bulbs away from children.
- Dispose of used bulbs with care. Otherwise the bulbs can explode.

### HEADLAMPS

1. Open the hood.
2. Remove the two bolts.
3. Disconnect the wiring harness connector from the bulb.
4. Remove the rubber cap covering the bulb assembly.
5. Release the spring that retains the bulb.
6. Remove the bulb.
7. Reverse the steps to install a new bulb.

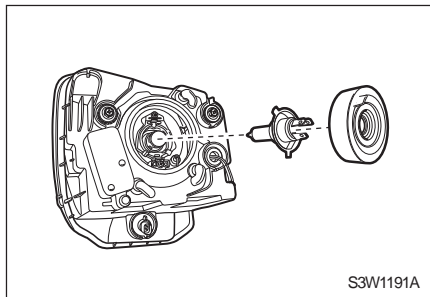

### ▲ CAUTION

Clean halogen bulbs with alcohol or mineral spirits and a lint-free cloth. Be sure not to touch them with your bare hands.

Fingerprints on a halogen bulb may drastically shorten the bulb's effective life.

### ▲ WARNING

The same rating of the bulb to be used during replacement and any usage of higher wattage bulbs can cause thermal issues such as melting of lamp housing and its surrounding parts.

Warranty would be void if higher wattage bulbs are being used.

**PARKING LAMPS**

1. Open the hood.
2. Remove the headlamp assembly.
3. Remove the rubber cap covering the bulb assembly.
4. Pull out the parking lamp bulb assembly located next to the headlamp bulb.
5. Pull the bulb straight out to remove it from the socket.
6. Reverse the steps to install a new bulb.

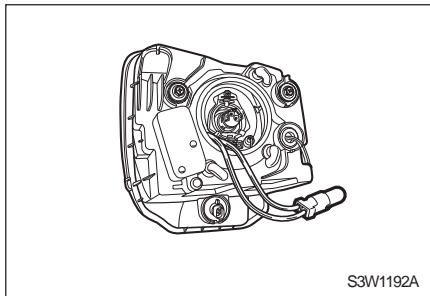
**FRONT TURN SIGNAL LAMPS**

1. Open the hood.
2. Remove the headlamp assembly.
3. Turn the bulb socket counterclockwise to unlock the socket from the housing.
4. Pull the bulb assembly out of the lamp housing.
5. Gently push in and turn the bulb counterclockwise to remove it from the socket.

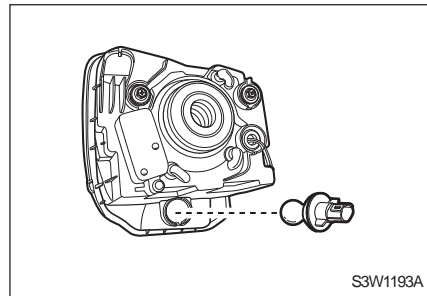

6. Reverse the steps to install a new bulb.

When installing the new bulb into the socket, press it in while turning it clockwise.

When installing the socket into the housing, rotate the socket clockwise.

### FRONT FOG LAMPS (Option)

**▲ CAUTION**

**Performing this vehicle maintenance procedure requires special skills, tools and equipment.**

**It is recommended that you have your CHEVROLET retailer perform this service.**

**Before attempting any service procedure yourself, make sure that you are very familiar with it and that you are confident you can complete it safely.**

**Otherwise, you could be injured or your vehicle could be damaged.**

1. Disconnect the wiring harness connector from the bulb.
2. Turn the bulb counterclockwise to remove it.
3. Reverse the steps to install a new bulb.

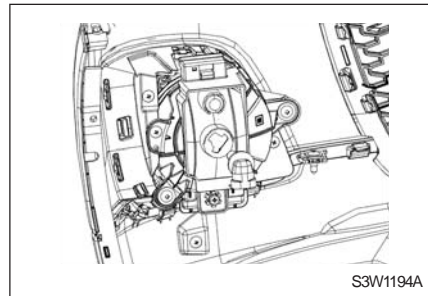

### SIDE TURN SIGNAL LAMPS

1. Pull the light assembly rearward and remove it.
  2. Turn the bulb socket counterclockwise.
  3. Pull the bulb straight out to remove it from the socket.
  4. Reverse the steps to install a new bulb.
- Make sure to push the light assembly back to its original position.

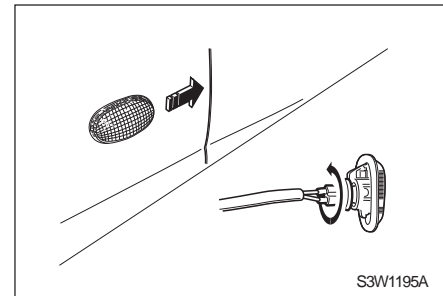

## TAILLIGHTS, STOPLAMPS, BACKUP LAMPS AND REAR TURN SIGNALS

1. Open the rear hatch.
2. Remove two screws from the lamp assembly.
3. Remove the lamp assembly.
4. Turn the bulb socket counterclockwise to remove it.
5. Gently push in and turn the bulb counterclockwise to remove it from the socket.
6. Reverse the steps to install a new bulb.

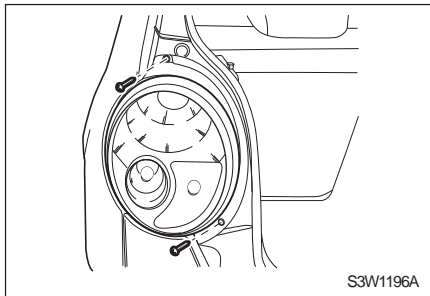

## CENTER HIGH-MOUNTED STOPLAMP

1. Open the rear hatch.
2. Remove two screws from the lamp assembly.
3. Disconnect the wiring harness connector before removing the lamp housing.
4. Remove the lamp housing.
5. Remove the two screws and remove the reflector assembly.
6. Pull the bulb straight out to remove it from the socket.
7. Reverse the steps to install a new bulb.

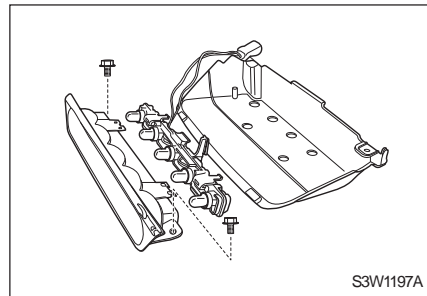

## SPORTY REAR SPOILER (Option)

High mount stop lamp is incorporated in the rear spoiler at the rear and it glows whenever service brake are applied. The integrated rear spoiler enhances aerodynamic performance, provides stable stance in high speed driving.

### LICENSE PLATE LAMP

1. Remove the two screws and the lamp cover.
2. Turn the bulb socket counterclockwise to remove it.
3. Pull the bulb out of the socket.
4. Reverse the steps to install a new bulb.

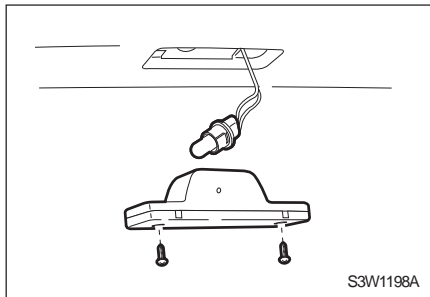

### DOME LAMP

1. Use the flat edge of a screwdriver to pry the lens away from the headliner.
2. Remove the bulb.
3. Reverse the steps to install a new bulb.

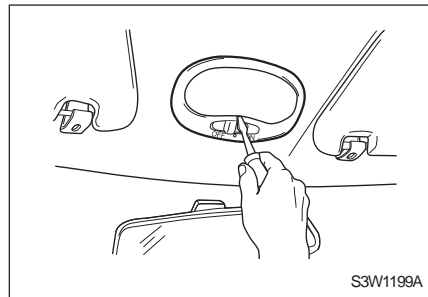

## VEHICLE CARE

### CLEANING AGENTS

Follow the manufacturer's advice whenever you use cleaning agents or other chemicals on the inside or the outside of your vehicle.

#### WARNING

**Some cleaners may be poisonous, corrosive, or flammable.**

- **Improper use of these cleaners can be dangerous. Their use may cause personal injury or damage to your vehicle.**

When cleaning the inside or outside of your vehicle, do not use hazardous cleaning solvents such as:

- Acetone.
- Lacquer thinners.
- Enamel reducers.
- Nail polish removers.

When cleaning the inside or outside of your vehicle, do not use cleaning materials such as the following, except as noted in the fabric cleaning advice on stain removal:

- Laundry soaps.
- Bleaches.
- Reducing agents.

Never use the following for any cleaning purpose:

- Carbon tetrachloride.
- Gasoline.
- Benzene.
- Naphtha.

 **WARNING**

- **Avoid overexposure to vapors from cleaning agents and other chemicals.**

**Such vapors can be dangerous and they may cause health problems which are more likely to occur in small, unventilated spaces.**

Open the doors to allow proper ventilation when you use any cleaning agents or other chemicals in the vehicle interior.

 **CAUTION**

**Do not let non color-fast fabrics come in contact with the interior trim of your vehicle, unless both materials are completely dry.**

To avoid the possible permanent discoloration of light-colored interior trim, do not let non color-fast materials come into contact with seat trim unless both materials are completely dry. Following is a brief list of fabric items which may contain non color-fast:

- Casual clothing.
- Colored denim.
- Corduroy.
- Leather.
- Suede.
- Newspaper.
- Decorative paper items.

## CARE AND CLEANING OF THE INTERIOR

 **CAUTION**

- **Make sure to use the proper cleaning techniques and materials when you clean the trim of your vehicle.**

**Failure to do so, especially on the first cleaning, may result in water spots, rings, and permanent stains.**

**These can permanently damage your vehicle.**

It is very important to use the proper techniques and cleaners on the interior and exterior of your vehicle.

Use a vacuum cleaner or soft bristle brush frequently to remove dust and loose dirt that collect on the interior fabrics.

Wiped vinyl and leather trim regularly with a clean damp cloth.

Clean normal soil, spots, or stains from the trim with appropriate cleaners.



 CAUTION

**Liquefied fragrances must not be installed on instrument panel area.**

**The surfaces of painted plastic parts may get damaged because of the peculiar ingredients of liquefied fragrances.**

**Safety belt care**

 CAUTION

**You must keep your safety belts in proper working condition to maintain their effectiveness.**

Always keep the safety belts clean and dry. Avoid contamination of the safety belt webbing by polishes, oils, and chemicals, particularly battery acid, bleach or dye. These contaminants may lead to weakening of your safety belt webbing material.

Periodically inspect all parts of the safety belts. Replace damaged safety belts or components immediately.

You must replace any safety belt that has been stretched in an accident, even if the damage is not obvious or visible. Replacement safety belts must be new.

We recommend replacing the entire safety belt assembly after your vehicle has been in a collision. If a CHEVROLET retailer finds that no safety belt damage has occurred in an accident, and that everything is in proper working order, then you don't have to replace the belts.

**GLASS SURFACES**

 CAUTION

**Abrasive cleaners can scratch the glass and damage the rear window defogger gridlines.**

- **Never use abrasive cleaners on vehicle glass.**

**Such damage can impair the driver's vision.**

Keeping the window glass clear will reduce glare and improve visibility.

 CAUTION

**Decals may damage the rear window defogger.**

- **Never place decals on the inside of the rear window.**

**Such damage can impair the driver's vision.**

**Cleaning the outside of the windshield**

Wax or other material on the windshield or the blade of the windshield wiper can cause the wiper blade to chatter during operation. Such foreign materials also can make it difficult to keep your windshield clean.

Periodically use a non-abrasive cleaner on the outside of the windshield.

**Water will not bead on a clean windshield.**

**CARE AND CLEANING OF THE EXTERIOR****Washing your vehicle**

The best way to preserve the finish of your vehicle is to keep it clean by washing it frequently.

- Park your car out of direct sunlight.
- Use mild soap specified for washing cars with cold or lukewarm water.
- Make sure to rinse all soaps and cleaners completely off the surface.

**NOTE**

- **Do not use household dishwashing liquid to wash your car.**

**Dish soap will wash car wax off your paint.**

**CAUTION**

- **Avoid high-pressure car washes.**

**They may cause water to enter your vehicle, damaging the interior.**

**We designed your vehicle to withstand normal environmental conditions and natural elements.**

**CAUTION**

**Your antenna could be damaged by the automatic car wash.**

- **Remove your mast or roof antenna manually.**

### Polishing and waxing

Periodically polish your vehicle to remove surface residue. After polishing, protect the paint with a high quality automotive wax.

### Protecting exterior bright metal parts

Clean bright metal trim parts regularly. Washing with water is all that is usually needed.

 **CAUTION**

- **Never use an automotive or chrome polish, steam, or a caustic soap to clean or polish aluminum trim.**

**Such materials can be too abrasive, resulting in damage to trim and wheels.**

When waxing your car, also wax all bright metal parts.

### Cleaning aluminum wheels and wheel covers

To preserve the original appearance of the wheels and wheel covers, keep them free from road dirt and brake dust buildup.

 **CAUTION**

**Do not use abrasive cleaners or brushes to clean aluminum wheels or wheel covers.**

Clean the wheels/wheel covers regularly, avoiding abrasive cleaners or brushes that can damage the finish.

### CORROSION PROTECTION

We designed your vehicle to resist corrosion. Special materials and protective finishes used on most parts of your car help maintain its good appearance, strength, and reliability.

Surface rust may appear on certain components found in the engine compartment or under the body eg. Silencers, Axle, Brake Disc, Brake Drums, Exhaust Manifold etc. but will not affect the reliability or function of these components.

### Sheet metal damage

If the vehicle needs body repair or replacement, make sure the repair shop applies proper anticorrosion material to restore corrosion protection. See “Finish damage” later in this section.

### Foreign material deposits

The following materials may damage painted surfaces:

- Calcium chloride and other salts.
- Ice-melting agents.
- Road oil and tar.
- Tree sap.
- Bird droppings.
- Industrial fallout.

Wash harmful materials off your vehicle promptly. If soap and water do not remove the residue, use cleaners specifically intended for this purpose.

#### CAUTION

- **Use only cleaners safe for use on painted surfaces.**

**Other cleaners may permanently damage the paint.**

### Finish damage

Repair stone chips, fractures, or deep scratches in the finish of as soon as possible. Bare metal corrodes quickly.

You may use touch-up products to repair minor chips and scratches.

A body and paint shop can make repairs on larger areas.

### Underbody maintenance

Corrosive materials can collect on the underbody of your vehicle. Failure to remove these materials can accelerate corrosion and rust.

Periodically use plain water to flush these materials from the underbody of your vehicle. Take care to clean any areas in which mud and other debris can collect. Loosen any sediment packed in closed area before flushing with water.

If you wish, your CHEVROLET retailer can provide this service for you.

#### NOTE

**When you wash the engine compartment, fuel, grease, and oil residue may be released into the environment.**

**Wash the engine at a CHEVROLET retailer or other location equipment with an oil separator in the car wash bay.**

**Dispose off the used engine oil, brake fluid, transaxle fluid, antifreeze, batteries, and tires at local authorized waste disposal facilities, or through a vendor who is under legal obligation to do so when you replace such materials.**

**Never place any of these items with household trash or pour them down drains.**

**Mishandling of such potentially hazardous materials can cause permanent environmental damage.**



# 8

## MAINTENANCE SCHEDULE

---

- GENERAL INFORMATION ..... 8-2
- SEVERE CONDITIONS ..... 8-2
- SCHEDULED MAINTENANCE SERVICES ..... 8-4

## GENERAL INFORMATION

This section provides the maintenance schedule which is necessary to ensure that your vehicle gives many years of satisfying motoring.

You are responsible for properly operating and maintaining your vehicle in accordance with the instructions described in this Manual. Failure to do so is likely to result in the denial of warranty coverage.

It is your responsibility to properly maintain and operate your vehicle. Be sure that you follow the periodic required maintenance schedule and general operation instructions in this Manual.

Every time a service / inspection is carried out you will be given the relevant completed and signed schedule, indicating the work which has been done.

It is also your responsibility to keep records and receipts as proof of regular maintenance. Records and receipts together with this Owner's Manual should be transferred to any subsequent owner.

You may have maintenance services performed on your vehicle by any qualified person or facility. However, it is recommended that the maintenance services be performed by an authorized CHEVROLET retailer who will have well-trained technicians and genuine parts.

Non-GMI genuine parts and accessories have not been examined or approved by GMI. GMI can certify neither the suitability nor the safety of non-genuine parts and accessories and are not liable for damage caused by their use.

Inadequate, incomplete, or insufficient servicing may result in operational problems with your vehicle that could even lead to vehicle damage, an accident, or personal injury.

## SEVERE CONDITIONS

You should follow the periodic required maintenance schedule. See "SCHEDULED MAINTENANCE SERVICES" later in this section.

## NORMAL CONDITIONS

The normal condition for driving means driving under typical, everyday driving conditions. You may follow the normal maintenance schedule.

## SEVERE CONDITIONS

If the vehicle is operated under any of the following conditions, some of the maintenance schedule items need to be serviced more frequently. See numeric symbols in "SCHEDULED MAINTENANCE SERVICES" later in this section.

- Repeated short-distance driving less than 5 miles (10 km).
- Extensive idling and/or slow-speed driving in stop-and-go traffic.
- Driving on dusty roads.

- Driving on hilly or mountainous terrain.

**▲ CAUTION**

**Chevrolet recommends to consult authorized CHEVROLET retailer for instructions and vehicle health check-up before setting out a long journey.**

- Towing a trailer.
- Driving in heavy city traffic where the outside temperatures regularly reach 90°F (32°C) or higher.
- Driving as a taxi, police or delivery vehicle.
- Frequent driving when outside temperature remains below freezing.

**Additional Operations**

The time allowance for additional operations, such as toothed belt replacement, are not included in the standard scope of service, and are charged separately. It is nonetheless advisable to have such work done as a part of a service check / inspection, since the time allowance are not as high as they would be if the work was carried out separately.



## 8-4 MAINTENANCE SCHEDULE

### SCHEDULED MAINTENANCE SERVICES

Maintenance services and record retention are the owner's responsibility. You should retain evidence that proper maintenance has been performed on your vehicle in accordance with the scheduled maintenance services chart.

*For vehicles with normal annual mileage.*

MAINTENANCE ITEM	Kilometers or time in months, whichever comes first											
	1 Month / 1000	6 Months / 5000	1 Year / 10000	2 Years / 20000	3 Years / 30000	4 Years / 40000	5 Years / 50000	6 Years / 60000	7 Years / 70000	8 Years / 80000	9 Years / 90000	10 Years / 100000
<b>ENGINE CONTROL SYSTEM</b>												
Drive Belt (Alternator, Power Steering and A/C Compressor)	I	I	I	I	I	I	I	I	I	I	I	I
Engine Oil and Engine Oil Filter (1) (3)	I	I	R	R	R	R	R	R	R	R	R	R
Cooling System Hose and Connections	I	I	I	I	I	I	I	I	I	I	I	I
Engine Coolant (3)	I	I	I	I	I	I	R	I	I	I	I	R
Fuel Filter	I	I	I	I	R	I	R	I	I	I	R	I
Fuel Line and Connections	I	I	I	I	I	I	I	I	I	I	I	I
Air Cleaner Element (2)	I	I	I	R	I	R	I	R	I	R	I	R
Spark Plugs	I	I	I	I	R	I	I	R	I	I	R	I
Ignition Cable	I	I	I	I	I	I	I	I	I	I	I	I
Valve Clearance		I	I	I	I	I	I	I	I	I	I	I
Charcol Canister and Vapor Lines					I			I			I	
PCV System	I				I			I			I	
Timing Belt					I			R			I	

#### Chart Symbols:

I- Inspect these items and their related parts. If necessary, correct, clean, replenish, adjust, rotate or replace.

R- Replace or change

- (1) If a vehicle is operated under severe conditions: short distance driving, extensive idling or driving in dusty conditions, change engine oil and the filter every 5,000 kms or 6 months, whichever comes first.
- (2) Inspect the air cleaner element every 5,000 kms or 6 months if vehicle is driven under dusty driving conditions. If necessary, correct, clean, or replace.
- (3) Refer to "FLUID CHART".

For vehicles with normal annual mileage.

MAINTENANCE ITEM	MAINTENANCE INTERVAL	Kilometers or time in months, whichever comes first											
		1 Month /1000	6 Months / 5000	1 Year / 10000	2 Years / 20000	3 Years / 30000	4 Years / 40000	5 Years / 50000	6 Years / 60000	7 Years / 70000	8 Years / 80000	9 Years / 90000	10 Years / 100000
<b>CHASSIS AND BODY</b>													
Exhaust Pipe and Mountings		I	I	I	I	I	I	I	I	I	I	I	
Brake / Clutch Fluid (3) (4)		I	I	I	R	I	R	I	R	I	R	I	R
Front Brake Discs & Pads (5)		I	I	I	I	I	I	I	I	I	I	I	
Rear Brake Drums & Linings (5)		I	I	I	I	I	I	I	I	I	I	I	
Parking Brake		I	I	I	I	I	I	I	I	I	I	I	
Brake Line & Connections (Including Booster)		I	I	I	I	I	I	I	I	I	I	I	
Rear Hub Bearing and Clearance		I	I	I	I	I	I	I	I	I	I	I	
Manual Transaxle Fluid : Leak Check (3)		I	I	I	I	I	I	I	I	I	I	I	
Clutch and Brake Pedal Free Play		I	I	I	I	I	I	I	I	I	I	I	
Chassis and Underbody Bolts and Nuts Tight/Secure		I	I	I	I	I	I	I	I	I	I	I	

**Chart Symbols:**

I- Inspect these items and their related parts. If necessary, correct, clean, replenish, adjust, rotate or replace.

R- Replace or change

(3) Refer to "FLUID CHART".

(4) Change the brake fluid every 10,000 kms or 1 years (whichever is earlier) if the vehicle is mainly driven under severe conditions:

- Driving in hilly or mountainous terrain, or
- Towing a trailer frequently.

(5) More frequent maintenance is required if under severe condition: short distance driving, extensive idling, frequent low-speed operation in stop-and go traffic or driving in dusty conditions.

## 8-6 MAINTENANCE SCHEDULE

*For vehicles with normal annual mileage.*

MAINTENANCE ITEM	Kilometers or time in months, whichever comes first											
	1 Month / 1000	6 Months / 5000	1 Year / 10000	2 Years / 20000	3 Years / 30000	4 Years / 40000	5 Years / 50000	6 Years / 60000	7 Years / 70000	8 Years / 80000	9 Years / 90000	10 Years / 100000
<b>CHASSIS AND BODY</b>												
Tire Condition, Inflation Pressure & Rotation	I	I	I	I	I	I	I	I	I	I	I	I
Wheel Alignment (6)	As and when required or as suggested by CHEVROLET retailer.											
Wheel Balancing (6)	As and when required or as suggested by CHEVROLET retailer.											
Steering Wheel & Linkage	I	I	I	I	I	I	I	I	I	I	I	I
Power Steering Fluid and Lines (3)	I	I	I	I	I	I	I	I	I	I	I	I
Drive Shaft Boots	I	I	I	I	I	I	I	I	I	I	I	I
Safety Belts, Buckles & Anchorages	I	I	I	I	I	I	I	I	I	I	I	I
Lubricate Locks, Hinges & Hood Latch	L	L	L	L	L	L	L	L	L	L	L	L

### Chart Symbols:

I- Inspect these items and their related parts. If necessary, correct, clean, replenish, adjust, rotate or replace.

R- Replace or change

L- Lubricate

(3) Refer to "FLUID CHART".

(6) If necessary, rotate and balance wheels.

# 9

## TECHNICAL INFORMATION

---

- IDENTIFICATION NUMBERS ..... 9-2
- FLUID CHART ..... 9-3
- ENGINE OIL ..... 9-4
- BULB SPECIFICATIONS ..... 9-5
- VEHICLE SPECIFICATIONS ..... 9-6

## IDENTIFICATION NUMBERS

### VEHICLE IDENTIFICATION NUMBER

This number is the legal identifier for your vehicle.

The vehicle identification number is engraved in the top of the bulkhead.

### VIN PLATE LOCATION

The vehicle identification number (VIN) plate is attached to the top of the front panel support.

### ENGINE IDENTIFICATION NUMBER

The engine number is stamped on the cylinder block under the No. 4 exhaust manifold of the engine.

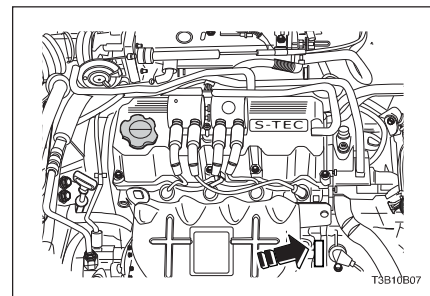
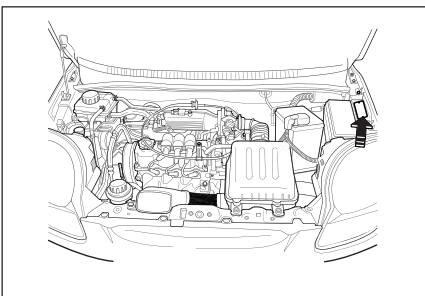
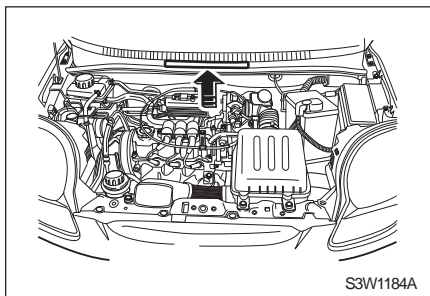

**FLUID CHART**

<b>Item</b>	<b>Capacity</b>	<b>Service Interval</b>	<b>Classification</b>
Engine oil (Including Oil Filter)	3.2L	Change every 15,000 kms or 1 year (whichever is earlier). Under severe condition change every 7,500 kms or 6 months (whichever is earlier). Oil filter element should be replaced at the same time.	5W-30 API SM GF4
Engine Coolant	4.2 L	Change every 52,500 kms or 3.5 years (whichever is earlier).	Ethylene Glycol Based Long Life Coolant
Manual Transaxle Fluid	2.1 L	Inspect every 15,000 kms or 1 year (whichever is earlier) and replenish if necessary. (Fluid change is not required).	SAE75W-85
Brake Fluid	0.5 L	Change every 30,000 kms or 2 years (whichever is earlier).	DOT4
Power Steering Fluid*	1.1 L	Inspect every 15,000 kms or 1 year (whichever is earlier) and replenish if necessary.	DEXRON VI

## ENGINE OIL

### API classification of engine oil

The International Lubricant Standardization and Approval Committee (ILSAC) and American Petroleum Institute (API) classify engine oils according to their performance quality. Always use oil rated API SM 5W-30.

#### Engine

Select an oil viscosity based on the outside air temperature. Do not switch to a different viscosity in the event of brief temperature fluctuations.

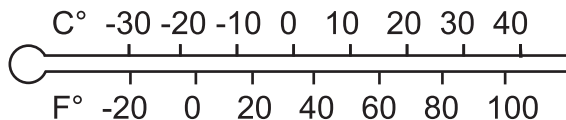

10W-30, 10W-40, 15W-40

5W-30

0W-20

HSB580BA

## BULB SPECIFICATIONS

Bulbs		Wattages x Quantity	Remarks	
Front	1	Headlamp (High/Low)	60/55W x 2	Halogen bulb
	2	Parking lamp	5W x 2	
	3	Turn signal lamp	21W x 2	Amber
	4	Fog lamp (Option)	27W x 2	Halogen bulb
	5	Side turn signal lamp	5W x 2	
Rear	6	Turn signal lamp	21W x 2	
	7	Brake / Tail lamp	21/5W x 2	
	8	Backup lamp	21W x 2	
	9	High mounted stop lamp (Option)	5W x 5	
	10	License plate lamp	5W x 2	
Interior		Dome lamp	10W x 1	

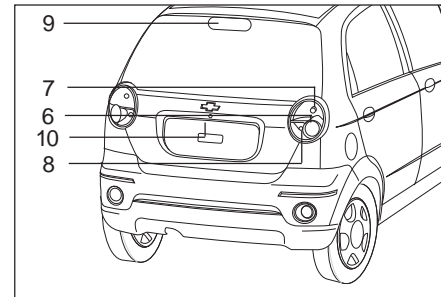
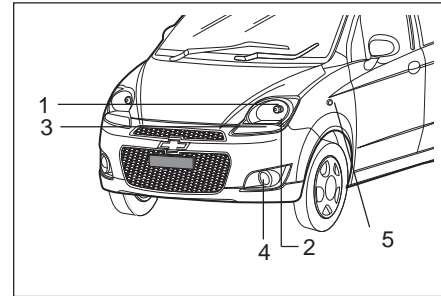

Bulb specifications in some models can be different from the above table. See the wattage printed on the bulb before replacing burnt bulbs.

**⚠ WARNING**

Customer should use only specified bulb in case of bulb replacement and use of higher bulb wattage can cause thermal issues such as lamp melting etc. Warranty would be void if higher wattage bulbs are being used.



## VEHICLE SPECIFICATIONS

### ENGINE

Engine		
Type	4-cylinder/in-line	
Valvetrain	SOHC 8 valves	
Displacement (cc)	995	
Bore x stroke (mm)	68.5 x 67.5	
Compression ratio	9.3 ± 0.3 : 1	
Max. Power (kW/rpm)	45.0/5400	
Max. Torque (Nm/rpm)	86.8/4200	
Fuel system	Multi-point injection	
Octane rating	See Page No. 5-4	
Spark plug	Type	R BPR5EY-11
	Gap (mm)	1.0 ~ 1.1
Battery	Rating (V-AH)	12 - 35
Alternator (V-A)		12 - 65
Starter (V-kW)		12 - 0.8

### DRIVETRAIN

5-Speed Manual Transaxle		
Drive system		Front wheel drive
Gear ratios	1 <sup>st</sup>	3.416
	2 <sup>nd</sup>	1.950
	3 <sup>rd</sup>	1.280
	4 <sup>th</sup>	0.971
	5 <sup>th</sup>	0.757
	Reverse	3.272
	Final drive ratio	4.440

**CHASSIS**

Chassis		
Front suspension type		McPherson struts with stablizer bar
Rear suspension type		Torsion beam axle
Steering	Type	Rack & Pinion system Manual Power assisted (Option)
	Overall gear ratio	21.1:1 (Manual) 16.45:1 (Power)
	Steering wheel diameter (mm)	370
	Minimum turning radius (m)	4.47

**BRAKE SYSTEM**

Brake system	
Type	Hydraulic, Vacuum assisted, Diagonal - dual circuit, with auto slack adjuster
Front wheel	Solid disc
Rear wheel	Drum
Booster size, mm (diameter)	178

**WHEEL AND TIRE**

Wheel and Tire			
Tire size	Wheel dimension	Tire Pressure (kPa) [psi]	
		Front	Rear
155/70 R13 75H/T	4.5J x 13	210 [30]	210 [30]

**CAPACITIES**

Capacities	
Fuel tank (L)	35.0
Engine oil (L)	3.2 (including oil filter)
Coolant (L)	4.2

**WEIGHT**

Weight		
Kerb weight (kg)	M/T	Base-823 / LS-828 / LT-840
Gross vehicle weight (kg)	M/T	1,270

**DIMENSIONS**

Exterior dimensions		
Overall length (mm)		3,495
Overall width (mm)		1,495
Overall height (mm)		1,518
Wheel base (mm)		2,345
Ground clearance (mm)		170
Track (mm)	Front	1,310
	Rear	1,275

# 10 24X7 ROADSIDE ASSISTANCE

• HOW TO REQUEST ASSISTANCE BENEFITS .....	183	• NON COVERED EVENTS UNDER THE CHEVROLET ROADSIDE ASSISTANCE PROGRAM .....	184
• COVERED AREA .....	183	• SPECIAL EXCLUSIONS .....	186
• CHEVROLET ROADSIDE ASSISTANCE AT HOME OR ON THE ROAD .....	183	• ADVERSE WEATHER .....	186
• VEHICLE RECOVERY FOLLOWING MECHANICAL OR ELECTRICAL BREAKDOWN .....	183	• FORCE MAJEURE .....	187
• VEHICLE RECOVERY FOLLOWING AN ACCIDENT	184	• EXTERNAL FACTORS .....	187
• TAXI BENEFIT .....	184	• RIGHT OF REFUSAL .....	187
• URGENT MESSAGE RELAY .....	184	• DISPUTES .....	187
• LOCKED KEYS/LOST KEY .....	184	• SUMMARY .....	187
		• DISCLAIMER .....	188



24x7x365 Days Access  
to Toll Free Number



Fuel Assistance



Taxi Assistance



Tyre Assistance



Key Lockout  
Services



Towing Facility



Battery Jump  
Start

The Chevrolet Roadside Assistance Program is focused to enhance your overall Chevrolet ownership experience by providing 24x7 Roadside Assistance emergency support for a period of three years starting from the date of invoice of the Chevrolet vehicle sold from an authorized CHEVROLET retailer, in the unfortunate event of vehicle breakdown or accident of your Chevrolet vehicle. The Chevrolet Roadside Assistance Program has specially been designed to take care of your car's safety and your comfort. The Benefits and the Terms & Conditions of the Chevrolet Roadside Assistance Program are mentioned in this Owner's Manual. You are therefore, requested to read this Owner's Manual very carefully.

### **HOW TO REQUEST ASSISTANCE**

In the event of a breakdown or accident, simply call the Chevrolet 24x7 Roadside Assistance Program on Toll Free Number\* 1800 103 8090. (\*In case of difficulty in reaching this toll-free number from your phone network, please dial 0124-4388090. Call charges apply.)

Please have the following information in hand when you call for assistance:

1. Your name and contact phone number.
2. Vehicle registration number.
3. Vehicle identification number (VIN) mentioned in the vehicle registration certificate.
4. Vehicle model.
5. Date of invoice.
6. Name of the authorized retailer from whom Chevrolet vehicle was purchased.
7. Brief description of the problem faced.
8. Specific location of the vehicle along with the nearest landmark.

The Chevrolet Roadside Assistance Program is available only if the above mentioned dial-in numbers are contacted.

### **REMARKS**

1. Once you have called Chevrolet Roadside Assistance Program, it is advisable that you stay with your vehicle.
2. Park your vehicle on the edge of the road and put the hazard warning lights on.
3. If you are on a highway, place the warning triangle provided with the Chevrolet vehicle approximately 3 meters from the vehicle in the direction of the on-coming traffic.

## **BENEFITS**

Chevrolet Roadside Assistance Program can be availed when your vehicle is immobilized due to:

1. Mechanical or electrical breakdown.
2. Road traffic accident where the vehicle is immobilized.
3. Human error.
4. Battery problems: Dead battery.
5. Fuel problems: Out of fuel, incorrect fuel or contaminated fuel.
6. Key problems: Locked keys, lost keys or broken vehicle keys.
7. Tyre problems: Puncture – replace with spare tyre available in the vehicle, bolts or valve related issues.

## **COVERED AREA**

Customers are entitled to the Benefits provided under this Chevrolet Roadside Assistance Program on a PAN India level (only exception in coverage is Andaman Nicobar Islands, where this Chevrolet Roadside Assistance Program is currently not available), provided however the Chevrolet vehicle has broken down on gazette, bitumen/concrete road. Chevrolet Roadside Assistance Program will also be provided to a customer when at home, on the roadside, on the highway, in a parking lot, etc., but if you are already at an authorized CHEVROLET retailer, then you are not entitled to the Benefits under the Chevrolet Roadside Assistance Program.

### **CHEVROLET ROADSIDE ASSISTANCE AT HOME OR ON THE ROAD**

If your Chevrolet vehicle is immobilized whether at home or on the road, Chevrolet Roadside Assistance Program personnel will attend to your Chevrolet vehicle. If the problem is something that can be resolved at the roadside, a mobile technician will be sent to mobilize your vehicle at the roadside.

### **VEHICLE RECOVERY FOLLOWING MECHANICAL OR ELECTRICAL BREAKDOWN**

If your Chevrolet vehicle is unable to be mobilized following a mechanical or electrical breakdown, a recovery vehicle will be sent to recover your Chevrolet vehicle to the nearest authorized CHEVROLET retailer.

## **VEHICLE RECOVERY FOLLOWING AN ACCIDENT**

If your Chevrolet vehicle is unable to be mobilized following a road traffic accident, Chevrolet Roadside Assistance Program personnel will organize to send a recovery vehicle to recover your Chevrolet vehicle to the nearest authorized CHEVROLET retailer, however all the costs towards repairs will be borne exclusively by you.

## **TAXI BENEFIT**

If your Chevrolet vehicle is recovered to an authorized CHEVROLET retailer by Chevrolet Roadside Assistance Program personnel, the driver and passengers, if any, of the Chevrolet vehicle will be provided with one free taxi ride, up to 50 kms from the breakdown location, in order to continue your journey. The maximum number of persons that can avail this facility would, at no point of time, exceed the number of people including the driver, Chevrolet vehicle is permissible to carry under the applicable rules and regulations.

## **URGENT MESSAGE RELAY**

You will be provided an urgent message relay service to help keep in contact with family, friends and/or work colleagues in the event of a vehicle breakdown or accident.

## **LOCKED KEYS/LOST KEY**

Whilst we will always endeavor to provide assistance by the most efficient method, however, modern security systems sometimes make it extremely difficult for us to gain entry to your vehicle at the roadside should the spare keys not be available. If a forced emergency entry is required, you will be asked to provide the approval granting the Chevrolet Roadside Assistance Program personnel the requisite permission to gain this access and further confirm that all repair costs relating to any resulting damages to your vehicle will be your sole responsibility and borne by you or customer's car may be towed to nearest authorized CHEVROLET retailer. In the event of lost key, provision of retrieving spare key from home will be provided only, if the event has occurred in the city you are residing.

## **NON COVERED EVENTS UNDER THE CHEVROLET ROADSIDE ASSISTANCE PROGRAM**

Chevrolet Roadside Assistance Program is designed to help in events that lead to stoppage / immobilization of your vehicle. As a result, this program will not cover any of the following events that you may encounter while driving your vehicle:

1. Faulty fuel gauge.
2. Speedometer not working.
3. Air-conditioning not working.
4. When the passenger door (s) cannot be opened and there are no passengers in the vehicle.
5. Boot cannot be opened.
6. The front and/or rear demisters are not functioning.
7. Horn is not functioning. However, if the horn is sounding continuously, the Chevrolet Roadside Assistance Services will be provided.
8. Damaged door mirrors.
9. When the rear view mirror is damaged but it does not obstruct the driver's vision.
10. Damaged or faulty fuel cap but vehicle has not run out of fuel and there is enough fuel in the tank to enable the vehicle to reach the nearest authorized CHEVROLET retailer.
11. When the sunroof cannot be opened.
12. When the sunroof cannot be closed but weather conditions are fair and the vehicle is not exposed to any security risk.
13. When the windows cannot be opened.
14. When the windows cannot be closed but weather conditions are fair and the vehicle is not exposed to any security risk.
15. Seat adjuster is faulty but the vehicle can be safely driven.
16. When the passenger seat belts are faulty but there are no passengers in the vehicle.
17. Faulty security system unless the vehicle is immobilized or unless the alarm is sounding continuously.
18. Transmission stuck in sports/winter mode.
19. When the ABS lights are illuminated.
20. Air bag warning lights are illuminated.
21. Traction control lights are illuminated.



22. Other non-safety related lights/service warnings are illuminated.
23. When your vehicle runs out of windscreen wiper fluid.
24. Front windscreen wipers faulty but weather conditions are fair.
25. Rear windscreen wiper faulty.
26. Vehicle pick-up and drop for routine maintenance is not included.

### **SPECIAL EXCLUSIONS**

The following scenarios are special exclusions under the Chevrolet Roadside Assistance Program, and therefore neither CSIPL nor its authorized retailers will be responsible for any assistance/repair costs and are excluded from Chevrolet Roadside Assistance Program:

1. Vehicle is involved in motor racing, rallies, speed or endurance tests, practice runs or operated outside official roads.
2. Assistance is required as a result of wars, riots, uprising, mass political demonstrations, pillage, strike, use for military purposes or acts of terrorism, earthquake damage, freak weather conditions, atmospheric phenomena, nuclear transformation phenomena or radiation caused by artificial acceleration of atomic particles.
3. Breakdown is caused by deliberate damage, vandalism or participation in a criminal act or offence.
4. The immobilization is resulting from damage caused by intervention of the police or other authorities.
5. Any damage resulting from the use of the vehicle against the recommendations of the Owner's Manual.
6. Any consequential costs and/or damage to property as a result of a breakdown in or on the vehicle.
7. Any cost as a result of damage and or claim caused while the driver was operating the vehicle under the influence of alcohol, solvent abuse, drugs or other illegal substance.
8. Vehicles kept in a non-roadworthy condition or not serviced in accordance with the manufacturer's recommendations and any such other events that may be decided by CSIPL from time to time.

### **ADVERSE WEATHER**

On occasion of adverse weather conditions such as floods, heavy rain, thunder, lightening or other external factors, which may affect our ability to provide the services effectively and it may become physically impossible to assist you until the weather improves. During such time, our main priority will be to provide the necessary assistance to you and the passengers to be taken to a place of safety. The recovery of your vehicle may not be possible until the weather condition permits.

## **FORCE MAJEURE**

CSIPL shall not be liable for its inability to provide the services under the terms of service set out in this Owner's Manual if such inability to provide the services is caused or contributed by causes beyond CSIPL's reasonable control including but not limited to acts of god, acts of public enemy or statutory authorities or courts, terrorism, or any acts of any person engaged in subversive activity or sabotage, strikes, embargoes, public rallies and protests.

## **EXTERNAL FACTORS**

You agree and understand that though Chevrolet Roadside Assistance Program will make every effort to reach you once you have made the call and the call is registered however, external conditions including traffic could delay such an effort.

## **RIGHT OF REFUSAL**

Chevrolet Roadside Assistance Program shall have the right to refuse any or all benefits under the program, if it is found that the information furnished by you at the time of making the request for assistance are false.

## **DISPUTES**

All disputes arising out of this Roadside Assistance Program shall be submitted to a sole arbitrator to be appointed by CSIPL and the place of arbitration shall be CSIPL Office at Gurgaon, Haryana. The arbitration proceedings shall be governed by the Arbitration and Conciliation Act, 1996 and shall be conducted in English. The Courts of Delhi shall have the jurisdiction.

## **SUMMARY**

### **AFTER READING THIS OWNER'S MANUAL, YOU SHOULD UNDERSTAND:**

1. The scope of Chevrolet Roadside Assistance Program.
2. You should at all times retain the Owner's Manual and produce whenever required.
3. This Owner's Manual must remain with the Chevrolet vehicle, if the vehicle is resold.

If you have any questions, your authorized CHEVROLET retailer / Chevrolet Roadside Assistance will be happy to assist you.

## DISCLAIMER

CSIPL shall be under no liability whatsoever in respect of any loss or damages arising directly or indirectly due to any delay or non-delivery of the services under the CSIPL Roadside Assistance Program. In case the vehicle cannot be mobilized onsite, Customers are advised to use the towing facility as may be arranged by CSIPL Roadside Assistance Program Vendor personnel for taking the vehicle to the nearest authorized workshop. In no condition, shall the vehicle be towed to any unauthorized workshop. Customer agrees, that it shall be a condition precedent that the Customers remove their personal belongings like laptops, wallets, mobile phone and other such valuable items before allowing the Roadside Assistance Vendor personnel to tow the vehicle and also take an inventory list of other belongings inside the vehicle including, the current physical conditions of the vehicle like dents, scratches, tools and spare tyre and to verify the list before taking possession of the vehicle from the authorized workshop. CSIPL at its discretion may refuse to render these services to any such Customers who in the reasonable discretion of CSIPL is misrepresenting the facts, in relation to the vehicle or any other details sought by the Roadside Assistance call center or the personnel and/or in the event of unruly, rude, use of abusive and foul languages, physical abuse and such other similar behavior to the Roadside Assistance Vendor's personnel by the Customer or the occupant of the vehicle. CSIPL reserves the right to change or modify any of the services and the charges thereto that are rendered in this Roadside Assistance Program without any notice.

FIND NEW ROADS



**24x7** ROADSIDE  
ASSISTANCE



**1800-103-8090**  
(Toll Free No.)  
**0124-4388090**

# 11 SERVICE NETWORK

---

- CHEVROLET SALES INDIA  
SALES AND SERVICE NETWORK ..... 11-3
- NORTH ZONE ..... 11-4
- WEST ZONE ..... 11-10
- SOUTH ZONE ..... 11-15
- EAST ZONE ..... 11-20
- INTERNATIONAL ..... 11-23

## 11-2 SERVICE NETWORK

---

## CHEVROLET SALES INDIA SALES AND SERVICE NETWORK

- ★ Indicates Retailer (Sales and Service)
- Indicates Chevrolet Authorized Service Center

Authorized Service Center (ASC) are authorized to carry out Periodic Maintenance (Free/Paid, Minor Running Repair) only.

The list of authorized Retailer / ASC are mentioned herein as of January, 2015. For any change in authorized Retailer / ASC, please visit [www.chevrolet.co.in..](http://www.chevrolet.co.in..)

## NORTH ZONE

### STATE - DELHI

- ★ **Ganganagar Automobiles Pvt. Ltd.**  
(Aarav Chevrolet)  
**Showroom :**  
11 - A, Shivaji Marg, Moti Nagar,  
Opp. L & T Building, New Delhi - 110 015  
Tel. : 011 - 41238888
- Workshop :**  
56, Rama Road, Opposite Radha Palace Banquet Hall,  
New Delhi -110 015  
Tel. : 011 - 49258888, 8826292810, 8826292815
- ★ **Arya Automobiles**  
**Showroom :**  
Plot No. 193, Metro Pillar No. 543,  
Main Rohtak Road, Mundka, New Delhi - 110 041  
Tel. : 011 - 8743030301 / 302  
Fax : 011 - 28342887
- Workshop :**  
KH-82/21/2 & 22/2, Phirmi Road, Udyog Nagar  
Industrial Area, Near Mundka Metro Pillar No. 547,  
New Delhi - 110 041  
Tel. : 011 - 28342884
- ★ **Go Auto Pvt. Ltd.**  
**Showroom :**  
A 231, Okhla Industrial Area, Phase-1,  
New Delhi - 110 020  
Tel. : 011 - 41855500, 9015444555
- Workshop :**  
B-25, Okhla Industrial Area, Phase-1,  
New Delhi - 110 020  
Tel. : 011 - 41955500, 9015777888

- ★ **Globus Motocorp Pvt. Ltd.**  
**Showroom :**  
ZB-43 & 44/487, Zulphe Bengal, Main GT Road,  
Dilshad Garden, Delhi - 110095  
Tel. : 011 - 43355555
- Workshop :**  
B-31, Jhilmil Industrial Area, Behind Jhilmil Metro  
Station, New Delhi - 110095  
Tel. : 011 - 43388888
- ★ **Metro Motors Pvt. Ltd.**  
**Showroom & Workshop :**  
Bawa Potteries Industrial Complex,  
Aruna Asaf Ali Marg, Vasant Kunj - 110 070  
Tel. : 011 - 41761717, 46156666
- Showroom 2 :**  
A-2/6, Safdarganj Enclave,  
Africa Avenue, New Delhi - 110 029  
Tel. : 011 - 46146666 / 75
- ★ **Sparsch Autotech Pvt. Ltd.**  
**Showroom :**  
D-12 & 13, Rajapuri, Madhuvihar, Opp. Sector-5,  
Dwarka, New Delhi -110075  
Tel.: 011- 49115911
- Workshop :**  
32/8, Shanti Garden, Matiala Industrial Area,  
Near DPS School, Dwarka, New Delhi -110059  
Tel.: 011- 49116911
- ★ **Triumph Motors**  
**Showroom :**  
A-9/3 Wazirpur Industrial Area, Near Richi Rich,  
New Delhi - 110 052  
Tel. : 011 - 47444666  
Fax : 011 - 42475584
- Workshop 1 :**  
C-13, Plot No. 65, SMA Industrial Area, GTK Road,  
Opp. Jahangir Puri, Azadpur, New Delhi - 110 033  
Tel. : 011 - 47444777

### Workshop 2 :

G-14, Udyog Nagar, Rohtak Road, Peeragarhi,  
Delhi - 110 041  
Tel. : 011 - 42010101  
Fax : 011 - 42010132

### STATE - HARYANA

- AMBALA**
- ★ **Ambala Automobiles India Ltd.**  
**Showroom :**  
Ramgarh, Near Central Jail Bridge, Chandigarh Road,  
Baldev Nagar, Ambala City - 134 003  
Tel. : 0171 - 2543010  
Fax : 0171 - 2543510
- Workshop :**  
Barwala, Naraingarh Road, Ambala City - 134 003  
Tel.: 0171 - 2678013
- BHIWANI**
- ★ **Shailesh Automobiles**  
**Showroom & Workshop :**  
Rohtak Road, Bhiwani - 127021  
Tel. : 01664 -204006/008
- DADRI**
- ★ **Shailesh Automobiles**  
**Showroom & Workshop :**  
Near Loharu Chowk, Bhiwani Road, Dadri - 127 306  
Tel. : 9253660069/70
- FARIDABAD**
- ★ **Regent Automobiles Ltd.**  
**Showroom :**  
14/3 , Mathura Road, Faridabad - 121 003, Haryana  
Tel. : 0129 - 4088530 / 31  
Fax : 0129 - 2252304
- Workshop 1 :**  
14/5, Main Mathura Road, Faridabad - 121 003  
Tel. : 0129 - 2252151 - 55, 4261200

**Workshop 2:**

Plot No.57, Sector-27C, Opp. Crown Interiorz Mall,  
13/1, Mathura Road, Faridabad - 121 003  
Tel.: 0129 - 2577777

**GURGAON**\* **Bhanu Motors Pvt. Ltd.****Showroom:**

Shop No. 4, Omaxe Wedding Mall, Main Sohna Road,  
Near Subhash Chowk, Gurgaon - 122001  
Tel. : 0124 - 4757777

**Workshop:**

Plot No. 541, Sector-37, Part-II, Gurgaon - 122001  
Tel. : 0124 - 4598888

\* **Gentech Toolings Pvt. Ltd.****Showroom & Workshop 1:**

Plot No. 66, IDC, Opp. Sector - 14  
Mehrauli - Gurgaon Road, Gurgaon - 122 001  
Tel. : 0124 - 4638751 - 54, 4368787  
Fax : 0124 - 4638700

**Showroom 2:**

DLF City Court, Sikanderpur, Gurgaon - 122001  
Tel. : 9582216504, 9582216510

○ **Orix Auto Infrastructure Services Ltd.****Workshop:**

7B, Sector - 18, Maruti Industrial Area,  
Gurgaon - 122 015  
Tel. : 0124 - 3014700 / 701 / 719  
Fax : 0124 - 3014702

**YAMUNA NAGAR**\* **Obero Motors****Showroom & Workshop:**

Aggarsain Chowk, Near Gupta Palace,  
Jagadhri - 135 003  
Tel. : 01732 - 212030, 212010

**KURUKSHETRA**\* **VPS Speciality Papers****Showroom & Workshop:**

Plot No.145 & 146, Industrial Area, Sector 2,  
Kurukshetra - 136 118  
Telefax : 01744 - 231050

**HISSAR**\* **Ashwani Automotors****Showroom & Workshop:**

9 km Stone, OP Jindal Marg, Hissar - 125 044  
Tel. : 01662 - 220710 / 11 / 12

**JHAJJAR**\* **Shailesh Automobiles****Showroom & Workshop:**

Tehsil Road Jhajjar, Haryana - 124 001  
Tel. : 9253660066 / 9254171300

**JIND**\* **Lekh Raj Motors Pvt. Ltd****Showroom & Workshop:**

Safidon Road, opp. Brahmin Dharamsala, Jind.  
Tel. : 9992900082

**KAITHAL**\* **Lekh Raj Motors Pvt. Ltd.****Showroom & Workshop:**

Ambala Road, Kaithal, Haryana - 136 027  
Tel. : 0174 - 6226827

**KARNAL**\* **Aryaman Automobiles****Showroom & Workshop:**

117/6, K.M. Milestone, Near Hotel New  
World, G. T. Road, Karnal - 132 001  
Tel. : 0184 - 2220011, 2220325  
TeleFax : 0184 - 2220025

**PANIPAT**\* **Aryaman Motors****Showroom & Workshop:**

Plot No 64, Sector -25, Huda Industrial Area Phase 1,  
Panipat - 132 103  
Tel. : 0180 - 2666222 / 2666800

**ROHTAK**\* **Badhwar Automobiles Pvt. Ltd.****Showroom & Workshop:**

Sonepat Road, Rohtak - 124 001  
Telefax : 01262 - 256666

**REWARI**\* **Vardhman Automobiles Pvt. Ltd.****Showroom & Workshop:**

Opp. Gurudwara, Jhajhar Road, Rewari - 123 401  
Tel. : 01274 - 250440 / 251188  
Fax : 01274 - 255966

**SONIPAT**\* **Malwa Motors Sales Pvt. Ltd.****Showroom & Workshop:**

NH-1, 31 Km Stone, G.T. Road, Kundli,  
Sonipat - 131 001, Haryana  
Tel. : 0130 - 2219384 - 85, 2370386, 2371386  
Fax : 0130 - 2219384

**SIRSA**\* **Padam Motors Pvt. Ltd.****Showroom & Workshop:**

Hisar Road, Opp Traffic Police Post, Sirsa - 125 055  
Tel. : 01666 - 244445  
Fax : 01666 - 244442

**STATE - HIMACHAL PRADESH****KANGRA**\* **Himachal Autowheels Pvt. Ltd.**

(Platinum Chevrolet)

**Showroom & Workshop:**

N.H 20 Kachhiary, Kangra - 176 001  
Tel. : 01892 - 260600/260601

**MANDI**\* **Ram Hari Motors Pvt. Ltd.****Showroom & Workshop:**

Rani Ki Bain, Gutkar, Mandi - 175 021  
Tel. : 01905 - 225692  
Fax : 01905 - 221691



## 11-6 SERVICE NETWORK

★ **MANALI**  
**Ram Hari Motors Pvt. Ltd.**  
**Showroom & Workshop :**  
Rotang Road, Village Vishisht Vihal, PO Vashisht,  
Tehsil - Manali, Distt - Kullu, Manali - 175 131  
Tel. : 01902 - 254001

**SOLAN**  
★ **Rajvir Motors**  
**Workshop :**  
Kalka Shimla Road, Near Mehta Market,  
Kumarhatti, Solan, Himachal Pradesh - 173 229  
Telefax : 01792 - 266338

**UNA**  
★ **Bhagat Ram Motorways Pvt. Ltd.**  
**Showroom & Workshop :**  
Una Nangal Road, Rakkar Colony, Una - 174 303  
Tel. : 01975 - 238799  
Fax : 01975 - 238699

### STATE - PUNJAB

**AMRITSAR**  
★ **S V Motors**  
**Showroom :**  
Near Amritsar Gate, GT Road, Amritsar - 143 001  
Tel. : 0183 - 2700102  
Fax : 0183 - 2700101

**Workshop :**  
Main GT Road, Opp. ITBP Office, Amritsar - 143 001  
Tel. : 0183 - 2700201

**BATALA**  
★ **Kashmir Automobiles Pvt. Ltd. (Platinum Chevrolet)**  
**Showroom & Workshop :**  
Opp. Cambridge International School, Saidmubarak,  
Amritsar Road, Batala - 143 505  
Tel. : 01871 - 241024

**BHATINDA**  
★ **Padam Cars Pvt. Ltd.**  
**Showroom & Workshop :**  
Goniana Road, 8th Mile Stone, NH-10,  
Bhatinda - 151 005  
Tel. : 0164 - 27601111 / 9216350205  
Telefax : 0164 - 2760153

**CHANDIGARH**  
★ **Padam Motors Pvt. Ltd.**  
**Showroom :**  
182/2, Industrial Area, Phase 1, Chandigarh - 160 002  
Tel. : 0172 - 5212900

**Workshop :**  
185, Industrial Area, Phase 1, Chandigarh -160 002  
Tel. : 0172 - 5212999

**JALANDHAR**  
★ **Aakriti World**  
**Showroom :**  
Ground Floor, Vasal Tower, Police Lines,  
Opp. President Hotel, Jalandhar - 144 001  
Telefax : 0181 - 5003333

**Workshop :**  
1746 Ladowali Road, Near BSF Chowk,  
Jalandhar - 144 001  
Tel. : 0181 - 5057777

**LUDHIANA**  
★ **Padam Cars Pvt. Ltd.**  
**Showroom & Workshop :**  
Khasra No. 279/3, G.T. Road,  
Dhandari Kalan, Ludhiana  
Tel. : 0161 - 2510014  
Telefax : 0161 - 2510015

★ **Padam Motors Pvt. Ltd.**  
**Showroom & Workshop :**  
Near Ayalli Chowk, Ferozepur Road,  
Ludhiana - 141 001  
Tel. : 0163-6225755, 9780000609

★ **Omni Wheels Pvt. Ltd.**  
**Showroom & Workshop :**  
Plot No 73, New Kuldeep Nagar,  
Basti Jodhewal Chowk, Ludhiana - 141 007  
Tel. : 0161 - 5055900  
Fax : 0161 - 5055911

**ROPAR**  
★ **Padam Cars Pvt. Ltd.**  
**Showroom & Workshop :**  
Chandigarh Road, Nangal Chowk, Ropar - 140 001  
Telefax : 01881 - 500099

**MOGA**  
★ **Padam Cars Pvt. Ltd.**  
**Showroom & Workshop :**  
Near Majestic Resorts, Ferozepur Road,  
Moga - 142 001  
Tel. : 01636 - 225755

**NAWASHAHAR**  
★ **Aakriti World**  
**Showroom & Workshop :**  
Chandigarh Road, Nawashahar, Punjab - 144 514  
Tel. : 01823 - 285656  
Telefax : 01823 - 285858

**PATIALA**  
★ **Padam Cars Pvt. Ltd.**  
**Showroom & Workshop :**  
Main Patiala - Rajpura Road,  
Opp. Caspa Resort, Bahadurgarh, Patiala - 147 001  
Tel. : 0175 - 2663813 - 14, 9217100905 - 9  
Fax : 0175 - 2663828

**PATHANKOT**  
★ **Kashmir Automobiles Pvt. Ltd.**  
**Showroom & Workshop :**  
Simbel Chowk, Dalhousie Road, Pathankot - 145 001  
Tel. : 0186 - 2257022 - 24

**SANGRUR**

- \* **Padam Cars Pvt. Ltd.**  
**Showroom & Workshop:**  
 College Road, Opp. Kamal Palace, Sangrur - 148001  
 Tel. : 9216350134, 9216911461

**STATE - RAJASTHAN****AJMER**

- \* **Rajdeep Autowheels (P) Ltd.**  
**Showroom:**  
 12-15, ASC Road, Vaishali Nagar, Ajmer - 305001  
 Tel. : 0145 - 2628989 / 2625116

**Workshop:**

Khasara No-319 Kankarda Bhunaboy, NH-8,  
 Jaipur Road, Ajmer - 305001  
 Tel. : 0145 - 2788192 / 93 / 2788222 / 23

**ALWAR**

- \* **Triumph Motors**  
**Showroom & Workshop:**  
 Old Delhi Road, Near Jhankar Hotel, Alwar - 301 001  
 Telefax : 0144 - 3047571 - 78

**BHILWARA**

- \* **Rajdeep Autowheels (P) Ltd.**  
**Showroom & Workshop:**  
 Payal Resort, Ajmer Road, Bhilwara - 311001  
 Tel. : 01482 - 265164

**BIKANER**

- \* **Sunehri Cars**  
**Showroom & Workshop:**  
 Plot No. 15, Transport Nagar,  
 NH-15, Ganganagar Road, Bikaner - 334 001  
 Tel. : 8003399060 / 66 / 69

**BANSWARA**

- \* **Atharva Motors Pvt. Ltd.**  
**Workshop:**  
 Janamedi, Udaipur Road, Banswara - 327 001  
 Tel. : 02962 - 250227

**CHITTORGARH**

- \* **Atharva Motors Pvt. Ltd.**  
**Showroom:**  
 Plot No. 86, Kabir Colony, Bhilwara Road,  
 Chittorgarh - 312001  
 Tel. : 01472 - 247598  
 Fax : 01472 - 247598

**Workshop:**

Near Saint Paul's School, Opp. Rajasthan State  
 Seed Corp., Nimbhera Road, Chittorgarh - 312 001  
 Tel. : 01472 - 240598

**CHOMU**

- \* **Triumph Motors**  
**Showroom & Workshop:**  
 Near Radha Soami Bagh, Jaipur Road,  
 Chomu - 303 702  
 Tel. : 0142 - 3304000

**JAIPUR**

- \* **Triumph Motors**  
**Showroom 1:**  
 Corporate Tower, A-1, Jawahar Lal Marg,  
 Jaipur - 302 015  
 Tel. : 0141 - 4057575  
 Fax : 0141 - 4057500

**Showroom 2:**

C7D, Sawai Jai Singh Highway,  
 Bani Park, Jaipur - 302 016  
 Tel. : 0141 - 4122222  
 Fax : 0141 - 4122233

**Workshop 1:**

G-109A, Sitapura Industrial Area, Jaipur - 302 004  
 Tel. : 0141 - 5122333, 5113636, 5143737,  
 5122797, 5122798, 5143636, 4090409  
 Fax : 0141 - 5122552

**Workshop 2:**

E-12B, Vishwakarma Ind. Area, Road No. 01,  
 Jaipur - 302 013  
 Tel. : 0141 - 4255555

**Workshop 3:**

E1 - 2295, Ramchandrapura Industrial Area,  
 Sitapura Ext, Jaipur - 302 022  
 Tel. : 0141 - 4090409

**JHUNJUNU**

- \* **Triumph Motors**  
**Showroom & Workshop:**  
 G1-8, 9 & H1-16,17, Phase - 2, RIICO Industrial Area,  
 Jhunjunu - 333 001  
 Tel. : 01592 - 203163, 250001 - 3, 250145, 250146

**JODHPUR**

- \* **Atharva Motors Pvt. Ltd.**  
**Showroom:**  
 27/27A, Light Industrial Area,  
 Near Shastri Circle, ITI Road, Jodhpur - 342 003  
 Tel. : 0291 - 3048491

**Workshop:**

E-711, Mia Bsn, IInd Phase,  
 Behind Krishna Dharam Kanta, Jodhpur - 342 005  
 Tel. : 0291 - 3048217 - 22  
 Fax : 0291 - 3048223

**KOTA**

- \* **Triumph Motors**  
**Showroom & Workshop:**  
 E - 137C, Road No. 5,  
 Indraprastha Industrial Area, Kota  
 Tel. : 0744 - 2372333, 2372666

**PALI**

- \* **Atharva Motors Pvt. Ltd.**  
**Showroom & Workshop:**  
 Opp. Krishi Mandi, Jodhpur Road, Pali - 306 401  
 Tel. : 9414060104

**SIKAR**

- \* **Triumph Motors**  
**Showroom & Workshop:**  
 Near Circuit House, NH-11, Jaipur Sikar Road,  
 Sikar - 332 001  
 Tel. : 01572 - 245971

## 11-8 SERVICE NETWORK

### SRI GANGANAGAR

- \* **Sunehri Cars**  
**Showroom & Workshop:**  
6th Km Stone, Surat Garh Road, NH-15,  
Sri Ganganagar  
Tel. : 8003399070 / 71

### UDAIPUR

- \* **Atharva Motors Pvt. Ltd.**  
**Showroom & Workshop:**  
A-83, Mewar Industrial Area, Madri, NH-8,  
Ahmedabad Bye Pass, Udaipur - 313 002  
Tel. : 0294 - 3002730, 3002769  
Fax : 0294 - 2490108

## STATE - UTTAR PRADESH

### ALIGARH

- \* **Jattari Automobile**  
**Showroom & Workshop:**  
300 Mtr. From, Bharat Petrol Pump,  
Khair By Pass Road, Aligarh - 202001  
Tel. : 8938802229, 8938802214

### ALLAHABAD

- \* **Eldae Motors**  
**Showroom:**  
Eldae Enclave, 2, S. P. Marg, Civil Lines,  
Allahabad - 211 001  
Tel. : 0532 - 2560743, 44

### Workshop:

Kanodia Mill Compound 1, Luker Ganj,  
Allahabad - 211 001  
Tel. : 0532 - 2616368

### AGRA

- \* **Kalyan Auto Sales**  
**Showroom & Workshop:**  
Opp. Bhagwati Dhaba, Near New Sabji Mandi,  
Sikandra, Agra - 282 007  
Tel. : 0562 - 2640460 / 62 / 63  
Fax : 0562 - 2640461

### BAREILLY

- \* **VAT Motors Pvt. Ltd.**  
**Showroom & Workshop:**  
4.5 KM, Rampur Road, CB Ganj, Bareilly - 243 001  
Tel. : 0581 - 2560741  
Fax : 0581 - 2560731

### FAIZABAD

- \* **Megha Auto (I) Pvt. Ltd.**  
**Showroom & Workshop:**  
Lucknow Bypass Road, Sahadatganj,  
Faizabad - 224 001  
Tel. : 09839099210

### GORAKHPUR

- \* **United Motors**  
**Showroom:**  
Kasia By-pass Road, Near Dr. Riyaz Ortho Hospital,  
Mohaddipur, Gorakhpur - 273 001  
Tel.: 0551 - 2201667  
Fax.: 0551 - 2338299

### Workshop:

Saryu Nahar Colony, Singharia,  
Gorakhpur - Deoria Road, Gorakhpur - 273 008  
Tel.: 0551 - 2270231

### GHAZIABAD

- \* **Shiva Motors**  
**Showroom & Workshop:**  
28/3/5, Site - IV, Industrial Area, Sahibabad, Ghaziabad  
Tel.: 0120 - 3008600 / 605 / 631 / 632 / 635 / 636  
Fax: 0120 - 3008643 / 45 / 48 / 49 / 50

### Workshop 2:

58/3, Site 04, Sahibabad, Ghaziabad - 200 300  
Tel. : 0120 - 4558765

### JHANSI

- \* **Sri Venkateshwar Autocare Pvt. Ltd.**  
**Showroom & Workshop:**  
Jhansi Kanpur Road, Goramachhiya, Jhansi - 284 001  
Tel. : 0510 - 2371144, 6450158

### KANPUR

- \* **Cross Road Auto Pvt. Ltd.**  
**Showroom:**  
40, Government Industrial Estate,  
Opp. Sindhia Colony, Fazal Ganj, Kanpur - 208 012  
Tel.: 0512 - 2221276 / 2220043

### Workshop 1:

C-15A, Panki Industrial Area, Site-1, Kanpur - 208 012  
Tel.: 0512 - 2691293, 2691377

### Workshop 2:

122/236, A-1 & C-1, Fazalganj,  
Near Sangam Talkies, Kanpur - 208 012  
Tel.: 8009461111

- \* **Romi Motors Pvt. Ltd.**

**Showroom:**  
14/63, Civil Lines, Kanpur - 208 001  
Tel.: 0512 - 3224703

### Workshop:

120/192 (4), Lajpat Nagar,  
Near Mariampur Crossing, Kanpur - 208 012  
Tel. : 0512 - 3224701 / 3224702

### LUCKNOW

- \* **Megha Auto (I) Pvt. Ltd.**  
**Showroom & Workshop:**  
10/CP/5, Ring Road, Vikasnagar,  
Opp. Jagrani Hospital, Lucknow - 226 020  
Tel. : 0522 - 4057999 / 4007977 / 2330180

### Workshop 2:

Mishipur Depot, Near Sanatan Cold  
Storage, Kursi Road, Lucknow - 226 026  
Tel. : 0522 - 2890631

### MEERUT

- \* **Vardajyoti Automobiles Pvt. Ltd.**  
**Workshop:**  
Madhuban Cinema Bldg., Madhuban Colony,  
Baghpath Road, Meerut - 250 002  
Tel. : 0121 - 2404005 - 08  
Fax: 0121 - 2404009

**MORADABAD**

- ★ **Sigma Motors Pvt. Ltd.**  
**Showroom & Workshop:**  
 Near Radhakrishna Mandir,  
 Delhi Road, Moradabad - 244 001  
 Tel. : 0591 - 2550100 - 05, 7351007701 - 05,  
 7351003805

**MIRZAPUR**

- ★ **Saraswati Industries**  
**Showroom & Workshop:**  
 Pili Kothi, Station Road, Mirzapur - 231 001  
 Tel. : 05442 - 223923

**NOIDA**

- ★ **Shiva Motors**  
**Showroom:**  
 G-24, Sector 11, Noida - 210 301  
 Tel. : 0120 - 3920150 / 158

**Workshop:**

C-80/81A, Sector - 8, Noida  
 Tel. : 0120 - 3359807 / 813

**SAHARANPUR**

- ★ **DPM Autosales**  
**Workshop:**  
 Ambala Road, Near Badi Nahar, Saharanpur  
 Tel. : 0135 - 2640877

**VARANASI**

- ★ **Vinayak Automotive Pvt. Ltd. (Vinayak Chevrolet)**  
**Showroom & Workshop:**  
 Adjacent to Essar Petrol Pump,  
 Jagatpur, Rohania, Varanasi - 221 313  
 Tel. : 7703003320, 7703003330, 7703003321,  
 7703003333

**STATE - UTTARAKHAND****DEHRADUN**

- ★ **DPM Autosales**  
**Showroom & Workshop:**  
 Mohabewala Industrial Area,  
 Saharanpur Road, Dehradun  
 Tel. : 0135 - 2642051 / 52 / 53  
 Fax : 0135 - 2642054

**HALDWANI**

- ★ **Analysis Motors**  
**Workshop:**  
 7.5 km Stone, Gora Padav, Bareilly Road,  
 Haldwani - 263 641  
 Tel. : 05946 - 232050

**STATE - JAMMU & KASHMIR****JAMMU**

- ★ **K. C. Motors**  
**Showroom & Workshop:**  
 NH-1, Bypass Road, Jammu - 180 004  
 Tel. : 0191 - 2465769 / 59, 2460829  
 Fax : 0191 - 2476660

**RS PURA**

- ★ **K. C. Motors**  
**Showroom & Workshop:**  
 Bagha Marh, RS Pura, Jammu  
 Tel. : 01923 - 252809  
 Fax : 01923 - 252809

**SRINAGAR**

- ★ **K. C. Motors**  
**Showroom & Workshop:**  
 By Pass Road, Hyderpora, Srinagar - 190 014  
 Tel. : 0194 - 2443188

## WEST ZONE

### STATE - GOA

- ★ **VASCO-DA-GAMA**  
**Subrai Motors Pvt. Ltd.**  
Workshop:  
 F L Gomes Road, Vasco-Da-Gama, Goa - 403 802  
 Tel. : 0832 - 2517421 / 22  
 Fax : 0832 - 2513924

### STATE - GUJARAT

- ★ **AHMEDABAD**  
**Gallops Motors Pvt. Ltd.**  
Showroom & Workshop:  
 Near JCB Service Station, S.G. Highway,  
 Sarkhej, Ahmedabad - 380 015  
 Tel. : 079 - 2474346, 39835544, 39835501  
 Fax : 079 - 39835588
- Showroom 2:  
 A/8,9,10,11,12,13 & 14, Radhe Shopping Mall,  
 Khokhra, Maninagar, Ahmedabad  
 Tel. : 079 - 32941862 / 32440235
- Workshop 2:  
 Opp. Amraivadi Post Office, Near Hatkeswar Circle,  
 Maninagar, Ahmedabad - 380 026  
 Tel. : 079 - 30486501 / 02 / 03
- ★ **ANAND**  
**Shree Gopinathji Agencies**  
Workshop:  
 Survey No. 570 - A/2, Near Indira Statue,  
 Lambhavel Road, Anand - 388 001  
 Tel. : 02692 - 247979 / 247878
- ★ **BHARUCH**  
**Shree Gopinathji Agencies**  
Showroom & Workshop:  
 Beside K.U & Company Petrol Pump,  
 NH-8, Village Vadadala, Bharuch - 392 015  
 Tel. : 02642 - 654245, 291303, 654845  
 Telefax : 02642 - 231584

- ★ **BHAVNAGAR**  
**V Raj Motors**  
Showroom & Workshop:  
 Plot No. 150, Near Press Quarter,  
 Opp. Maruti Showroom, Bhavnagar-Rajkot Road,  
 Chitra, Bhavnagar - 364 003  
 Tel. : 0218 - 2444590, 2444445

- ★ **BHUJ**  
**Cargo Motors**  
Showroom & Workshop:  
 Plot No. 10, Survey No. 29/1,  
 Bhuj - Mirzapur Road, Bhuj - 370001  
 Tel. : 02832 - 654191 / 654192

- ★ **GANDHIDHAM**  
**Cargo Motors**  
Showroom & Workshop:  
 NH-8A, Kandla Port Road, Gandhidham - 370 201  
 Tel. : 02833 - 654370, 653317, 9825611692

- ★ **GODHRA**  
**Shree Gopinathji Agencies**  
Showroom & Workshop:  
 Moonlight Cinema Compound, Vavdi,  
 Godhra - 389 001  
 Tel. : 02672 - 645828, 265270, 265271

- ★ **GANDHI NAGAR**  
**Gallops Motors Pvt. Ltd.**  
Showroom & Workshop:  
 Near Nigam Petrol Pump, Rajshree Cinema Road,  
 Sector-21, Gandhinagar - 382 010  
 Tel. : 0232 - 30516107

- ★ **HIMMATNAGAR**  
**Gallops Motors Pvt. Ltd.**  
Showroom & Workshop:  
 Near Motipura Circle, Opp. S.T. Workshop,  
 Shamlaji Highway, Himmatnagar - 383 001  
 Tel. : 02772 - 229525, 229524, 308000, 308001

- ★ **JAM NAGAR**  
**Gallops Motors Pvt. Ltd.**  
Showroom:  
 Jamnagar - Rajkot Highway, Hapa,  
 Opp. Tata IB Motors, Jamnagar  
 Tel. : 0288 - 3216060

- Workshop:  
 Jamnagar to Rajkot Highway, 8 - Happa,  
 Jamnagar - 320 120  
 Tel. : 0288 - 3921194 - 98

- ★ **MEHSANA**  
**Gallops Motors Pvt. Ltd.**  
Showroom & Workshop:  
 Opp. Wide Angle, Nagalpur Highway,  
 Mehsana - 384 002  
 Tel. : 02762 - 241010, 302401 / 02 / 06  
 Fax : 02762 - 245151

- ★ **NAVSARI**  
**Monarch Motors**  
Showroom & Workshop:  
 Mahalaxmi Estate, Near Bhana Petrol Pump,  
 Near Grid Char Rasta, N.H. No. 8, Navsari - 396 424  
 Tel. : 02637 - 265788 / 265599

- ★ **PALANPUR**  
**Gallops Motors Pvt. Ltd.**  
Showroom & Workshop:  
 Survey No. 525/1, Palanpur - Delhi Highway,  
 Near Palanpur - Deesa Char Rasta, Palanpur - 385 001

- ★ **RAJKOT**  
**Gallops Motors Pvt. Ltd.**  
Showroom & Workshop:  
 Survey No. 219/220, Opp. Parin furniture,  
 Next to Jay Ganesh, AT & PO,  
 Kotharia Gondal Highway, Rajkot - 360 003  
 Tel. : 0281 - 3205151, 2370006 / 8 / 9 / 10,  
 3983400, 3983407

**SURAT**

- \* **Empire Cars Pvt. Ltd.**  
**Showroom & Workshop :**  
 Plot No. 3, Near Rangoli Hotel, Rundh,  
 Dumas Road, Surat - 395 007  
 Tel. : 0261 - 6713300 / 33
- \* **Monarch Cars Pvt. Ltd.**  
**Showroom :**  
 Umiya Nagar Society,  
 Near Shree Choshath Joganiyo Mata Mandir,  
 Udha Magdalla Road, Surat - 394 210  
 Tel.: 0261-2720481, 2720482, 09825274707
- Workshop :**  
 Next To Sameeti School, Patel Nagar Circle,  
 Udha Gam, Surat - 394 210  
 Tel.: 0261 - 3091001
- \* **Nanavati Motors**  
**Showroom :**  
 Orchid Tower, Opp Intercity Township,  
 Puna Kumbharia road, Surat - 395 010  
 Tel.: 9879114447
- Workshop :**  
 Opp. SBI Bank, Puna Patiya,  
 Puna Kumbhariya Road, Surat - 395 010  
 Tel. : 0261 - 6456449/429/430  
 Fax : 0261 - 2647771
- SURENDRA NAGAR**
- \* **Gallops Motors Pvt. Ltd.**  
**Workshop :**  
 Plot No. 267, GIDC Vadhan, Opp. Market Yards,  
 Near Rekha Bearings, Surendra Nagar  
 Tel. : 02752 - 321542 - 43
- VAPI**
- \* **Desai Automobiles**  
**Showroom & Workshop :**  
 At & Po : Baliha, Near Woodland Hotel,  
 National Highway No. 8,  
 Taluka Pardi, Vapi, Valsad - 395 015  
 Tel. : 0260 - 6531783, 2400250 - 51  
 Fax : 0260 - 2426525

**VADODARA**

- \* **Shree Gopinathji Agencies**  
**Showroom & Workshop :**  
 Opp. Gujarat Elec. Board Sub Station,  
 (Near Prakuti Resort), Chhani, Baroda - 390 002  
 Tel. : 0265 - 2761105 / 06
- Showroom & Workshop 2 :**  
 R. S. No. 7, Opp. Atladra Railway Station,  
 Atladra, Vadodara - 390 012  
 Tel. : 0265 - 2681050, 1060, 0187, 1010, 1020  
 Fax : 0265 - 2681050, 2354984
- Showroom & Workshop 3 :**  
 3/A, Sahajanand Industrial Estate,  
 Munjmahuda, Akota, Vadodara - 390 020  
 Tel. : 0265 - 2681010, 2681020, 2359898, 2334109  
 Fax : 0265 - 2681050, 2681060

**STATE - MADHYA PRADESH**

- BHOPAL**
- \* **Super Cars Ltd.**  
**Showroom & Workshop :**  
 Plot No. 21 Sector G, Govindpura Industrial Area,  
 J.K. Road, Bhopal - 462 021  
 Tel. : 0755 - 4028400, 4228201  
 Fax : 0755 - 4228203
- \* **Varenayam Motors**  
**Showroom & Workshop :**  
 189, Angoori Bagh, Jinsi Road, Bhopal - 462 008  
 Tel. : 0755 - 2575288 / 299 / 300  
 Fax : 0755 - 2579918
- CHHINDWARA**
- \* **Sunshine Motors**  
**Showroom & Workshop :**  
 College Road, Lalbagh, Chhindwara - 480 001  
 Tel. : 0716 - 244125, 244129, 244193 / 194  
 Fax : 0716 - 244126
- GWALIOR**
- \* **Sumedha Vehicles Pvt. Ltd.**  
**Showroom & Workshop :**  
 Opp. Jhansi Road Police Station,  
 Jhansi Road, Gwalior - 474 009  
 Tel. : 0751 - 2422067, 4015789, 3291856  
 Fax : 0751 - 2348024
- INDORE**
- \* **Super Cars Ltd.**  
**Showroom :**  
 Saket Tower - 3A, Ratlam Kothi,  
 Near Geeta Bhavan Square, AB Road, Indore - 452 001  
 Tel. : 0731 - 4700053, 54  
 Telefax : 0731 - 4700052
- Workshop :**  
 49, United Compound, Iasudiya Mori,  
 Dewas Naka, Indore  
 Tel. : 0731 - 470055, 56, 57  
 Fax : 0731 - 470054
- \* **Chhabra Autolink Pvt. Ltd.**  
**Showroom :**  
 Plot No.-10 Vishnupuri Main, Near Medisquare  
 Hospital, Indore - 452001  
 Tel : 0731 - 4267800
- Workshop :**  
 Plot No.- 11/11,11/12, Survey No.- 26, Gram Palada,  
 Khandwa Road, Indore - 452011  
 Tel : 0731 - 6656000
- JABALPUR**
- \* **Oriental Motors**  
**Showroom & Workshop :**  
 497, Karmeta, Near Padwar Kala,  
 Katangee Bye Pass Road, Jabalpur - 482 003  
 Tel. : 0761 - 3250007, 3260002, 3250003, 3290001  
 Fax : 0761 - 4027011

## 11-12 SERVICE NETWORK

★ **KHANDWA**  
**Bedi Motors**  
**Showroom & Workshop :**  
Gram Rehmapur, Indore Road, Khandwa - 450 001  
Tel. : 0733 - 2244075

★ **RATLAM**  
**Super Cars Ltd.**  
**Showroom & Workshop :**  
Jaora Road, Near RTO Office, Ratlam - 457 001  
Tel. : 07412 - 260040

★ **SAGAR**  
**Varenyam Motorcars Pvt. Ltd.**  
**Showroom :**  
Opposite Hotel Paradise, Jabalpur Road,  
Makroniya, Sagar - 470 004  
Tel. : 07582 - 263566

**Workshop :**  
Behind HDFC Bank, Makroniya  
Sagar - 470 004  
Tel. : 07582 - 239288

★ **SATNA**  
**Oriental Motors**  
**Showroom :**  
Virat Nagar Colony, Pateri, Panna Road, Satna - 485 001  
Tel. : 07672 - 229495

**Workshop :**  
27, Industrial Area Near Union Floor, Rewa Road,  
Satna - 485 001  
Tel. : 7672 -252763

### STATE - MAHARASHTRA

★ **AHMEDNAGAR**  
**Saideep Cars Pvt. Ltd.**  
**Workshop :**  
Survey No. 55/1B/2/1, Nagar Manmad Road,  
Ahmednagar - 414 111  
Tel. : 0241 - 2779225 - 7  
Fax : 0241 - 2779228

★ **AKOLA**  
**Star Motors**  
**Showroom & Workshop :**  
9/1, Geeta Nagar Near, Alankar Petrol Pump,  
Akola - 444 005  
Tel. : 07242800087 / 7350008428

★ **AMRAVATI**  
**Star Motors**  
**Showroom & Workshop :**  
Plot No. 8, Navathe Square Bandnera Road, Amravati  
Tel. : 0721 - 2510199, 9921008861, 7350008426

★ **AURANGABAD**  
**Mishrikotkar Motors LLP (Arihant Chevrolet)**  
**Showroom :**  
Sector P, Town Centre, Jalna Road, CIDCO,  
Aurangabad - 431 005  
Tel. : 0240-2482819

**Workshop :**  
Plot No.E-35, Chikalhana MIDC Area,  
Aurangabad - 431 006  
Tel. : 7745011919, 7745021919

★ **BARAMATI**  
**Mota Automotive Pvt. Ltd.**  
**Showroom & Workshop :**  
41 / 1 / B / 17, Nira Road, Kasba, Tehsil - Baramati,  
Dist - Pune - 413 102  
Tel. : 02112 - 222212, 220212

★ **CHANDRAPUR**  
**ND Cars Pvt. Ltd.**  
**Showroom & Workshop :**  
Gajanan Maharaj Mandir Square, Bapat Nagar,  
Nagpur Road, Chandrapur - 442 401  
Tel.: 07172 - 646344/22

★ **DHULE**  
**Jitendra Wheels Pvt. Ltd.**  
**Showroom & Workshop :**  
P-62, Behind Hotel Manas, MIDC Avdhan,  
Dhule - 424 001  
Tel. : 02562 - 281222 / 232

★ **JALGAON**  
**Soham Motors Pvt. Ltd.**  
**Workshop :**  
93/1, MIDC, RL Square Aurangabad Road,  
Jalgaon - 425 003  
Tel. : 0257-2211151, 2270085

★ **KOLHAPUR**  
**Unique Automobiles**  
**Showroom & Workshop :**  
122/1, Pulachi Shirolji, Opp. Sangli Phata,  
Kolhapur - 416 122  
Tel. : 0230 - 2461518 - 19  
Fax : 0230 - 2461520

**Showroom 2 :**  
Ayodhya Park, Opp. Sangam Talkies,  
Kavala Naka, Kolhapur - 416 001  
Tel. : 0231 - 2535315, 2535425  
Fax : 0231 - 2535615

★ **LATUR**  
**Ajinkya Cars Pvt. Ltd.**  
**Showroom & Workshop :**  
Barshi Road, Near Bidave Engineering College,  
Beside Pramod Petrol Pump, Latur - 413 531  
Tel. : 02382 - 222600

★ **MUMBAI**  
**Ashtavinayak Auto Pvt. Ltd.**  
**Showroom 1 :**  
D Mall, Off Veera Desai Road, Andheri (West),  
Mumbai - 400 053  
Tel. : 022 - 66488888  
Fax : 022 - 66488880

**Showroom 2 :**  
Shop no. 1 & 2, Poonam Heights Building,  
SV Road, Goregaon West, Mumbai - 4000062  
Tel. : 022 - 67822288

**Workshop :**

Ram Mandir Road, Somani Gram,  
Next to Central Warehouse Corporation,  
Oshiwara, Goregaon (West), Mumbai - 400 051  
Tel. : 022 - 26765555

\* **AVK Automart Pvt. Ltd.****Workshop :**

Fida Hussain Industrial Estate,  
Near Samrat Hotel, Pandurang Wadi Road,  
Mira Road (West), Mumbai - 401 104  
Tel. : 022 - 28453178, 28455507, 28453564

\* **Nikhil Automobiles Pvt. Ltd.****Showroom & Workshop 1 :**

A 70, TTC Industry Area, Thane Belapur Road,  
Kharghar, Near ICI Color Company,  
Khoparkaine West, Navi Mumbai - 400 709  
Tel. : 022 - 27780801, 40708888  
Fax : 022 - 40708899, 27780805

**Showroom 2 :**

264-265, Vaswani Chambers, Opp. Old Passport  
Office, Prabhadevi, Mumbai - 400 025  
Tel. : 022 - 434594444, 24221711-12  
Fax : 022 - 24222713

**Workshop 2 :**

C/o Bharat Tiles & Marbles Ltd.,  
Jaibhimnagar, Dharukhana Road, Reay Road (East),  
Near Sujala Hotel, Mumbai - 400 010  
Tel. : 022 - 64560303, 23774514 / 15 / 16  
Fax : 022 - 23774505

**Workshop 3 :**

Plot No. D - 238 - A, TTC Industrial Area,  
MIDC Shiravane, Nerul, Navi Mumbai - 400 706  
Tel. : 022 - 43448800

**NASIK**\* **Jitendra Wheels Pvt. Ltd.****Showroom & Workshop :**

B-88, Arihant Plaza, MIDC, Ambad, Next to Hotel Taj,  
Mumbai - Agra Highway, Nasik - 422 010  
Tel. : 0253 - 2384432 / 632 / 832, 6636666, 6637777  
Fax : 0253 - 2384532

**NAGPUR**\* **Star Motors****Showroom & Workshop :**

44 / 4, Wahajara, Kamptee Road,  
NH - 7, Nagpur - 440 026  
Tel. : 0712 - 6507836/37, 6507916, 6461503 / 04  
Fax : 0712 - 2632429

\* **Tajshree Motors Pvt. Ltd.****Showroom :**

Plot No. 1 Hindustan Colony, Wardha Road,  
Nagpur - 440 002  
Tel. : 0712 - 2250242 / 2250243 / 2250244

**Workshop :**

Plot No. 679, Ghat Road,  
Near Cotton Market Square, Nagpur - 440 018  
Tel. : 0712 - 2734466 / 2734467

**NANDED**\* **Bafna Automotives****Showroom & Workshop :**

Gut No. 235, Pimpalgaon (Mahadeo),  
Nanded - Akola Road, Nanded - 431 607  
Tel. : 02462 - 274069 / 652099, 311102

**PUNE**\* **Platinum Chevrolet****Showroom & Workshop 1 :**

Sr No 45/1/B/A, Shankarseth Road, Gutkewadi,  
Pune - 411 037  
Tel. : 020 - 26440029

**Showroom & Workshop 2 :**

Survey No 5/4, Najhate Nagar, Kalewadi Main Road,  
Thergaon, Pune - 411 033  
Tel. : 020 - 66326600, 66326632, 66326666

\* **Singh Cycle & Motor Co.****Showroom 1 :**

S. No. 38/4, Krishna Complex, Hadapsar Bypass  
Road, Near Radisson Hotel, Kharadi, Pune - 411 014  
Tel. : 020 - 32419385 / 32319526

**Showroom 2 :**

ICC Trade Centre, Showroom No. 4, Survey No. 403  
A/2, Seneapati Bapat Road, Pune - 411 016  
Tel. : 020 - 25666941 / 2 / 3 / 4

**Workshop 1 :**

Reality Warehousing Pvt. Ltd., Gate No. 1337 / 1,  
Pune Nagar, Wagholi, Pune - 412 307  
Tel. : 020 - 46609999

**Workshop 2 :**

Patel Tiles Compound, Sr.No. 42/1, Shivaji Nagar,  
Behind ST Bus Stand, Pune - 411 005  
Tel. : 020 - 32424202, 65270809, 7774010500

**SATARA**\* **Unique Automobiles****Showroom & Workshop :**

41, Mutha Colony, Sadar Bazar, Satara - 416 002  
Tel. : 09623225299

**SOLAPUR**\* **Mota Automotive Pvt. Ltd.****Workshop :**

MRC Cable India, A/20/6, MIDC Chincholi,  
Solapur - 413 255  
Tel. : 9272222233

**SANGLI**\* **Unique Automobiles****Showroom :**

442-3, Kulkarni Complex, 100 feet road,  
South Sivaji Nagar, Sangli - 416 416  
Tel. : 0233 - 2326544  
Fax : 0233 - 2326594

**Workshop :**

Kulkarni Complex, 100 Feet Road,  
Near MSEB Sub-Station, Sangli - 416 416  
Tel. : 0233 - 2326544  
Fax : 0233 - 2326594



## 11-14 SERVICE NETWORK

---

### YAVATMAL

- ★ **SARAS MOTORS**  
**Pobaru Marketing & Agencies Pvt. Ltd.**

**Showroom :**

Shop No. 5, 6, 7, 8 Udhog Bhavan,  
Dharwha Road, Yavatmal - 445 001  
Tel. : 07232 - 255991  
Fax : 07232 - 255992

**Workshop :**

Block No. B-16 MIDC (Lohara), Yavatmal - 445 001  
Tel. : 07798883816  
Fax : 07232 - 255992

### THANE

- ★ **SC Auto Corporation**

**Showroom :**

Modi House, Opp. to LIC Building, Naupada,  
Eastern Express Highway, Thane (West),  
Thane - 400 602  
Tel. : 022 - 67610000  
Fax : 022 - 67610209

**Workshop :**

Pioneer Estate Corporation, 133-134, Pokhran Road  
No.2, Opp. Oswal Park, Thane (West) - 400601  
Tel. : 022 - 66040000  
Fax : 022 - 66040102

- ★ **Angel Auto World Pvt. Ltd.**

**Showroom & Workshop 1 :**

Grishma garden, Gokhivare, Vasai East, Thane,  
Mumbai (Vasai) - 401208  
Tel :0250-6453030 /6061777

**Showroom & Workshop 2 :**

J-176, MIDC, Tarapur Road,  
Boisar (West) - 401505  
Tel. : 02525 - 655454 / 655353

- L **Nikhil Automobiles Pvt. Ltd.**

**Showroom & Workshop :**

Survey No. 6, Hissa No. 6, Manpada Gaon,  
Kalyan Shill Road, Dombivali (East) - 421 204.  
Tel. : 0251 - 3048888 / 3048899

## STATE - CHATTISGARH

### BILASPUR

- ★ **Swati Ventures**

**Showroom & Workshop :**

Besides Shiv Talkies, Old Bus Stand Road,  
Bilaspur - 495001  
Tel. : 7752 - 605500 / 605511

### RAIPUR

- ★ **Vardhaman Motors**

**Showroom & Workshop :**

9/1, Mahoba Bazar, GE Road, NH-6,  
Kumhari Dist. - Durg, Raipur - 492 001  
Tel. : 7489177999, 7883221999

**Showroom 2 :**

Ashoka Millenium, Ring Road,  
Raipur - 492 011  
Tel. : 7714030104, 7712410008

## SOUTH ZONE

## STATE - ANDAMAN &amp; NICOBAR

- \* **PORTBLAIR**  
**Group Engineers**  
**Showroom :**  
 Prem Nagar Junction, (SY No 1394/1),  
 Haddo Post Port Blair - 744 102  
 Tel. : 03192 - 230301, 242901

**Workshop :**  
 Opp Womens Working Hostel, Dollygunj,  
 Port Blair, Junglighat Post, Portblair - 744 103  
 Tel. : 03192 - 253044 / 253011

## STATE - ANDHRA PRADESH

- \* **BHIMAVARAM**  
**Orange Auto Pvt. Ltd.**  
**Showroom & Workshop :**  
 Door No. 2-25, # 6, Near Bharath petroleum bunk,  
 Undi Road, Bhimavaram - 534 202  
 Tel. : 9052781234 / 905224678

- \* **CHITTOOR**  
**M.G. Brothers Automobiles (P) Limited**  
**Showroom & Workshop :**  
 NH 4, Near Iruvaram Check Post, Chittoor - 517 001  
 Tel.: 92470 00003, 9247000027

- \* **GUNTUR**  
**Fusion Motors**  
**Showroom & Workshop :**  
 Plot No. 296 & 297, Opp. Sarvani Diesel Engineering,  
 Autonagar Main Road, Autonagar, Guntur - 522 001  
 Tel. : 0863 - 6454545

- \* **KURNOOL**  
**Dheeraj Motors**  
**Workshop :**  
 NH-7 Road, Near APS 2nd Battalian,  
 Ballary Chowrasta, Kurnool - 518 004  
 Tel. : 8518 - 253777

- \* **NELLORE**  
**M.G. Brothers Automobiles (P) Limited**  
**Showroom :**  
 26-2-1777, Near Ayyappa Temple, Vedayapalem Area,  
 Nellore - 524 004  
 Tel.: 9247000000

**Workshop :**  
 Plot No. 95 & 96, Wood Complex,  
 Near Ayyappa Temple, Nellore - 524 004  
 Tel. : 9247000022

- \* **RAJAHMUNDRY**  
**Orange Auto Pvt. Ltd.**  
**Showroom & Workshop :**  
 D. No. 82-10-2, Venkateswara Nagar,  
 Near Lalacheruvu, Near ONGC Complex, NH-5 Road,  
 Rajahmundry - 533 103  
 Tel. : 0883 - 6575555 / 6580888

- \* **TIRUPATHI**  
**M.G. Brothers Automobiles (P) Limited**  
**Showroom :**  
 11-46/A, Renigunta Road, Tirupathi - 517 501  
 Tel.: 9299999970

**Workshop :**  
 Plot No: 254, Auto Nagar,  
 Near Vinayaka Temple, Renigunta Road,  
 Tirupathi - 517 506  
 Tel.: 9247000024

- \* **VISHAKHAPATNAM**  
**Orange Auto Pvt. Ltd.**  
**Showroom & Workshop :**  
 D. No.38-22-87, Varun Avenue, NH-5, Murali Nagar,  
 NH. Birla Junction, Vishakhapatnam - 530 075  
 Tel.: 0891 - 2572222, 9052402345

**Showroom 2 :**  
 D. No. 4-46-12, G. K. Mansioni, Pedawaltier,  
 Vishakhapatnam - 530 017  
 Tel.: 0891 - 2572222, 4444  
 Fax: 0891 - 6645555

- \* **VIJAYWADA**  
**Fusion Motors**  
**Showroom :**  
 Fusion Towers, 36-12-2, Opposite to Siddhartha  
 Public School, Moghul Rajapuram,  
 Vijayawada - 520 010  
 Tel. : 0866 - 6645555 / 9603123666  
 Fax : 0866 - 6645592

**Workshop :**  
 Opposite to Fusion Towers, 36-12-2,  
 Near Siddhartha Public School, Moghul Rajapuram,  
 Vijayawada - 520 010  
 Tel. : 0866 - 6645593 / 94, 9603123777

## STATE - KARNATAKA

- \* **BANGALORE**  
**Kropex India Ltd.**  
**Showroom & Workshop :**  
 49/1, Singasandara, Hosur Main Road,  
 Bangalore - 560 068  
 Tel. : 080 - 43574357  
 Fax : 080 - 43574353

**Workshop 2 :**  
 Sy. No. 26, Hanumareddy Layout,  
 Chinnapanahalli Main Road, Marathahalli Post,  
 Bangalore - 560 037  
 Tel. : 9663388812

- \* **Trident Automobiles Pvt. Ltd.**  
**Showroom & Workshop :**  
 SY. No. 18/1B, (Old No 18/1C), Nayanda Halli Grama,  
 Kengeri Hobli, Bangalore - 560 038  
 Tel. :080 - 67149191/292, 67149001

**Showroom & Workshop 2 :**  
 No. 122/1, C. Shankar Reddy Layout, Kalyana Nagar,  
 Outer Ring Road, Bangalore - 560 043  
 Tel. : 080 - 43430300, 43430500  
 Fax : 080 - 43430308, 43430517

## 11-16 SERVICE NETWORK

### Showroom 3 :

No. 300 A - 70, 36th Cross, 10th Main,  
5th Block, Jay Nagar, Bangalore - 560 041  
Tel. : 080 - 42542999

### Workshop 3 :

No. 558/1,60 ft Road, 9th Cross, HAL 2nd Stage,  
Old Airport Road, Behind Leela Palace,  
Kodihalli, Indiranagar, Bangalore - 560 008  
Tel. : 080 - 49155858

- \* **K.H.T. Chevrolet (A Division Of Morzaria Real Tech Private Limited)**  
**Showroom :**  
No: 725, West of Cord Road, Rajajinagar,  
1st Stage, Mahalakshmi Layout, Bangalore - 560 086  
Tel. : 080 - 49363636

### Workshop :

No. 305, 5th Main Road, 2nd Cross, 4th Phase,  
Peenya Industrial Area, Bangalore - 560 058  
Tel. : 080 - 49353637

- \* **BELGAUM**  
**Bellad Enterprises Pvt. Ltd.**  
**Showroom & Workshop :**  
Shri Krishna Weaving Mill Compound,  
Venguaral Road, Vijaya Nagar, Belgaum - 591 108  
Tel. : 0831 - 2449556 / 557, 6514911  
Fax : 0831 - 2472209

- \* **BELLARY**  
**Bellad Enterprises Pvt. Ltd.**  
**Showroom & Workshop :**  
Near Bellary Rolling Mills, Anantpur Road,  
Bellary - 583 101  
Tel. : 08392 - 261234 / 5  
Fax : 08392 - 261235

- \* **DAVANGERE**  
**Modi Motors**  
**Showroom & Workshop :**  
#869/1-2, PB Road, Opposite Sai International Hotel,  
Davangere - 577 006  
Tel. : 08192 - 233896

### **GULBARGA**

- \* **VKG Motor World**  
**Showroom & Workshop :**  
Plot - 1&2, Survey No. 116/2, Behind Mahendrakar  
Complex, Kapnoor Humnabad Road,  
Gulbarga - 585104  
Tel. : 08472 - 224555  
Fax : 08472 - 258019

### **HUBLI**

- \* **Bellad Enterprises Pvt. Ltd.**  
**Showroom & Workshop :**  
Opp. NGEF, Rayapura, Dharwad,  
P. B. Road, Hubli - 580 025  
Tel. : 0836 - 2218338 / 39  
Telefax : 0836 - 2218337

### **MANGALORE**

- \* **Vibrant Motors**  
**Showroom :**  
Mont Tiera Apartments, Vivekanand Road,  
Kadri, Nantoor-Padav, Mangalore - 575004  
Tel.: 0824 - 2225544

### Workshop :

C/O Manjunath Retreading Works, Kulshekar  
Chowki, Near KMF Milk Dairy, Kulshekar,  
Mangalore - 575 005  
Tel. : 0824 - 2231202

### **MYSORE**

- \* **Dyuthi Motors Pvt. Ltd.**  
**Showroom & Workshop :**  
No. 201 / 1 & 2, Hunsur Road, Hinkal Village,  
Mysore - 570 017  
Tel. : 0821 - 4240500 - 16  
Fax : 0821 - 4241899

### **SHIMOGA**

- \* **Frontline Automobiles**  
**Workshop :**  
Shankar Muth Road, Shimoga - 577 201  
Tel. : 08182 - 229099  
Fax : 08182 - 229098

## STATE - KERALA

### **ALLEPPEY**

- \* **Geeyam Motors Pvt. Ltd.**  
**Showroom :**  
Koorayil Annex, Opp. Bhattachirapurayidom,  
Near MCH Junction, Alappuzha, Alleppey - 688 001  
Tel. : 0477 - 2238501

### **CALICUT**

- \* **German Motors**  
**Showroom & Workshop :**  
118-A, Chungam Junction, West Hill,  
Calicut - 673 005  
Tel. : 0495 - 2383680 / 81, 2383770 / 71  
Fax : 0495 - 3041100, 2381909

### **COCHIN**

- \* **Geeyem Motors Pvt. Ltd.**  
**Showroom & Workshop :**  
11/336, NH-47 Bye Pass, Nettor P.O.,  
Ernakulam, Cochin - 682 304  
Tel. : 0484 - 2703245 - 49, 3097100, 3097101  
Fax : 0484 - 2703244

### **KANJRAPALLI**

- \* **Geeyem Motors Pvt. Ltd.**  
**Showroom :**  
Near A K J M School, K K Road, Kanjirappally  
(Kottayam Dt.)  
Tel. : 0482 - 8201616

### **KANNUR**

- \* **German Motors**  
**Showroom & Workshop :**  
BP6-14A, Valapattanam, Kannur - 670 010  
Tel. : 0497 - 2774466 - 67, 3057200  
Fax : 0497 - 27744666, 3057200

### **KAYAKULAM**

- \* **Geeyam Motors Pvt. Ltd.**  
**Showroom & Workshop :**  
NH-47, Near MSM College, Kayakulam - 690 502  
Telefax : 0479 - 2446650

- KODANGULUR**  
 \* **Geeyem Motors Pvt. Ltd.**  
**Showroom :**  
 XII/ 121-122, Opp. Medicare Hospital,  
 Kottapuram PO, TKS Puram, Kodungalur - 680 667  
 Tel. : 0480 - 2803561 / 62
- KOTAYYAM**  
 \* **Geeyam Motors Pvt. Ltd.**  
**Showroom & Workshop :**  
 Karithas Junction, Thellakom P.O., Kotayyam-686016  
 Tel. : 0481 - 2792203  
 Fax : 0481 - 2792383
- KOLLAM**  
 \* **Deedi Motors**  
**Showroom :**  
 Post Office Junction, Pallimukku, Kollam - 691 010  
 Tel. : 0474 - 3257777 / 2725959  
 Fax : 0474 - 2725900
- Workshop :**  
 Cantonment, North Nagar, Pullikada, Kollam - 691001  
 Tel. : 0474 - 2750010 / 11
- KOTTAKKAL**  
 \* **German Motors**  
**Showroom & Workshop :**  
 260A, Palathara, Cherusola P.O., Kottakkal,  
 Malappuram  
 Tel. : 0494 - 2611666
- MUVATTUPUZHA**  
 \* **Geeyam Motors Pvt. Ltd.**  
**Showroom :**  
 Mackar Plaza, EEC Market Road, PNB Junction,  
 Muvattupuzha - 686 673  
 Tel. : 0485 - 606600, 2835272 / 73  
 Fax : 0485 - 2832554
- Workshop :**  
 902/903, Opp. Mackar Plaza, EEC Market Road,  
 PNB Junction, Muvattupuzha - 686 673  
 Tel. : 0485 - 2835272 / 73  
 Fax : 0485 - 2832554

- MUTTUM**  
 \* **Geeyem Motors**  
**Showroom & Workshop :**  
 SY NO: 70/15, 71/10, Thai Kkattukara P.O, N H Road,  
 Distt. Aluva, Muttum, Cochin - 683 106  
 Tel. : 0484 - 2632193 / 94 / 95 / 96 / 97
- PERINTHALMANNA**  
 \* **German Motors**  
**Showroom & Workshop :**  
 AP-IV 664F, Opp. ITC, Tirurkad,  
 Perinthalmanna - 679 531  
 Tel. : 04933 - 325060, 237000, 239878  
 Telefax : 04933 - 2737000
- PALAKKAD**  
 \* **Geeyam Motors**  
**Showroom & Workshop :**  
 Door No. 8/1198, NH Bypass Road,  
 Chandra Nagar, Palakkad - 678 007  
 Tel. : 0491 - 2504133  
 Fax : 0491 - 2504143
- PATHANAMTHITTA**  
 \* **Deedi Motors Pvt. Ltd.**  
**Showroom & Workshop :**  
 Kumbazhethu Buildings, Churulicode P.O.,  
 Kozhencherry Road, Pathanamthitta - 689 645  
 Tel. : 0468 - 2272079, 2272080  
 Fax : 0468 - 2272078
- THIRUVALLA**  
 \* **Deedi Motors Pvt. Ltd.**  
**Showroom :**  
 No. 54/2, Kurusumootil Buildings,  
 M C Road, Mazhuvangad, Thiruvalla - 689 101  
 Tel. : 0469 - 2740800
- THRISSUR**  
 \* **Geeyem Motors Pvt. Ltd.**  
**Showroom :**  
 14/3-A1, Guruvayoor Road Puzhakkal,  
 Ayyanthole P.O., Thrissur - 680 003  
 Tel. : 0487 - 2388945 - 46, 2388851 - 52  
 Fax : 0487 - 2388851

**Workshop :**  
 Near Boating Station, Puzhakkal Post Office,  
 Thrissur - 680 553  
 Tel. : 0487 - 2225100, 2225101

- TRIVENDRUM**  
 \* **Deedi Motors Pvt. Ltd.**  
**Showroom / Workshop :**  
 Erumalathopu, N.H. Bye Pass Road, Venpalvattom,  
 Anayara P.O., Trivendrum - 695 029  
 Tel. : 0471 - 2556006, 3257777, 2558599, 2558499  
 Fax : 0471 - 2551020

- WAYNAD**  
 \* **German Motors**  
**Showroom / Workshop :**  
 Muttil - Post, North Kalpetta, Waynad - 673 122  
 Tel. : 04936 - 304200 / 202414  
 Fax : 04936 - 304201

## STATE - PONDICHERRY

- PONDICHERRY**  
 \* **Aakash Auto Pvt. Ltd.**  
**Showroom :**  
 No. 1, Sounderrajan, 100 ft. Road, Sounder Rajan  
 Nagar, Mudaliarpatt, Pondicherry - 605 004  
 Tel. : 0413 - 2204400  
 Fax : 0413 - 2204033

**Workshop :**  
 No. 23, 9th Cross, Metupallyam,  
 Industrial Estate, Pondicherry - 605 009  
 Tel. : 0413 - 2279900

## STATE - TAMILNADU

- CHENNAI**  
 \* **Sundaram Motors**  
**Showroom & Workshop :**  
 180, Anna salai Road, Chennai - 600 006  
 Tel. : 044 - 28579203 / 28 / 32  
 Fax : 044 - 28579210

## 11-18 SERVICE NETWORK

### Workshop 2:

116/4 Mahalakshmi Nagar Extension,  
Numbal Village Thirverkadu Post, Chennai - 600 077  
Tel.: 044 - 26493020/21

### \* **KLN Motors Agencies Pvt. Ltd.**

#### Showroom 1:

Old No. 861, New No. 232, Poonamallee High Road,  
Kilpauk, Chennai - 600 010  
Tel : 044 - 23452937 / 38  
Telefax : 044 - 23452936

#### Workshop 1:

Shop No. 50, SIDCO Industrial Area,  
Ambattur, Chennai - 600 058  
Tel. : 044 - 23452930 - 32

#### Showroom & Workshop 2:

No. 8-NP, Developed Plot, Guindy Industrial Estate,  
Ekkattuthangal, Near Kasi Theatre, Chennai - 600 097  
Tel. : 044 - 23458941 / 42

### **CUDDALORE**

### \* **Aakash Auto Pvt. Ltd.**

#### Showroom & Workshop:

RS No.155/11, Vadalur Main Road, Periamedu,  
Karaikadu Village, Cuddalore Taluk, Cuddalore - 607 005  
Tel.: 04142 - 297997, 7373299933, 7373599933

### **COIMBATORE**

### \* **Anamallais Agencies (P) Ltd.**

#### Showroom:

252, Mettupalayam Road, Coimbatore - 641 043  
Tel. : 0422 - 2435555 / 2432999  
Fax : 0422 - 2446151

#### Workshop:

249A, Mettupalayam Bye Pass Road,  
Coimbatore - 641 043  
Tel. : 0422 - 2433444

### \* **Pressana Automobile**

#### Showroom:

No. 1987, Trichy Main Road, LCT Complex,  
Coimbatore - 641 005  
Tel. : 0422 - 4041111

#### Workshop:

505/1, Sowaripalayam Main Road,  
Ramanathapuram, Coimbatore - 641 045  
Tel. : 0422 - 4051111

### **ERODE**

### \* **Pressana Automobile**

#### Showroom & Workshop:

No.1, ChinnaKadu Thottam,  
Veerapampalayam, Dhindhal P.O., Erode - 638 012  
Tel. : 0424 - 2276046 / 47  
Fax : 0424 - 2276048

### **HOSUR**

### \* **Thrive Cars**

#### Showroom & Workshop:

S. No. - 321, Bathala Palli,  
SIPCOT - II, Hosur - 635109.  
Tel. : 04344 - 644588 / 9994099116

### **KARUR**

### \* **Pressana Automobile**

#### Showroom & Workshop:

No.3, Salem Bypass Road, Kulathupalayam,  
Karur - 635 006  
Tel. : 04324 - 222301  
Fax : 04324 - 222302

### **MADURAI**

### \* **A.R.A.S. Motors (P) Ltd.**

#### Showroom:

35/1, Dindigul National Highway,  
Near A. R. C. Parcel Service, Villangudi,  
Madurai - 625 018  
Tel. : 0452 - 2669617, 3091917  
Fax : 0452 - 2669618

### Workshop:

Plot No. 64 & 68, Thiruvallavanallur Post,  
National Highway No. 7, Opp Aroky Milk  
Processing Unit, Nagari, Madurai - 625 221  
Tel. : 0452 - 2463612 / 13 / 14

### **NAGERCOIL**

### \* **A.R.A.S. Motors (P) Ltd.**

#### Showroom & Workshop:

2/86, Tirunelveli Main road,  
Ozhuginasery, Nagercoil - 629 001  
Tel. : 04652 - 644664 (Showroom)  
04652 - 272443 (Workshop)

### **NAMAKAL**

### \* **Thrive Cars**

#### Showroom:

5/58, Salem Main Road, Namakal  
Tel. : 04286 - 275603

#### Workshop:

276/85, Tiruchengode Main Road,  
Opp. Old Lakshmi Kalyana Mandapam,  
Namakkal - 637 001

### **PUDUKOTTAI**

### \* **Jayaraj Karz**

#### Showroom & Workshop:

5915/1, Khalif Nagar, Thirumayam Road,  
Pudukottai - 622 001  
Tel. : 04322 - 262223

### **PERAMBALUR**

### \* **Jayaraj Karz**

#### Showroom & Workshop:

No. 36, Trichy to Chennai Highway, Erariyur,  
Veppanthattai, Perambalur, Tamilnadu - 621 133  
Tel. : 9244222728

- SALEM**  
 \* **Thrive Cars**  
**Showroom & Workshop :**  
 1116, Salem Chennai Highway Road,  
 Near Holy Cross, Hr. Sec. School,  
 Ammapet, Salem - 636 014  
 Tel. : 0427 - 2242603  
 Fax : 0427 - 2242604
- TRICHY**  
 \* **Jayaraj Karz**  
**Showroom & Workshop :**  
 Madurai Main Road, Panjapur, Trichy - 620 012  
 Tel. : 0431 - 2906420 / 6541207  
 Fax : 0431 - 2202187
- THIRUNELVELLI**  
 \* **A.R.A.S. Motors (P) Ltd.**  
**Showroom & Workshop :**  
 1183/3, National Highway Jothipuram,  
 Konganthanparai, Thirunelveli - 627 007  
 Tel. : 0462 - 2551070, 3269638  
 Fax : 0462 - 2554111
- TIRUPUR**  
 \* **Anamallais Agencies Pvt. Ltd.**  
**Showroom & Workshop :**  
 396/6, Kamaraj Road, Palladam Road,  
 Tirupur - 641 604  
 Tel. : 0421 - 2918999
- THANJAVUR**  
 \* **Jayaraj Karz**  
**Showroom & Workshop :**  
 Pudukottai Bye - Pass Road, Thanjavur  
 Tel. : 04362 - 226452
- VELLORE**  
 \* **Sayar Cars**  
**Showroom & Workshop :**  
 S.F. No. 3004, New By Pass Road,  
 Near Collectorate, Vellore - 632 004  
 Tel. : 0416 - 2222017

## STATE - TELANGANA

- HYDERABAD**  
 \* **Kun Automobiles (P) Ltd.**  
**Showroom & Workshop 1 :**  
 Plot No. 74, Snehapuri Colony, Near Andhra Bank,  
 Nagole Main Road, Nagole, Hyderabad - 500 035  
 Tel. : 040 - 24220013, 44886666, 44886767/700/701  
 Fax : 040 - 24220313
- Showroom 2 :**  
 House No. 1-3-1045, Viceroy Hotel Lane,  
 Kawadiguda Road, Hyderabad - 500 080  
 Tel. : 040 - 27532385 - 89  
 Fax : 040 - 27532384
- Workshop 2 :**  
 1-8-670, Azamabad, RTC 'X' Road,  
 Hyderabad-500020  
 Tel. : 040 - 27668678 / 27668761  
 Fax : 040 - 27668632
- Workshop 3 :**  
 Plot No. 21, Mini Industrial Estate,  
 Hafeezpet Road, Kondapur, Hyderabad - 500 049  
 Tel. : 040 - 31906677
- Workshop 4 :**  
 Plot No.37, Survey No.45,Vignan Junior College Road,  
 Kundapur, Hyderabad - 500 081  
 Tel. : 040 - 31906699
- \* **Orange Auto Pvt. Ltd.**  
**Showroom 1 :**  
 6-3-249/3, Abhinandan Towers, Road No. 1,  
 Banjara Hills, Hyderabad - 500 034  
 Tel. : 040 - 66515555  
 Fax : 040 - 66469999
- Workshop 1 :**  
 B-45/46, Industrial Estate, Near Andhra Bank  
 Sanatnagar, Hyderabad - 500 018  
 Tel. : 040 - 66265555 / 66269999

**Showroom & Workshop 2 :**  
 16-2-705/1/1, Malakpet, Opp. Srukrupa Market,  
 Hyderabad - 500 036  
 Tel. : 040 - 66815555  
 Fax : 040 - 66179999

**Showroom & Workshop 3 :**  
 A2, Balanagar Techno Craft Industrial Estate,  
 Balanagar, Hyderabad - 500 037  
 Tel. : 040 - 23721111  
 Fax : 040 - 23729999

**KARIMNAGAR**  
 \* **Kun Automobiles (P) Ltd.**  
**Showroom & Workshop :**  
 M.No.8-6-128, Kothi Rampur,  
 Hyderabad Highway Road,  
 Karim Nagar - 505 001  
 Tel. : 0878 - 2276633 / 9885520022  
 Fax : 0878 - 2276633

**KHAMMAM**  
 \* **Fusion Motors**  
**Showroom & Workshop :**  
 Plot No. 11, Sri Sri Circle, Opp. Reliance Petrol Bunk,  
 Rotary Nagar, Bypass Road, Khammam - 507 002  
 Tel. : 9247623666, 8096991122

**WARANGAL**  
 \* **Kun Automobiles (P) Ltd.**  
**Showroom :**  
 Door No. 15-2-4-1-1 & 15-2-4,  
 Mulugu Cross, Warangal - 506 007  
 Tel. : 0870 - 2421955  
 Fax : 0870 - 2421955

**Workshop :**  
 H. No. 23-6-132, Hunter Road,  
 Opp. Citizens Club, Warangal  
 Tel. : 0870 - 2523377 / 88 / 99  
 Fax : 0870 - 2523399

## EAST ZONE

### STATE - ARUNACHAL PRADESH

#### ITANAGAR

- \* **Sango Motors**  
**Showroom & Workshop:**  
NH-52A, Near Shiv Mandir, 6 Km  
Between Nahalagun, Dist. Papumpare  
Itanagar, Arunachal Pradesh - 791 110  
Tel. : 0360 - 2001166 / 67, 2033153

### STATE - ASSAM

#### BONGAIGAON

- \* **Raj N Dibyani Automobiles**  
**Showroom & Workshop:**  
Near Lower Assam Hospital, Chapaguri Road,  
North Bongaigaon, Bongaigaon  
Tel.: 03664 - 231890, 230545

#### DIBRUGARH

- \* **Pashupati Traders**  
**Showroom & Workshop:**  
P. N. Road, Chiring Chapori, Dibrugarh - 786 001  
Tel. : 0373 - 2323281  
Telefax : 0373 - 2323296

#### GUWAHATI

- \* **Srishti Automobiles Pvt. Ltd.**  
**Showroom:**  
Opp. Pantaloons, G S Road, Rukminigaon,  
Guwahati, Assam - 781 022  
Tel. : 0361 - 2223666  
Fax : 0361 - 2223888

#### Workshop:

Radha Nagar, VIP Road, Six mile, Guwahati,  
Assam - 781 022

#### JORHAT

- \* **Nova Automobiles**  
**Showroom & Workshop:**  
Pulibor, NH 37, PO: RRL, Jorhat - 785006  
Tel. : 0376 - 2370077

#### Workshop 2:

Nova Furniture Factory Compound,  
Milan Nagar, Jorhat - 785001  
Tel. : 0376 - 2309263

#### SHIBSAGAR

- \* **Pashupati Traders**  
**Showroom & Workshop:**  
KPM Chariali, Shivasagar, Shivasagar - 785 640  
Tel. : 03772 - 220082 / 88

#### SILCHAR

- \* **Smart Motors Pvt. Ltd.**  
**Showroom & Workshop:**  
NH-54, Ramnagar, Silchar - 788 008  
Tel. : 03842 - 268701, 9207042806

#### NAGAON

- \* **LB Motor (A Unit of Borah & Sons Pvt. Ltd)**  
**Showroom & Workshop:**  
AT Road, Dimarguri, Nagaon - 782 003  
Tel.: 03672 - 253157

#### TEZPUR

- \* **GNB Motors**  
**Showroom:**  
P.O. Nikamul, Beside Udyanpath,  
Tezpur - 784 001  
Tel. : 03712 - 255999

#### Workshop:

P.O. Nikamul, Udyanpath,  
Tezpur - 784 001  
Tel. : 03712 - 255998

#### TINSUKIA

- \* **Dhansri Motors**  
**Showroom & Workshop:**  
Opposite New Tinsukia Railway Junction,  
A.T. Road, Hijuguri, Tinsukia - 786 125.  
Tel. : 0374 - 2311397

### STATE - BIHAR

#### MUZAFARPUR

- \* **Pandey Motors Pvt. Ltd.**  
**Showroom & Workshop:**  
Mithila Body Builders, NH-18,  
Bhagwanpur, Muzafarpur - 842 001  
Tel. : 0621 - 2252762

#### PATNA

- \* **Pandey Motors Pvt. Ltd.**  
**Showroom:**  
Pandey Plaza, Exhibition Road, Patna - 800 001  
Tel. : 0612 - 2205195, 3955491  
Fax : 0612 - 2205196

#### Workshop:

Bhootnath Road, Sahadurpur, PS Agamkuan,  
Patna - 800 020  
Tel. : 0612 - 2341151

#### GAYA

- \* **Brijnandan Automobile Pvt. Ltd.**  
**Showroom & Workshop:**  
727 Old 1026 / New No. NH - 83,  
Near BMP - 3, Gaya - 823 004  
Tel. : 0631 - 2200131

#### PURNEA

- \* **Hare Krishna Motors Pvt. Ltd.**  
**Showroom & Workshop:**  
Damka Chowk, NH - 31, Gulabghagh, Purnea - 854 326  
Tel. : 9234323211

**STATE - JHARKHAND****BOKARO**

- \*
- Power Motors**

**Showroom & Workshop :**

N-1, City Centre, Sector - 4,  
Bokaro Steel City, Bokaro - 827 004  
Tel. : 06542 - 233555 / 232977  
Fax : 06542 - 232988

**DHANBAD**

- \*
- Sorabh Automobiles**

**Showroom :**

Indramani Palace, Opp Flair Bajaj, Saraidhela,  
Dhanbad - 826 001  
Tel. : 0326 - 2201366

**Workshop :**

Tilakraidih, Govindpur Road, Dhanbad - 826 001  
Tel. : 9470580855

**HAZARIBAGH**

- \*
- Laxmi Auto**

**Showroom & Workshop :**

Zulu Park Road, Near SBI Main Branch,  
Hazaribagh - 825 301  
Tel. : 06546 - 222929

**JAMSHEDPUR**

- \*
- Narbheram Motors Pvt. Ltd.**

**Showroom & Workshop :**

M-4, Phase-VI, Adityapur Industrial Area,  
P.O. Gamaria, Jamshedpur - 832 108  
Tel. : 0657 - 3293612, 3297763, 3290649, 6510531  
Telefax : 0657 - 2200532

**RANCHI**

- \*
- Rahul Automobiles Pvt. Ltd.**

**Showroom 1 :**

Piska More, Ratu Road, Ranchi - 834 005  
Tel. : 0651 - 2510251 / 52

**Showroom 2 :**

Line Tank Road, MR Tower, Ranchi - 834 001  
Tel. : 0651 - 3298436  
Fax : 0651 - 2510252

**Workshop :**

Ratu Road, Near Kamre Ashram, Ranchi - 834 005  
Tel. : 0651 - 2511558 / 564, 3241206

**STATE - ORISSA****BALASORE**

- \*
- Venus Auto Works Pvt. Ltd.**

**Showroom & Workshop :**

NH - 5, Remuna Golai, Januganj,  
Near Bhattar Mill, Balasore -756 019  
Tel. : 06782 - 244013, 244014

**BHUBANESWAR**

- \*
- Venus Auto Works Pvt. Ltd.**

**Showroom & Workshop :**

A/62, Nayapalli, Bhubaneswar - 751 003  
Tel. : 0674 - 3019999 (Showroom)  
0674 - 3019900, 3270444, 9337070444 (Workshop)  
Telefax : 0674 - 3019908

- \*
- Super Sales Automobiles Pvt. Ltd.**

**Showroom & Workshop :**

Plot No. 644/2148, NH-5, Pahal,  
Bhubneswar, Dist - khurda - 752 101  
Tel. : 0674 - 2463913, 2463914, 6543010 / 11

**SAMBALPUR**

- \*
- Bharat Motors Ltd.**

**Showroom & Workshop :**

9, Industrial Estate, Near Central School,  
Bareipali, Sambalpur - 768 006  
Tel. : 0663 - 2402736, 2405286  
Fax : 0663 - 2585894

**ROURKELA**

- \*
- Balaram Motors**

**Showroom & Workshop :**

Opposite Pahadi Kanta, Vedyash, Rourkela - 769 041

**STATE - WEST BENGAL****ASANSOL**

- \*
- Shailla Autotech**

**Showroom & Workshop :**

NH-2, Chanda More, Asansol - 713 339  
Telefax : 0341 - 2343704 / 705

**HOWRAH**

- \*
- Priti Motor Udyog (P) Ltd.**

**Showroom :**

NH-6, Bombay Howrah Highway, Howrah

**Workshop :**

Khejurtala Kolkata Truck Terminal,  
Khejurtala, NH-6, Howrah - 711 403  
Tel. : 033 - 65002070/71/72

**KOLKATA**

- \*
- OSL Autotech Pvt. Ltd.**

**Showroom :**

2/1A, Sarat Bose Road, Lansdowne Towers,  
Kolkata - 700 020  
Tel. : 033 - 66270400

**Workshop :**

49 E, Topsia Road South, Kolkata - 700 046  
Tel. : 033 - 66270500

- \*
- Speed Autotech**

**Showroom :**

"The Meridian", Kazi Nazrul Islam Sarani,  
(VIP Road), Kolkata - 700 059  
Tel. : 033 - 25007915 - 9  
Fax : 033 - 40150824

**Workshop 1 :**

241/2B, APC Road, Opp. Khanna Cinema,  
Kolkata - 700 004  
Tel. : 033 - 25551370 / 72 / 73 / 74, 25552509



## 11-22 SERVICE NETWORK

### Workshop 2:

108 F, Nilgunge Road, Agarpara, Kolkata - 700 058  
Tel. : 033 - 25552509

★ **Dulichand Motors Pvt. Ltd.**

### Showroom:

"Shrachi Towers", 686 Anandapur,  
E.M. Bypass, Near Ruby Hospital, Kolkatta - 700 107  
Tel. : 033 - 24431801 - 02, 40141616  
Fax : 033 - 40141624

### Workshop:

5/51, Jagatipota, Ahalya Nagar,  
Opp. Jagatipota Kisan Market, Kolkatta - 700 099  
Tel. : 033 - 40161718, 24264224, 24264214

○ **Longia Motors Pvt. Ltd.**

### Workshop 1:

15/1D, Sahanagar Road, (Near Rashbehari Avenue  
Crossing), Kolkatta - 700 026  
Tel. : 033 - 66270100 / 119  
Fax : 033 - 66270121

### Workshop 2:

Budge Budge Trunk Road, Rampur,  
P.O. : Gobindopur, P.S. : Maheshitala,  
Kolkata - 700 141  
Tel. : 033 - 66270222 / 223 / 205  
Fax : 033 - 66270208

### **SILIGURI**

★ **Kaysons Automotive Pvt. Ltd.**

### Workshop:

IIIrd Mile, Checkpost, Opp. New Eastern Bypass  
Road, Sevoke Road, Siliguri - 734 401  
Tel. : 0353 - 2544533 - 35, 2777723  
Fax : 0353 - 2544456

## STATE - MANIPUR

- ★ **IMPHAL**  
**Rajpri Enterprise**  
**Showroom & Workshop:**  
Chigmeirong Mamang Leikai,  
Imphal East, Imphal - 795 001  
Tel. : 0385 - 2421183

## STATE - NAGALAND

- DIMAPUR**  
★ **Urban Station**  
**Showroom & Workshop:**  
NSC Petrol Pump, NH-39, 6th Mile, Kohima Road,  
Dimapur, Nagaland - 797 112  
Tel. : 03862 - 240994, 240992

## STATE - TRIPURA

- AGARTALA**  
★ **Sri Krishna Automobiles**  
**Showroom & Workshop:**  
Plot No. 4612 & 4615, Shanihani,  
Airport Road, Agartala, Tripura West - 799 001  
Tel. : 0381 - 2342566

## STATE - MEGHALAYA

- SHILLONG**  
★ **DH Royal Cars**  
**Showroom & Workshop:**  
Parkview, Fire Brigade,  
Shillong - 793 014  
Tel. : 0364 - 2520481, 2520477

## STATE - SIKKIM

- GANGTOK**  
★ **GEN X Motors**  
**Workshop:**  
C/o Garima Enterprise, P.S. Road, Gangtok - 737 101  
Tel. : 03592 - 202515

## STATE - MIZORAM

- ★ **AIZAWL**  
**Highland**  
**Showroom & Workshop:**  
A-L Road, Zemabawk, Aizawl - 796 017  
Tel. : 0389 - 2351916

---

## INTERNATIONAL

### SRI LANKA

- \* **Mag City Motor Company Pvt. Ltd.**

**Showroom & Workshop:**

No. 320A, Darley Road,  
Colombo - 10, Sri Lanka  
Tel.: 0094777410407

### BHUTAN

- \* **Global Trade**

**Showroom:**

Lkahlilham, Changgankha,  
Thimphu, Bhutan

**Workshop:**

Post Box No. 1037, Olarongcchu,  
Thimphu, Bhutann

### NEPAL

- **SPG Automobiles Pvt. Ltd.**

**Workshop:**

GPO Box 2544, Khumaltar, Lalitpur,  
Kathmandu, Nepal  
Tel.: 00977-1-4100543





## Help us serve you better!

Any feedback / complaints / grievance send us or contact at:

General Motors India Private Limited

A-16, MIDC Talegaon Industrial Area (Phase-II), Near Floriculture Park,

Talegaon Navlakh Umbre Village Road, Tehsil-Maval,

Pune – 410507, Maharashtra, India.

Tel. +91 2114 663939

For Customer Assistance Centre call at +91 124 3080000 or email at [gmi.cac@gm.com](mailto:gmi.cac@gm.com)

24 Hr. Helpline at 1800 3000 8080

24 x 7 Roadside Assistance at 1800 103 8090 (Toll Free No.) or +91 124 4388090

### Disclaimer-

All information, illustrations and specifications contained in this Owner's Manual are based on the latest production information available at the time of publication. The right is reserved to make changes at any time without notice.

Part No.: 28287791

Revision No. 00

Revision Date

02/2015/280